



This is a digital copy of a book that was preserved for generations on library shelves before it was carefully scanned by Google as part of a project to make the world's books discoverable online.

It has survived long enough for the copyright to expire and the book to enter the public domain. A public domain book is one that was never subject to copyright or whose legal copyright term has expired. Whether a book is in the public domain may vary country to country. Public domain books are our gateways to the past, representing a wealth of history, culture and knowledge that's often difficult to discover.

Marks, notations and other marginalia present in the original volume will appear in this file - a reminder of this book's long journey from the publisher to a library and finally to you.

Usage guidelines

Google is proud to partner with libraries to digitize public domain materials and make them widely accessible. Public domain books belong to the public and we are merely their custodians. Nevertheless, this work is expensive, so in order to keep providing this resource, we have taken steps to prevent abuse by commercial parties, including placing technical restrictions on automated querying.

We also ask that you:

- + *Make non-commercial use of the files* We designed Google Book Search for use by individuals, and we request that you use these files for personal, non-commercial purposes.
- + *Refrain from automated querying* Do not send automated queries of any sort to Google's system: If you are conducting research on machine translation, optical character recognition or other areas where access to a large amount of text is helpful, please contact us. We encourage the use of public domain materials for these purposes and may be able to help.
- + *Maintain attribution* The Google "watermark" you see on each file is essential for informing people about this project and helping them find additional materials through Google Book Search. Please do not remove it.
- + *Keep it legal* Whatever your use, remember that you are responsible for ensuring that what you are doing is legal. Do not assume that just because we believe a book is in the public domain for users in the United States, that the work is also in the public domain for users in other countries. Whether a book is still in copyright varies from country to country, and we can't offer guidance on whether any specific use of any specific book is allowed. Please do not assume that a book's appearance in Google Book Search means it can be used in any manner anywhere in the world. Copyright infringement liability can be quite severe.

About Google Book Search

Google's mission is to organize the world's information and to make it universally accessible and useful. Google Book Search helps readers discover the world's books while helping authors and publishers reach new audiences. You can search through the full text of this book on the web at <http://books.google.com/>



GODFREY LOWELL CABOT SCIENCE LIBRARY
of the Harvard College Library

This book is
FRAGILE
and circulates only with permission.
Please handle with care
and consult a staff member
before photocopying.

Thanks for your help in preserving
Harvard's library collections.

ol.

T.

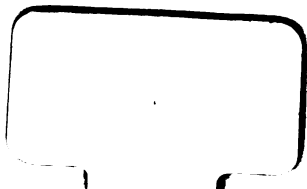

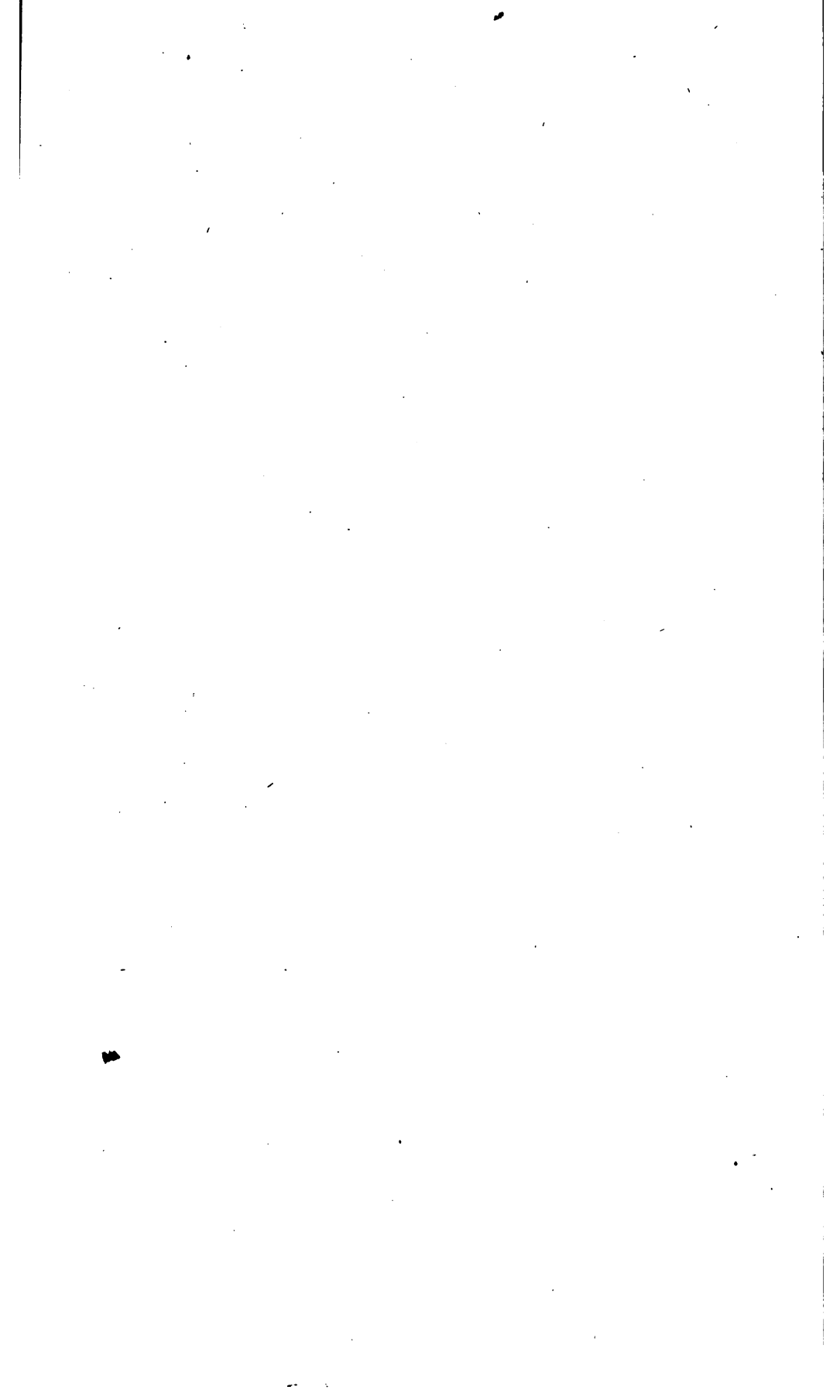

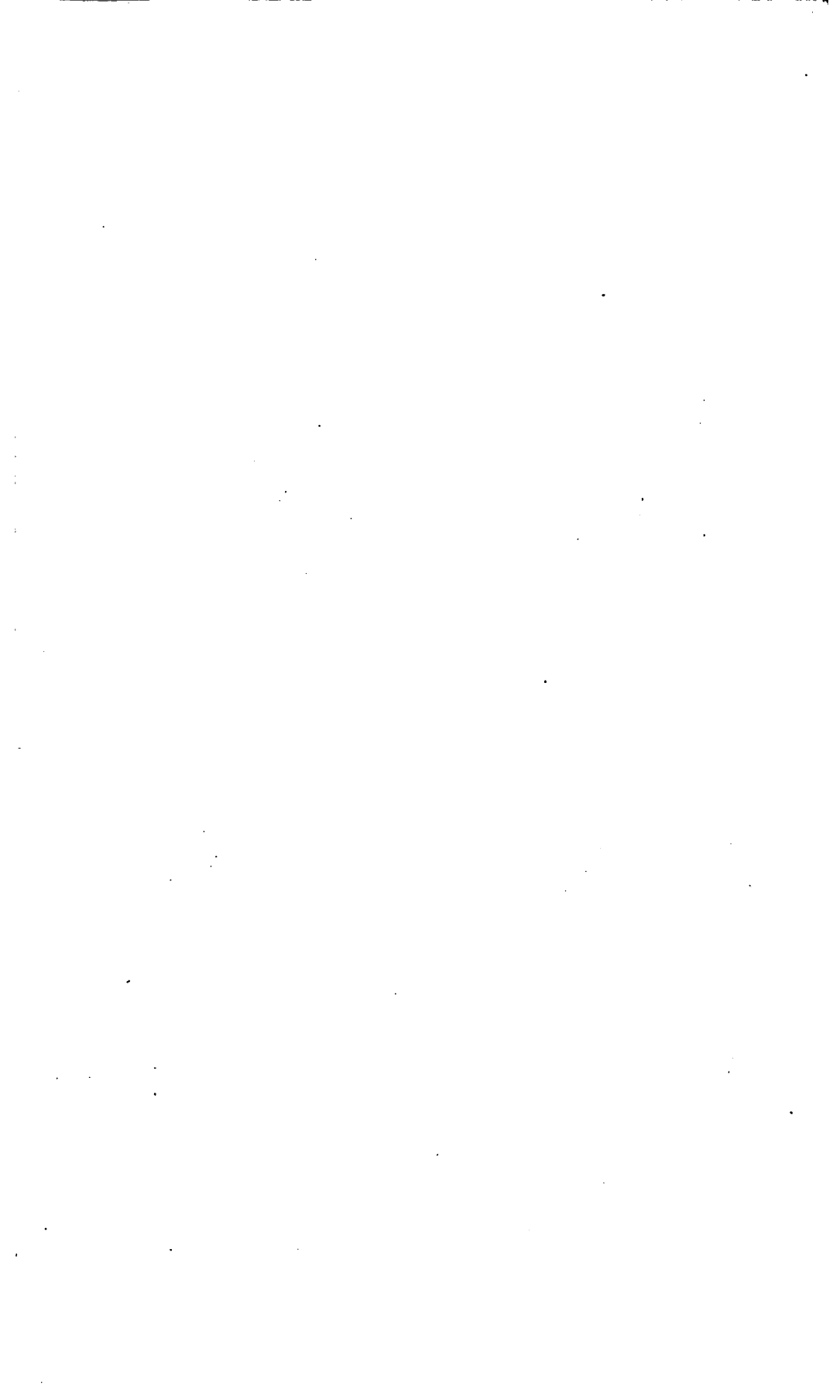

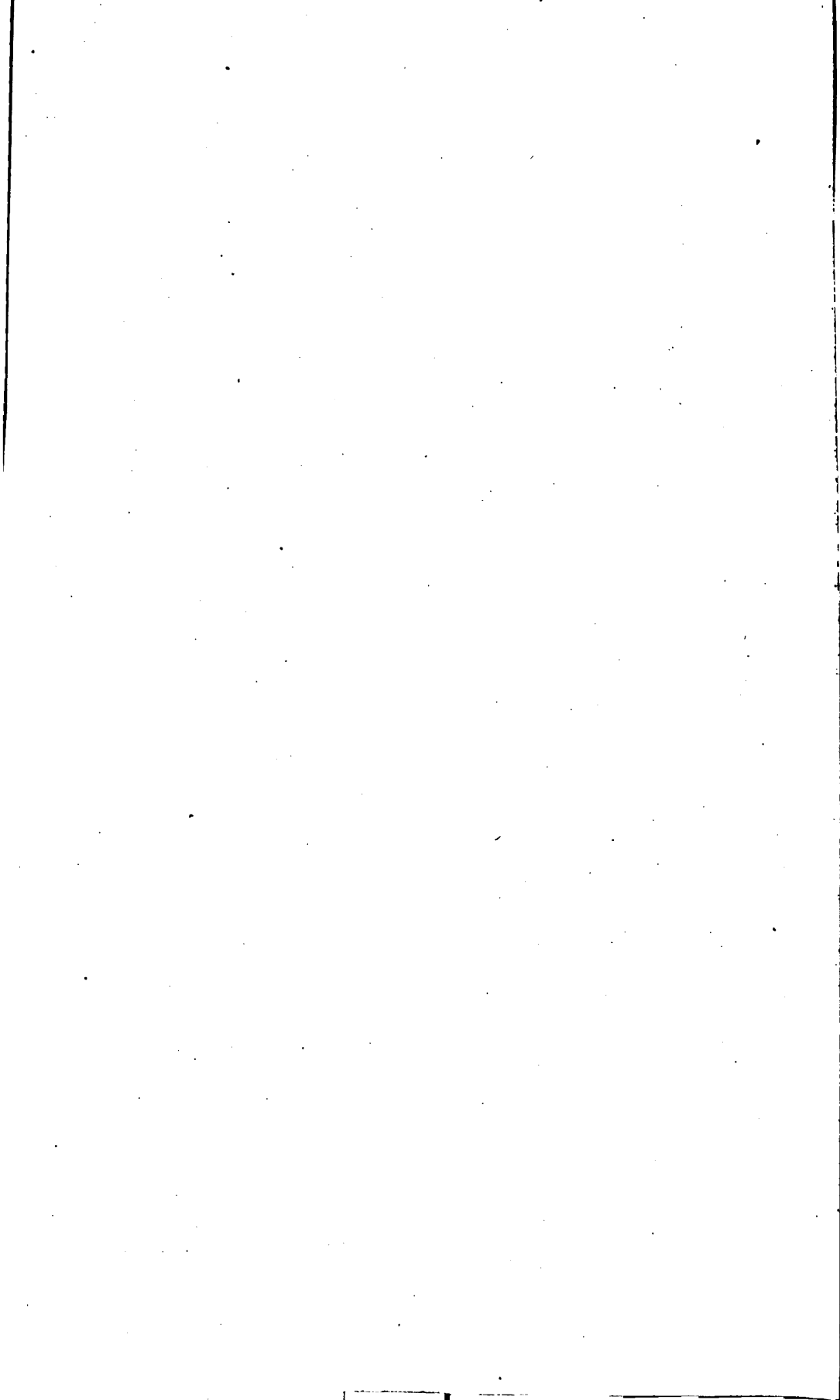

NOTES

ON

BUILDING CONSTRUCTION.

RIVINGTONS

London *Waterloo Place.*
Oxford *High Street.*
Cambridge *Trinity Street.*

NOTES

ON

BUILDING CONSTRUCTION

*ARRANGED TO MEET THE REQUIREMENTS OF
THE SYLLABUS OF THE SCIENCE & ART DEPARTMENT
OF THE COMMITTEE OF COUNCIL ON EDUCATION,
SOUTH KENSINGTON*

PART I.

FIRST STAGE OR ELEMENTARY COURSE

RIVINGTONS

London, Oxford, and Cambridge

MDCCCLXXV

Ena, 608.75
45.14

HARVARD UNIVERSITY
SCHOOL OF ENGINEERING

JUN 20 1917
TRANSFERRED TO
HARVARD COLLEGE LIBRARY

PREFACE.

THESE Notes have been compiled in order to assist students preparing for the examinations in Building Construction held annually under the direction of the Science and Art Department.

It is hoped that they may be found useful by others engaged in designing or erecting buildings.

The following Syllabus of the Science and Art Department has been taken as a guide in the arrangement of the Notes, and in determining the subjects to be treated upon.

SYLLABUS.

Subject III.—Building Construction.

As the object of this Course of Instruction is to lay the foundation of a sound knowledge of the principles, as well as of the practice, of Building Construction, and so lead the workman to labour with his head at the same time as with his hands, the teacher should not, necessarily, attempt to push the students through the whole of the subjects enumerated in this syllabus, but should limit the range of his tuition according to the time at his command and the intelligence of the pupils.

A larger number of questions will be set in the examination papers for the Elementary and Advanced stages, than the candidates will be allowed to attempt, so that he will, to a certain extent, be able to show his knowledge in such branches as he may, from circumstances, have paid special attention to. For instance, a student better acquainted with iron than wooden structures will be able to select a question on iron, in preference to one on wood, work. In order, however, to ensure that special attention shall not be given to work of one description

only, a certain number of the questions given, about one-half, will be compulsory, *i.e.* the candidate must attempt these, and unless he shows a sound knowledge of work of more than one kind, by answering a fair proportion of them, the rest of his paper will not be considered.

Moderately good drawing, showing an intelligent knowledge of the subject, will always be awarded higher credits at the examination than more highly finished drawings, exhibiting an ignorance of constructive details.

FIRST STAGE, OR ELEMENTARY COURSE.

It is assumed that the student has already mastered the use of the following drawing instruments:—rulers, ordinary and parallel; ruling pen, compasses, with pen and pencil bow-sweeps, as well as the construction and use of simple scales, such as 1, 2, 3, or more feet to the inch, showing inches; or such as $\frac{1}{2}$, $\frac{1}{3}$, $\frac{1}{4}$, $\frac{2}{3}$, $\frac{3}{4}$, $\frac{5}{8}$, or other fraction of full size, or of any given scale or drawing; and the meaning of such terms as plan, elevation (front, back, or side), section, sectional elevation.

He should understand the object of bond in brickwork, *i.e.* English bond, Flemish bond, or English bond with Flemish facing, and how it is attained in walls up to three bricks thick, in the following instances—viz. footings with offsets, angles of buildings, connection of external and internal walls, window and door openings with reveals and square jambs, external gauged arches (camber, segmental, and semicircular), internal discharging arches over lintels, and inverted arches.

He should know where to put wood bricks, or plugging, and their use; the construction and uses of brick corbeling, and the construction of trimmer arches in fireplaces.

He should be able to give sections and elevations to scale of the following kinds of masons' work—viz. uncoursed and coursed rubble, block in course, and ashlar, with their bond, and the proper dimensions of the stones, as to height, width of beds, and length; and of the following dressings—viz. window sills, window and door jambs, plain window and door heads, door steps, string courses, quoins, copings, common cornices, blocking courses; and of the following methods of connecting stones—viz. by cramps, dowels, joggles, and lead plugs.

He should be able to show how to join timbers by halving, lapping, notching, cogging, scarfing, fishing, and mortise and tenon; as applied to wall plates, roof timbers, floors, ceilings, and partitions.

He should be able to draw, from given dimensions, couple, collar, and king post roofs, showing the details of the framing and of the iron-work.

He should be able to draw, from given dimensions, single, double, and framed floors, with or without ceilings beneath them; showing modes of supporting, stiffening, and framing the timbers, trimming round hearths and wells of stairs; also floor coverings of boards or

battens, rebated and filleted, ploughed and tongued, and laid folding, with straight or broken joints, bevelled or square heading joints.

He should be able to draw in elevation, from given dimensions, a framed partition with door openings.

He should be able to draw in elevation, and give vertical and horizontal sections of, solid door frames and window frames.

He should be able to describe, by drawings, beadings of different kinds, dovetailing, cross-grooving, rebating, plough-grooving, chamfering, rounded nosing, and housings.

He should be able to draw in elevation, and give vertical and horizontal sections of, the following doors—viz. ledged, ledged and braced, framed and braced, panelled, and the mode of putting them together, position of hinges and furniture; as well as to describe, by drawing, the following terms as applied to panelled doors—viz. square and flat, bead butt, bead flush, moulded, all on one or both sides.

He should be able to draw in elevation, and to give vertical and horizontal sections of, the following window sashes and frames—viz. single or double hung sashes with square, bevelled, or moulded bars, and cased frames; casement sashes hung to solid frames, with method of hanging and securing in each case.

He should be able to show, in elevation and section, the lead work connected with chimneys, ridges, hips, valleys, gutters, and lead flats.

He should be able to give an elevation and section of the slating of a roof laid with duchess or countess slates on boards or battens.

He should be acquainted with the proper cross section for cast-iron beams for use in floor girders or bresssummers, or as cantilevers; and be able to draw such a section in its right proportions from given dimensions of flanges.

He should be able to draw in elevation, from given dimensions and skeleton diagrams, ordinary iron roofs up to 40 feet span, showing the sections of different parts, and methods of connecting them.

SECOND STAGE, OR ADVANCED COURSE.

In addition to the subjects enumerated for the Elementary Course—in all of which questions of a more complicated nature may be set, combining work done by the different trades—the knowledge of the students will be tested under the following heads, viz.—

1st. Freehand sketches explanatory of any details of construction, such as the joints of iron and wooden structures, and other parts requiring illustration on an enlarged scale. These sketches may be roughly drawn, provided they are clear and capable of being readily understood.

2d. The nature of the stresses to which the different parts of simple structures are subjected, as follows:—

In the case of beams fixed at one end, such as cantilevers, and fixed at both ends, or supported at both ends, as in girders, the

student should know which side of the beam is in compression, and which in tension.

He should be acquainted with the best forms for struts, ties, and beams, such as floor joists, exposed to transverse stress.

He should know the difference in the strength of a girder carrying a given load at its centre, or uniformly distributed.

In the ordinary kinds of wooden or iron roof trusses, and framed structures of a similar description, he should be able to distinguish the members in compression from those in tension.

3d. The nature, application, and characteristic peculiarities of the following materials in ordinary use for building purposes, viz.—

Bricks of different kinds in common use, York, Portland, Caen, and Bath stones (or stones of a similar description), granite, pure lime, hydraulic lime, Portland and Roman cement, mortars, concretes, grout, asphalt, timber of different kinds in common use, cast and wrought iron, lead.

4th. Constructive details, as follows :—

The ordinary methods of timbering excavations, such as for foundations to walls, or for laying down sewers ; the erection of bricklayers' and masons' scaffolding ; the construction of travellers ; the use of piles in foundations, hoop iron bond in brickwork, diagonal and herring-bone courses in ditto, damp-proof courses, bond timber in walls and the objections to it.

He should know how bricks are laid in hollow walls, window or door openings with splayed jambs, flues, chimneys, fireplaces, and arches up to about 20 feet span ; how mortar joints are finished off, and the thickness usually allowed to them ; why bricks and stones ought to be wetted before being laid.

He should be acquainted with the construction of brick ashlar walls, rubble ashlar walls, stone stairs, wooden stairs (both dog-legged and open newel), skylights, fire-proof floors (such as brick arches supported on rolled or cast-iron girders, Fox and Barrett's, and Dennett's patent concrete floors), circular and egg-shaped drains, roofs of iron or wood, for spans up to 60 feet ; the fixing of architraves, linings, and skirtings to walls, shutters to windows, lath, plaster, and battening to walls, roof coverings of tiles and zinc, slate ridges and hips.

Written answers will be required to some of the questions.

EXAMINATION FOR HONOURS.

The candidate will have to furnish a design for a building, or part of a building, in accordance with given conditions ; which design he will be allowed to draw out at his own home.

He will be called upon to answer in writing—illustrated by sketches, either freehand or to scale, as directed—questions on all the subjects previously enumerated for the Elementary and Advanced courses.

He must possess a more complete knowledge of building materials, their application, strength, and how to judge of their quality; and in the case of iron, of the processes of manufacture, and the points to be attended to in order to insure sound castings and good riveting.

He must be able to solve simple problems in the theory of construction, such as in the case of a beam supported at both ends, to ascertain the proportion of the load transmitted to each point of support, and to determine the safe dimensions of iron or wooden beams subjected to dead loads.

In ordinary roof trusses and framed structures of a similar description, he must be able to trace the stresses, brought into action by the load, from the points of application to the points of support, as well as to determine the nature and amount of the stresses on the different members of the truss, and, consequently, the quantity of material required in each part.

In ordinary walls and retaining walls, he must be able to ascertain the conditions necessary to stability, neglecting the strength of the mortar.

In these Notes the subjects of the above Syllabus will be divided as follows:—

PART I. will treat on all the points laid down as necessary for the examination in the First Stage, or Elementary Course.

PART II. will contain further instruction on the same subjects, and will also include those mentioned in the Syllabus for the Second Stage, or Advanced Course, with the exception of a few reserved for Part III., and specified below.

PART III. will contain instructions regarding “the nature of stresses to which the different parts of simple structures are subjected,” “the nature, application, and characteristics of the materials used in buildings,” together with notes on foundations, timbering excavations, scaffolding, travellers, etc.

With regard to the Examination for Honours, Part III. will give all the information required regarding materials; but the art of designing buildings from given conditions, and the problems involved in the theory of construction, must be studied in works specially devoted to those subjects.

In order to make these Notes useful to students throughout the country, many of the Scotch and Irish technical terms, where they differ from those in ordinary use in England, have been given in footnotes.

NOTES ON BUILDING CONSTRUCTION.

Note to Part I.

IN considering the subject of Building Construction, the most natural and convenient course would, perhaps, be first to describe the materials in use for building, and then to explain the forms and methods in which they are used.

As these Notes, however, are intended to aid in preparation for a particular Course, the order of subjects laid down in the Syllabus for that Course will be followed as nearly as possible, and the description of materials will be left for the latter part of the Advanced Stage, which is treated upon in Part III.

It is hoped that the student will find that the very slight general knowledge of building materials which he must be assumed to possess, will enable him to understand all that is brought before him in this Part.

The compiler of these Notes has endeavoured as far as possible to acknowledge his indebtedness, wherever he has taken information or illustrations from any published works. It has been impracticable to do this in every case, and it would be difficult to give a long list of all the authorities consulted.

Special mention should, however, be made of the works named below, whence much assistance has been derived, and to which the student may be referred for more extensive information regarding the subjects herein treated upon.

Dempsey's Builder's Guide.

Dempsey's Iron Roofs.

Gwilt's Encyclopædia of Architecture.

Hurst's Architectural Surveyor's Hand-Book.

Laxton's Examples of Building Construction.

Molesworth's Pocketbook of Engineering Formulæ.

Newland's Carpenter's and Joiner's Assistant.

Nicholson's Carpenter's Guide.

Pasley's Practical Architecture (Brickwork).

Rankine's Civil Engineering.

Seddon's Notes on the Building Trades and Building Construction.

Tredgold's Carpentry (1870 edition); also a new, valuable, and greatly extended edition by Mr. Hurst, C.E.

Unwin's Wrought-Iron Bridges and Roofs.

Wray's Application of Theory to the Practice of Construction.

The Professional Journals.

Caution.—Some of the drawings, which appear to be isometrical projections, must not be measured to scale, as they are purposely distorted in order to bring important points into view.

CONTENTS OF PART I.

CHAPTER I.

WALLING AND ARCHES.

WALLS.—*General Remarks—Bond—Headers—Stretchers.*

ARCHES.—*Names of Parts—Different Forms of Arch—Inverted Arches.*

PARTS OF WALLS.—*Footings—Quoins—Coping—Cornice—Blocking Course—Parapet Wall—Balustrade—Eaves Course—Plinth—String Course—Corbelling.*

APERTURES IN WALLS.—*Heads—Jambes—Reveals—Sills—Window Sills—Door Sills.*

WOOD BUILT INTO WALLS.—*Wall Plates—Templates—Wood Lintels—Bressummers—Wood Bricks—Wood Slips—Wood Plugs—Pallette Bricks—Substitutes for Wood Bricks.* Pages 1-11

CHAPTER II.

BRICK WORK.

General Remarks—Size of Bricks—Meaning of Terms—Bond—Closers.

DIFFERENT BONDS.—*Heading Bond—Stretching Bond—English Bond—English Bond with Broken Transverse Joints—Flemish Bond—Double Flemish Bond—Double Flemish Bond with False Headers—Single Flemish Bond—Comparison of English and Flemish Bond—Inferior Forms of English Bond.*

JUNCTION OF WALLS AT RIGHT ANGLES.—*Salient Angles—Re-entering Angles—Junction of Brick and Stone Work.*

GAUGED WORK.

BRICK ARCHES.—*Rough Brick Arches—Axed Arches—Gauged Arches.*

ARCHES OVER OPENINGS IN EXTERNAL WALLS.—*Segmental Face Arch—Semicircular Arch—Straight Arch—French or Dutch Arches.*

ARCHES OVER OPENINGS IN INTERNAL WALLS.

JAMBES OF WINDOW AND DOOR OPENINGS.—*Reveals with Square Jambes—Reveals with Splayed Jambes.*

PARTS OF BRICK WALLS.—*Footings—Quoins—Coping—Cornices—Eaves Courses—Corbelling—String Course* 12-36

CHAPTER III.

MASONRY.

WALLING.—*Classification—General Remarks—Ashlar—General Remarks—Coursed—Random—Rubble—General Remarks—Random—Squared—Coursed—Dry—Flint—Rustic—Lacing Course—Block in Course—Ashlar Facing.*

STONE ARCHES.—*Ashlar—Rubble.*

JOINTS AND CONNECTIONS.—*Metal—Dowelled—Joggled—Grooved and Tongued—Metal Cramps—Lead Plugs—Rebated—Tabled.*

DRESSINGS.—*Quoins—Second Quoins—Window Sills—Jamb—Lintels—String Courses—Corbels—Eaves Courses—Copings—Saddle-back Coping—Feather-edged Coping—Copings for Rubble Walls—Skew Corbel—Saddlestone—Cornices—Cornice and Blocking Course—Cornice and Balustrade—Cornice and Parapet Wall* Pages 37-55

CHAPTER IV.

CARPENTRY.

JOINTS AND FASTENINGS.—*General Remarks.*

CLASSIFICATION.—*Joints—Fastenings.*

JOINTS.—*Lapping—Fishing—Scarving—General Remarks—Different Forms of Scarf—Halving—Bevelled Halving—Dovetails—Dovetail Halving—Notching—Double Notching—Dovetail Notch—Tregold's Notch—Cogging—Mortise and Tenon Joint—Common Tenon—Tusk Tenon—Double Tenon—Stub Tenon—Housing—Dovetail Tenon—Notched Tenon—Oblique Tenon—Chase-mortises—Circular Joints—Bridle Joints—Post and Beam Joints—Strut and Beam Joints—Tie and Brace Joints—Suspending Pieces—Wedging—Fox Wedging—Keys.*

FASTENINGS.—*Pinning—Nails—Spikes—Trenails—Screws—Bolts—Washers—Plates—Straps—Heel-Straps—Branched Straps—Cast-iron Shoes, Sockets, etc.—Tie-beam Plates—Shoe for Foot of Rafter—Double Shoe—Socket Pieces* 56-81

CHAPTER V.

FLOORS.

Classification—Single Floors—Double Floors—Framed Floors—Timber Girders—Wall Plates—Templates—Common Joists—Strutting—Herring-Bone—Key—Pugging—Trimming—Floor Boards—Different Joints—Headings—Broken Joint Floors—Straight Joint Floors—General Remarks—Folded Floors—Floors in Two Thicknesses—General Remarks on Floors—Parquet Floors—Floors of Short Timber—Ceiling Joists—Brandering—Sizes for Floor Timbers 82-102

CHAPTER VI.

PARTITIONS.

*General Remarks—Quartered Partitions—Framed without Doorway—
With Ordinary Doorway in Centre—With Wide Doorway in Centre
—With Side Door—Common Partition—Bricknogged Partition*

Pages 103-107

CHAPTER VII.

TIMBER ROOFS.

*Flat Roof—Pitch of Roof—Couple Roof—Couple-Close Roof—Scantlings
for Couple-Close Roofs—Collar-Beam Roofs—Scantlings for Collar-
Beam Roofs—King-Bolt Roof without Struts—King-Post Roof.*

*PARTS OF A KING-POST ROOF.—Wall Plates—Templates—Tie Beam—
King Post—Suspending Pieces—Struts—Principal Rafters—Purlins—
Ridge Piece—Common Rafters—Roof Boarding—Battens—Pole Plates
Ceiling Joists—Eaves—Gutters—Sizes of Roof Timbers—Scantlings for
King-Post Roofs.*

*ROOFS OF WOOD AND IRON COMBINED.—King-Bolt Roof (Wooden Tie)—
King-Bolt Roof (Iron Tie)—Collar-Beam Roof—Trussed Rafter Roof—
Queen-Bolt Roof 108-127*

CHAPTER VIII.

IRON ROOFS.

General Remarks—Classification—Corrugated Iron Arched Roof.

*ROOFS WITH STRAIGHT RAFTERS.—Common Trussed Rafter Roof—Trussed
Rafter with two Struts—Queen-Rod Roofs.*

*PARTS OF IRON TRUSSES.—Principal Rafters—Tie Rods—Cottered Joints
—Suspending Rods—Struts—Purlins—Heads—Coverings for Iron Roofs
—Pitch of Iron Roofs—Scantlings of Trussed Rafter Roofs—Scantlings
of Wrought-Iron Queen-Rod Roofs—General Remarks 128-141*

CHAPTER IX.

SLATING.

*Pitch—Names of Parts—Preparing and laying Slates—Nailing Slates—
Eaves and Ridge Courses—Hips and Ridges—Slate Fillets—Slate
Ridging—Tile and Pottery Ridging—Slating for Iron Roofs—
Shouldering—Rendering—Torching—Sizes and Weights of Slates—
Wyatt's Patent Slating—Slate Slabs—Ornamental Slating—Open
Slating 142-149*

CHAPTER X.

PLUMBERS' WORK.

Laying Sheet Lead—Rolls—Hollow Rolls—Nosings—Hollow Nosings—Seams—Lapped Joints—Drips—Bottlenose Drips—Fixing Lead to Masonry—Raglet—Wedges, Wall-hooks—Burning in—Lead Dots—Flashings—Apron—Chimney Apron—Horizontal Flashings—Raking Flashings—Stepped Flashings—Soakers—Tingles—Lead Gutters—Bridged Gutters—Stone Gutter lined with Lead—Cesspools—Iron Gutters—Eaves Gutters—Iron Valley Gutters—Zinc Gutters—Down Pipes—Ridges and Hips—Valleys—Substitutes for Lead Flashings—Cisterns Pages 150-167

CHAPTER XI.

CAST-IRON GIRDERS, BRESSUMMERS, AND CANTILEVERS.

168-169

CHAPTER XII.

JOINERY.

General Remarks—Beadings—Shooting—Scribing—Rebating—Chamfering—V-Joint—Stop Chamfer—Housing.

JOINTS.—*Plain or Butt—Dowelled—Grooved and Tongued—Match-Boarding—Plough Grooving—Cross Grooving—Slip Feathers—Ploughed and Tongued—Grooved and Feathered—Dovetailed Slip Feathers—Beaded Joints—Dovetail Joints—Common Dovetail Joints—Mitred, Secret, and Lap Dovetails—Mortise and Tenon Joints—Haunching—Double Tenons—Stump Tenons.*

FRAMING.—*Panelling—Square Panels—Moulded Panels—Flush Panels—Solid Panels—Bead-flush Panels—Bead-butt Panels—Reed-flush Panels—Grooved Panel—Chamfered or V-Jointed Panel—Raised Panel.*

DOORS.—*Ledged Door—Ledged and Braced Door—Framed and Braced Door—Framed and Ledged Door—Panelled Doors—Method of Putting a Door together—Different Descriptions of Panelled Doors—Folding Doors—Double-Margined Doors—Sash Doors—Jib Doors—Sliding Doors—Door Frames—Solid Door Frames.*

WINDOWS.—*Solid Window Frame—Sash—Fixed Sashes—Fanlights—Sashes hung on Centres—Sliding Sashes in Cased Frames—Cased Frames with Double-hung Sashes in a Thick Wall—Cased Frame with Double-hung Sashes in a Thin Wall—Fixing Cased Frames in Position—Single-hung Sashes—French or Casement Windows—Furniture and Hinges—For Doors—For Windows* 170-208

CHAPTER I.

WALLING AND ARCHES.

WALLS.

General Remarks.—Walls are required as boundaries;¹ to retain earth or water; or, in buildings, to support the roof and floors, and to keep out the weather.

They are generally built either of brick or stone, and will be considered more in detail under the heads of "Brickwork" and "Masonry" respectively. The following points, however, should be attended to in walls of every description:—

The whole of the walling of a building should be carried up simultaneously; no part should be allowed to rise more than about 3 feet above the rest, otherwise the portion first built will settle down and come to its bearings before the other is attached to it, and then the settlement which takes place in the newer portion will cause a rupture, and cracks will appear in the masonry. If it should be necessary to carry up one part of a wall before the other, the end of the portion first built should be "racked back"—that is, left in steps, each course projecting farther than the one above it.

Work should not be hurried unless done in cement, but given time to take its bearings gradually.

New work built in mortar should never be bonded to old, until the former has quite settled down. Then bonds may be inserted if required.

As a rule, it is better that the new work should butt against the old, either with a straight joint visible on the face, or let into a chase,² so that the straight joint may not show; but if it be necessary to bond them together, the new work should be built in a quick-setting cement, and each part of it allowed to harden before being weighted.

¹ *Sc. Dykes.*

² Sometimes called a *slip joint.*

Even after walls are completed, they are likely to crack if unequally loaded.

The walls of a building should either be perfectly vertical, or at the required "batter" or inclination, and each course should be laid level in every direction, except in inclined or "battering" walls, when the courses should be at right angles to the line of inclination of the wall.

Bond¹ is an arrangement of bricks or stones placed in juxtaposition, so as to prevent the vertical joint between any two bricks or stones falling into a continuous straight line with that between any other two.

This is called "breaking joint," and when it is not properly carried out—that is, when two or more joints do fall into the same line, as at *x y*—they form what is called a *straight joint*.

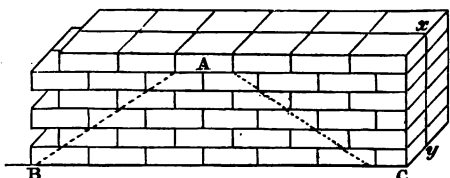

Fig. 1.

Straight joints split up and weaken the part of the

wall in which they occur, and should therefore be avoided.

A good bond breaks the vertical joints both in the length and thickness of the wall, giving the bricks or stones a good lap over one another in both directions, so as to afford as much hold as possible between the different parts of the wall.

A further effect of the bond is to distribute the pressure which comes upon each brick over a large number of bricks below it. Thus, in Fig. 1, there is a proper bond among the bricks forming the face of the wall, and the pressure upon the brick A is communicated to every brick within the triangle A B C.

A defective bond, either in brickwork or masonry, may look very well upon the face, as in Fig. 1, where the bricks regularly break joint vertically, but in which there is no bond whatever across the thickness of the wall, which it will be seen is really composed of two distinct slices of brickwork, each $4\frac{1}{2}$ inches thick, and having no connection with one another, except that afforded by the mortar.

To avoid this defect, the bricks or stones forming a wall are not all laid in the same direction as in Fig. 1, but some are laid parallel to the length of the wall, and others at right angles to them, so that the length of one of the latter overlaps the width of two below it.

¹ Sc. Band.

*Headers*¹ are bricks or stones whose lengths lie across the thickness of the wall, the ends (or "heads") of those in thin walls, or in the outside of thick walls, being visible on the face.

*Stretchers*¹ are bricks or stones which lie parallel to the length of the wall, those in the exterior of the work showing one side in the face of the wall.

It is most important that the construction of a wall should be uniform throughout, or that care should be taken, by using quick-setting cement, to prevent the unequal settlement that will otherwise take place. The evils caused by neglecting these precautions will be more fully entered upon in the Advanced Course, Part II.

The bricks or stones used for walling or arches should be well wetted before use, not only to remove the dust which would prevent the mortar from adhering, but also to prevent the bricks or stones from absorbing the moisture from the mortar too quickly.

In building upon old or dry work, the upper surface should be swept clean and wetted before the mortar is spread upon it to form the bed for the new work.

Brick or stone masonry should never be carried on while frost exists, or when it is likely to occur before the mortar is set.

If it is necessary to go on with the work at such a time, it must be covered up with straw or boards every night.

ARCHES.

An arch is an arrangement of blocks supported by their mutual pressure on each other (caused by their own weights), and also by the pressure of the outer blocks on the solid bodies from which the arch springs.

The blocks may be of stone or brick, cut to wedge shapes, so that their sides radiate from the centre, except in rough work, when the sides may be left parallel.

The following technical terms are used in connection with arches :—

¹ Some consider these names as peculiar to brickwork ; they are often used, however, in masonry, for stones placed as described. Sc. for "Header" and "Stretcher" in masonry is *Inbond* and *Outbond*.

Names of Parts.—The *intrados* or *soffit* is the under surface of the arch.

The *extrados* or *back* is the outer surface.

The *springing* is the points on each side from which the arch rises or “springs.”

The *springing line* is the line from which the arch springs—that is, the intersection of the arch with the body that supports it.

The *crown* is the highest point of the arch.

The *haunches* are the sides of the arch from the springing about half-way up towards the crown.

The *spandrels* are the spaces between the extrados, a horizontal line drawn through the crown, and a vertical line through the upper end of the skewback.

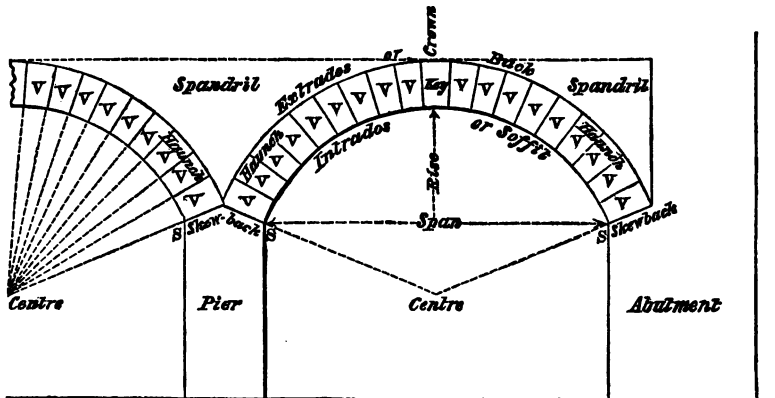

Fig. 2.

Abutments are the bodies supporting the arch, and from which it springs.

This term is, however, technically applied rather to the outer support of the last of a range of arches, to distinguish it from the intermediate supports or “piers.”

Piers are supports from two or more sides of which arches spring.

Jambs are the sides of piers or abutments.

Voussoirs (v v v, Fig. 2) are the blocks forming the arch, and supported by their mutual pressures.

The *key* is the centre voussoir at the crown.

Skewbacks are the upper surfaces of the abutments or piers from which an arch springs, and are so formed as to radiate from the centre.

The *span* is the horizontal distance from springing to springing spanned by the arch.

The *rise* is the height from the line joining the springings to the soffit at the crown.

The *length* is that of the springing line.

Ring courses are those parallel to the face of the arch.

String courses are those at right angles to the face and in the direction of the length.

Heading joints are those between the stones of the ring courses.

Coursing joints are those between the stones of the string courses.

Different forms of Arch.—A *Semicircular* or *Semi-arch* is one of which the soffit line is a semicircle.

A *Segmental arch* has an arc less than a semicircle for the curve of the soffit. It is sometimes called a *Scheme arch*.

An *Elliptic arch* has a semi-ellipse for the curve. Such an arch is necessary where there is a wide span, and but little height allowable.

A *Parabolic arch* has a parabolic soffit, and is used when vertical space greater than the span is required within the arch.

Gothic arches are made up of two or more curves, of which two intersect so as to form a pointed crown or apex.

Groined arches are those that intersect one another.

The four descriptions of arches last mentioned do not come within the limits of this course.

A *Straight arch* is shown in Fig. 3. The voussoirs radiate towards the centre *c*, found by describing an equilateral triangle upon *a b*.

This arch, though apparently flat on the soffit, is not really so, being built with a slight "camber," or rise of about $\frac{1}{8}$ or $\frac{1}{4}$ inch to every foot of span. The extrados of the arch is sometimes given about half the camber of the soffit, in order to prevent it from being hollow when the arch settles.

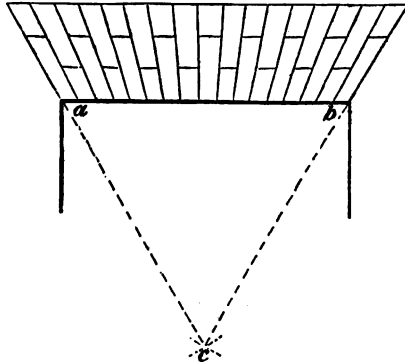

Fig. 3.

Camber arch is a name sometimes applied to the arch just described, or sometimes to arches with a slightly greater rise, such as 1 inch per foot of span.

Discharging arches,¹ *Jack arches*, *Relieving arches*, are those which are turned over lintels, so as to protect them from the weight of the wall above. See Figs. 88, 127, 313, and others.

Inverted Arches are like ordinary arches, but are built with the crown downwards. They are generally semicircular or segmental in section, and are used chiefly in connection with foundations, under which head they will be further considered in Part III.

PARTS OF WALLS.

Footings² are projecting courses formed at the bottom of a wall, so as to distribute its weight over a larger area. They will be more particularly described in connection with foundations (Part III.)

Quoins are the external angles or corners of buildings. The name is also applied to the blocks (of stone or bricks) with which those angles are formed. They should, if possible, be built more strongly than the rest of the walling, and are frequently so worked as to be more conspicuous.

External angles of buildings which are greater or less than right angles are termed *Squint Quoins*.

A Coping³ is a course placed upon the top of a wall to prevent wet from entering and soaking into the masonry.

It should, therefore, be of an impervious material, containing as few joints as possible, and should be set in hydraulic mortar or cement.

The upper surface should be "weathered,"⁴ or sloped so as to throw off the rain.

The coping should project a little over the wall on both sides; and should be "throated,"⁴ so that the wet may fall clear of the wall.

Brick and stone copings differ considerably in their construction, the details of which will be entered upon in Chaps. II. III.

A Cornice is a large moulded or ornamental course at the top of a wall, and is of the nature of a coping. The name is applied rather to the upper member of a principal wall in a building; whereas a coping generally surmounts a detached or less important wall.

¹ Sc. *Saving Arches*. ² Sc. *Scarcements*. ³ Sc. *Cope*. ⁴ See note, p. 50.

Fig. 4 shows a cornice at C, and more detailed examples will be found in Figs. 106, 131, 270, and others.

A **Blocking Course** is a course of stone placed on the top of a cornice to add to its appearance, and, by its weight, to steady the cornice, and prevent its tendency to overbalance.

The blocking course in Fig. 4 is marked B; and sections of a similar blocking course will be found in Figs. 231, 270, etc.

The name is also sometimes applied to a thick string course.

A **Parapet Wall** is a low wall running along the edge of a roof gutter or high terrace, to prevent people from falling over. See Figs. 227, 265, etc.

A **Balustrade** is a similar construction, but lightened by being broken into balusters, as shown in Fig. 132, p. 55.

An **Eaves Course** is a projecting course formed under the lower edges of the slopes of a roof (the *eaves*), either merely for ornament, or to support a gutter.

This, and any other course that projects over the wall, is called a *sailing course*, and should be throated to keep the wet off the wall below.

The **Plinth**¹ is a projecting base to a wall, intended to give an appearance of stability, and thus form an ornament.

The kind of plinth varies greatly, according to the style of the building—from a plain offset in the thickness of the wall, to a most elaborate and highly ornamental base.

In common buildings, with low walls, the plinth is generally omitted.

The plinth should project boldly, and the upper surface of the projection should be formed so as to throw off the rain.

The plinth in Fig. 4 is marked P; see also Fig. 110.

The **String Course** is a horizontal course, generally of stone, carried round a building, chiefly for ornament. If, however, the stones are well connected together, it forms a strong band round the walling, and is a source of strength.

The sills or lintels of windows are frequently continued throughout the length of the building, so as to form a "*Sill course* or *Lintel course*."

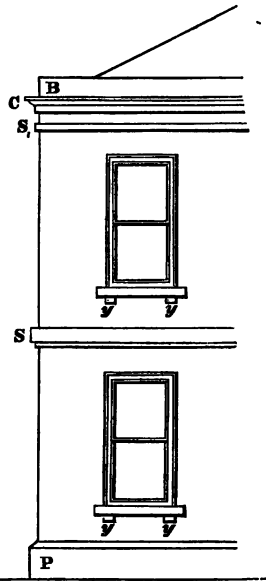

Fig. 4.

¹ Sc. Intake.

The string courses in Fig. 4 are marked S and S₁; the latter may, in some cases, form part of the cornice, and is then called a *Necking*.

Corbelling.—In many cases it is necessary to project certain courses of a wall beyond the face, in order to support wall plates, (Figs. 107, 201), for ornament in cornices (Fig. 106), to gain increased base for a chimney or wall above (as in Fig. 269), or in “gathering¹ over,” or reducing an opening where an arch cannot easily be turned.

This is done by corbelling or projecting each course beyond the one last laid. If the weight to be carried is very great, the portion corbelled out will be proportionately deep, and the projection of each brick or stone should never be so great as to prevent its back joint from being kept well within the course below.

APERTURES IN WALLS.

The apertures required in walls are chiefly those for doors and windows.

Heads.—Each opening is generally closed at the top, either by an arch, as shown in Figs. 83, 87, 306, 322, etc., or by a “lintel” of stone, as in Figs. 127, 312, 313, 319.

In many cases the head is of an ornamental character, weak in itself, and requires to be protected from undue pressure by a relieving arch, as described at page 52.

Jamb.—These are the sides of the openings, and may either be square, or formed with recesses to receive the frame for the door or window.

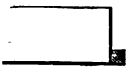

Fig. 5.

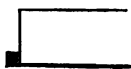

Fig. 6.

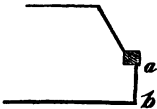
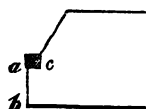

Fig. 7.



Reveals² are the portions of the sides of the openings left in front of the recesses for the frames (*a b* in Fig. 7). They are probably so called because they are revealed, or exposed to view, whereas the rest of the sides of the opening is generally hidden—the recesses by the frame which

fits into them, and the remainder by linings.

¹ Sc. for “gatherings”—*Incomes* or *Oncomes*.

² The term reveal is somewhat loosely used, and is often applied to the width *a c* required for the frame.

The jambs behind the reveals may either be *square*, as in Fig. 6, or *splayed*, as in Fig. 7. Openings with splayed jambs weaken the wall more than when the jambs are square. They are, however, convenient in order to afford room for shutters, etc.

The thickness of the reveal is generally from $4\frac{1}{2}$ to 9 inches in brickwork, or from 6 to 12 inches in stone, but varies according to circumstances.

Sills.¹—The lower side of the opening is generally furnished, both in brick and stone walls, with a sill of stone in one piece, and about 5 or 6 inches longer than the opening. This forms the base of the window, and supports the oak sill of the sash frame.

WINDOW SILLS should be set so as to bear only on the ends, the intermediate portion being left quite clear, with a hollow space underneath, as the weight of the piers of the window will probably cause a greater settlement in the wall under the ends of the sill than under the centre, in which case the sill would be pressed upwards in the middle, and broken.

Sills should project at least 2 inches over the face of the work and be throated so that they may keep the wet off the wall below them.

Different ways of finishing the ends of sills are shown in Figs. 311, 312, 316, 317, 319.

DOOR SILLS are also of stone, in a single piece, except for internal doorways, where they may be of oak.

Holes are sunk in these sills to receive the studs at the foot of the door frame.

The sill of an external doorway is generally formed by a stone step (see Fig. 306).

WOOD BUILT INTO WALLS.

Timber should be kept out of walls as much as possible. The evils produced by building in large pieces of timber will be pointed out in Part II. It is, however, frequently necessary to introduce pieces of wood in walling for different purposes, in which case they should be as small as practicable.

When the ends of timbers, such as girders, joints, tie-beams, etc., have necessarily to be built into walls, they should rest in chambers prepared for them, so that there may be a free circulation of air round the timber.

¹ *Sc. Sole.*

Wall Plates¹ are described at p. 88. They are sometimes built into the wall, but are there liable to the same objection, in a lesser degree, as bond timbers (see Part II.)

TEMPLATES are short wall plates intended to support particular beams,—frequently they are of stone or iron.

Wood Lintels are beams over openings, such as those for doors or windows, shown in Figs. 88, 322, etc.; they should never be used without a relieving arch as shown in those figures (see p. 31), and they may be replaced by flat arches, as in Figs. 307, 317, etc., or by cement concrete beams made with ashes or breeze from gasworks, so as to admit of the woodwork being nailed to them. (See Fig. 317.)

The arches and concrete have an advantage over wood lintels, inasmuch as they are not liable to destruction by fire or decay.

Rule.—Thickness of lintel in inches should be equal to span in feet; that is, thickness of lintel = $\frac{1}{12}$ span, or some take it = $\frac{1}{8}$ span. The ends of the lintel should bear 9 inches on the walls, but $4\frac{1}{2}$ inches' bearing is often considered sufficient.

Bressummers are beams, either of wood or iron, spanning wide openings, and generally supporting a wall above.

Wood Bricks² are pieces of timber built into brick walls, in order that the necessary woodwork of the building may be secured to them.

They should be of the shape of the bricks in use, and equal in thickness to a brick and two mortar joints, so that the rough surfaces of the adjacent bricks may have a firm grip on the wood. If wood bricks are imbedded in mortar they are nearly sure to become loose.

Several examples in which wood bricks are used are shown throughout these notes. Fig. 85 gives the arrangement of the wood bricks for securing a door or window frame.

PALLETS or **WOOD SLIPS** are flat pieces of wood, about 9 inches long, 3 inches wide, and $\frac{3}{8}$ inch thick. They are built into the joints of brickwork or masonry, to fulfil the same object as wood bricks, and have to a great extent superseded them, as they shrink less, and do not leave such a gap in the wall if they decay or are burnt out.

Wood Plugs are used in masonry, and sometimes in brickwork, for the same purpose as wood bricks. When anything is to be nailed to a wall, a plug should be driven in first, as the nail will not hold in the masonry.

¹ Ir. *Tassels*.

² Sc. *Dooks*.

Plugs should be about 4 to 6 inches long, $1\frac{1}{2}$ or 2 inches wide, and about $\frac{1}{2}$ inch thick, and in order to give them a better hold on the masonry they are cut with a twist, so that the grain of the wood runs obliquely across their thickness, and their sides are not parallel but splayed and in winding.

Great injury is often done to walls by driving wood plugs into the joints, as they are apt to shake the work, especially if it has been recently built. It is better to cut holes for the plugs in the solid stone or bricks.

Examples of plugging are given in Fig. 316, and others.

Tubular Bricks with Wood Plugs.—To avoid driving plugs into masonry, tubular bricks are sometimes built in the required positions, with plugs driven into the hollow spaces in their interiors. *Pallette Bricks*, which have a rebate of dovetail-shaped section formed along the upper outer edge to hold a fillet, are also used.

Substitutes for Wood Bricks.—If it is desired to dispense altogether with wood in the walling, small double strips of hoop iron may be placed in the joints at every point where a nail is to be driven. These firmly grip the nail, which is driven in between them. Strips of lead may be used for the same purpose.

Concrete Bricks, made of 4 parts breeze from gasworks and 1 part Portland cement, a material which will allow nails to be driven into it, have also been suggested as a substitute for wood bricks.¹

¹ Seddon's *Notes on the Building Trades and Building Construction*.

CHAPTER II.

BRICKWORK.

GENERAL REMARKS ON BRICKWORK.

IN order to obtain good brickwork the following points should be attended to.

The bricks must be sound and well shaped. (See Part III.)

The mortar should be of good quality (see Part III.), carefully mixed, and used stiff.

A good bond should be preserved throughout the work, both laterally and transversely. All bed joints should be perpendicular to the pressure upon them; that is, horizontal in vertical walls, radial in arches, and at right angles to the slope of battering walls.¹

In walling, the courses must be kept perfectly horizontal, and the arrises plumb. The vertical joints should be directly over one another,—this is technically called “keeping the perpends,”—if it is neglected the courses are overrun and “bats” become necessary.

The joints should all be full of mortar, close, well flushed up, and neatly struck or pointed as required.

In good brickwork they should not exceed $\frac{3}{8}$ inch in thickness, but with badly-shaped rough bricks the beds of mortar are necessarily made thicker, in order to prevent the irregularities of the bricks from bearing upon one another, and causing fracture.

Both bricks and mortar-joints should be of uniform size and quality in all parts of the work.

Size of Bricks.—As stated in the chapter on materials (Part III.) bricks are made of different sizes; but by far the most common in England are those about 9 inches long, $4\frac{1}{2}$ inches wide, and $2\frac{1}{2}$ inches thick, which alone will here be treated upon.

Bricks of other dimensions are laid on the same principles.

“In nearly all cases bricks built in walling are laid upon their sides, occupying 9 inches \times $4\frac{1}{2}$ inches on plan.

Thickness of Wall.—The thickness of a wall is the distance

¹ A “battering” wall is one which is not vertical, but built with an inclination or “batter.”

from the face to back, and is expressed in terms of a brick, thus :—a half-brick wall is $4\frac{1}{2}$ inches thick ; a one-brick wall is 9 inches thick ; a brick and a half wall is $13\frac{1}{2}$ inches (generally called 14 inches) thick, and so on.

A *course* is a horizontal slice of the wall taken between two bed joints, and is of a depth equal to that of a brick and one mortar joint.

A "*bat*" is a broken brick, and is called a $\frac{3}{4}$ bat, $\frac{1}{2}$ bat, etc., according to the proportion it bears to a whole brick.

Headers are bricks whose lengths lie across the thickness of the wall. Those visible on the outside of the wall show an end in the face or back.

Stretchers are the bricks which lie parallel to the length of the wall. Those visible on the exterior show one side in the face or back of the wall.

Heading courses are those showing no bricks but headers in the face.

Stretching courses are those containing in the face stretchers only.

Bond.—The meaning of this term, and the general characteristics of a good bond, have been described at p. 2.

It was there shown that a wall may appear on the face to be well bonded, when in fact there is no bond at all between its front and back.

Fig. 8 shows a wall composed of courses of headers and stretchers alternately. By this arrangement thorough bond is obtained across the thickness of the wall, as each header overlaps two stretchers ; but it will be seen that, as the length of each brick is exactly twice its width, every alternate vertical joint coincides throughout the whole depth of the wall, which is thus divided into several independent vertical strips or piers, having no bond or connection with one another.

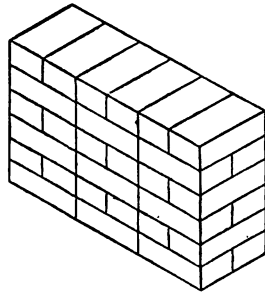

Fig. 8.

This is manifestly a weak and defective arrangement. The remedy for the evil is the use of "closers."

CLOSERS are pieces of brick inserted in alternate courses, in order to prevent two headers from being exactly over each stretcher, and thus to obtain a *lap*.

Queen closers are bricks cut longitudinally in half, or spe-

cially made of the size and shape of half a brick. They are inserted next to the last bricks at the angles of the wall, in alternate courses, as at *c c c*, Fig. 9, and being each only half the width of a brick, have the effect of causing every brick in these courses to be placed $2\frac{1}{4}$ inches farther from the corner than it is in Fig. 8. The bricks of the intermediate courses remain in the position

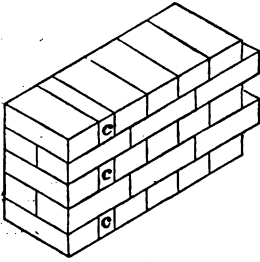

Fig. 9.

shown in that figure, and the consequence is that the vertical joints of the courses containing closers, instead of coinciding with those of the courses above and below, are $2\frac{1}{4}$ inches beyond them in every case, and thus *straight* vertical joints are avoided.

Closers should, if possible, be arranged so as to extend right through the thickness of the wall.

As it is not easy to cut a brick longitudinally in half without breaking it, it is frequently cut into quarters, each of which is a half closer, and two placed end to end form a queen closer.

King closers are bricks cut to this shape, the face of the wall, they present the same as an ordinary $\frac{1}{4}$ brick closer; but the tail being left on, strengthens the work considerably, and is a great advantage in some situations, such, for example, as that shown in Fig. 94 (see p. 32).



Fig. 10.

so that, in appearance of the brick, and is

Three-quarter bats are sometimes used instead of closers.

If so, they should be placed at the extreme end of the wall, so as to form the quoin bricks of the stretching courses, as at *b b b* in Fig. 11.

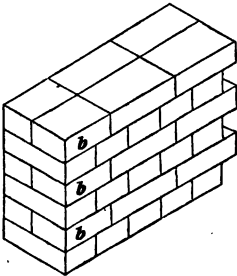

Fig. 11.

They may, however, be used in the same position in the heading courses, and for all thicknesses of walls. The use of $\frac{3}{4}$ headers is expensive and wasteful, for each of them spoils a whole brick, the piece cut off being useless; whereas, with ordinary closers, every bit of brick may be used up.

DIFFERENT BONDS.

Heading Bond consists entirely of headers. As bricks vary in length more than in any other dimension, their ends project unequally on the face, and it is difficult, therefore, to make neat work with this bond, especially in walls one brick in thickness.

There is very little longitudinal strength in the wall, and the pressure on each brick is distributed over a comparatively small area (see Fig. 12).

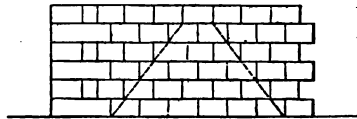

Fig. 12.

Heading bond is chiefly useful in working round sharp curves, where the angles of stretchers would, unless cut off, project too much, and spoil the curve. When used in this position, the sides of the bricks must be roughly cut, so as to radiate from the centre of the curve.

In walls of heading bond more than one brick thick, a line of bats or half-bricks must be introduced, in alternate courses, to form the transverse bond.

Stretching Bond consists entirely of stretchers, and is adapted only for walls $\frac{1}{2}$ brick thick.

In walls beyond that thickness (see Fig. 1) it is practically no bond at all. There is no transverse tie. The block is divided into a number of independent $4\frac{1}{2}$ -inch walls.

Stretching bond is, however, commonly used in chimneys when their external walls are only $4\frac{1}{2}$ inches thick, and has, in consequence, received the name of "*chimney bond*."

English Bond shows both on face and back, stretching and heading courses alternately, closers being inserted as shown, and as before described, to give the lap (see Fig. 13).

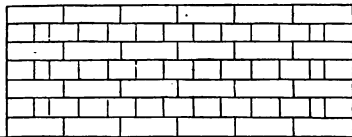

Fig. 13.

This is the best bond for work generally. It gives the most simple combination for longitudinal and transverse strength.

Figs. 14, 15, 16, give plans of the courses, and a section of a wall in English bond one brick thick; and Figs. 17, 18, 19 afford the same information for a wall $1\frac{1}{2}$ brick thick.

In the last-mentioned wall each course contains a row of headers

and one of stretchers, the headers and stretchers appearing alternately on opposite sides of the wall.

This latter will be found to be the case in every wall whose thickness is an *uneven* number of *half-bricks*. In such, every course showing stretchers on the face will show headers at the back, and *vice versa*. See Figs. 24, 25, and others.

In a wall whose thickness is a multiple of a *whole* brick, that is, of 9 inches, every course will show the same both on the front and back of the wall—that is, either stretchers on both sides, or headers on both sides, in the same course.

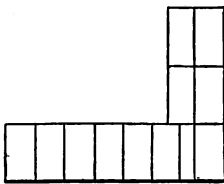
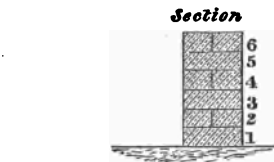

Plan of Courses 2.4.6.

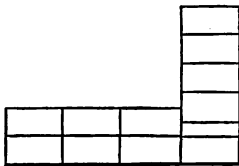

Plan of Courses 1.3.5.

Figs. 14, 15, 16.

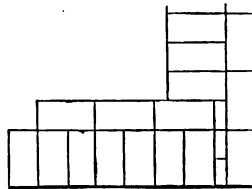
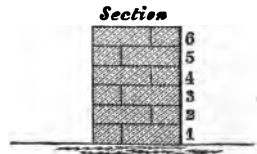

Plan of Courses 2.4.6

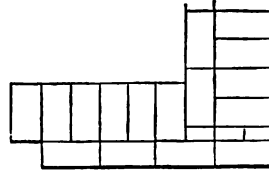

Plan of Courses 1.3.5

Figs. 17, 18, 19.

In walls more than 14 inches thick, though the external rows of bricks are headers or stretchers in the alternate courses, yet those within the wall are all laid as headers. Stretchers within the wall would cause straight joints.

The bricks should not break joint with each other in the same course. The transverse joints should be straight, as shown.¹ Any attempt to break these joints, though it may look better in the plan of each course, leads to a large number of vertical

¹ See p. 19.

joints being brought together in the body of the work (see pp. 19 and 25).

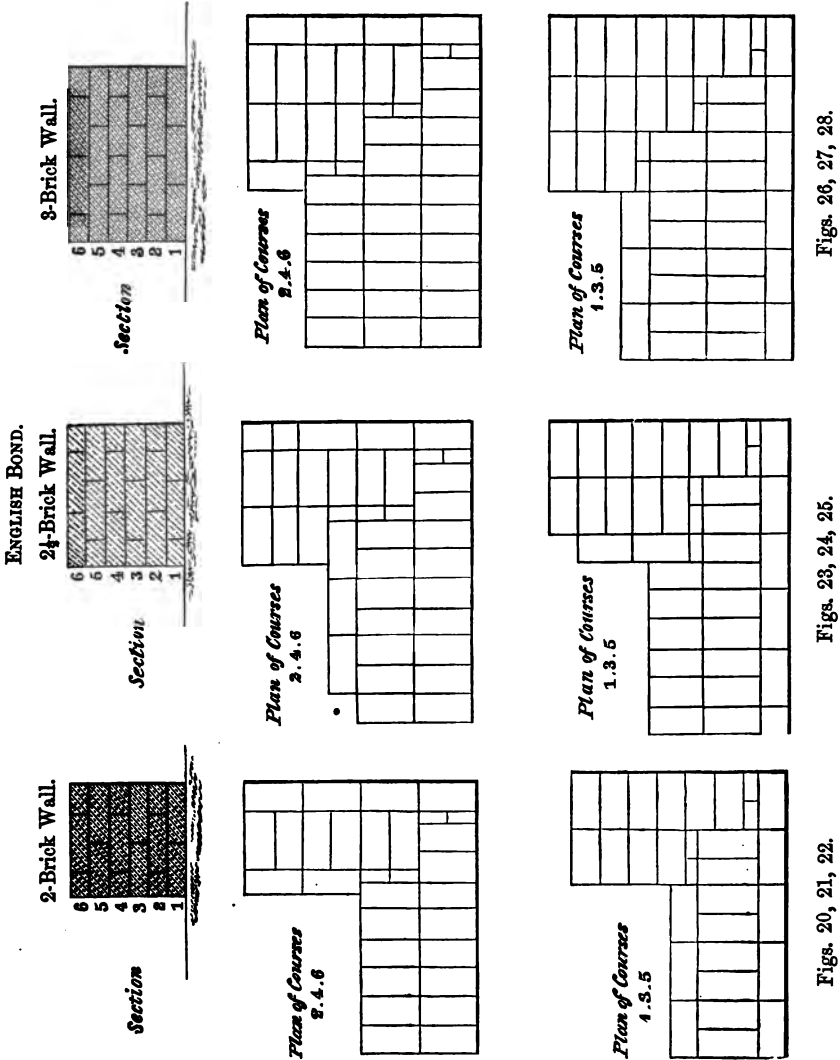

Figs. 26, 27, 28.

Figs. 23, 24, 25.

Figs. 20, 21, 22.

Figs. 20 to 28 give plans of the courses, showing the junction at angles, and sections of walls from 2 to 3 bricks thick.

It will be seen that in walls more than 14 inches thick there is a deficiency of stretchers in the centre of the wall. This can best be remedied by introducing courses of bricks placed diagonally, the bond for which will be explained in Part II.

The number of stretchers is less in proportion as the wall grows thicker, being as follows:—

In a $1\frac{1}{2}$	brick wall	the stretchers	are $\frac{1}{2}$	number of the headers.
" 2	"	"	"	"
" $2\frac{1}{2}$	"	"	"	"
" 3	"	"	"	"

In English bond there are twice as many vertical joints in a heading course as there are in a stretching course; therefore the vertical joints between the headers must be made thinner than those between the stretchers; for if two headers were laid so as to occupy a greater length than one stretcher, the $\frac{1}{4}$ -brick lap obtained by the aid of the closer would be encroached upon, and would soon disappear.

The figures given above show the bond used for walls meeting at the ends to form a right angle, which is the most common case in practice.

If, however, a wall is detached and terminated only by its

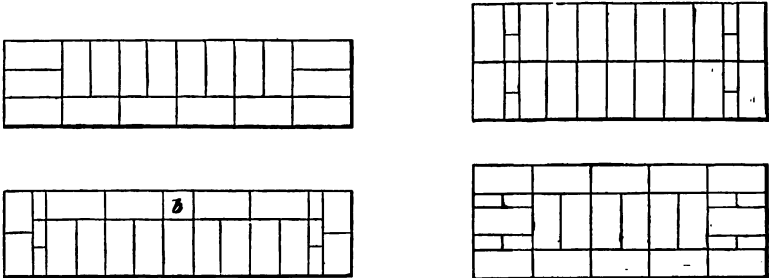

Figs. 29, 30.

Figs. 31, 32.

ends being cut off square, as shown in Figs. 29 to 32, the bond has to be slightly modified, so as to give the ends a neat finish.

In such walls, when they are of an uneven number of half-bricks in thickness, a peculiarity must be noticed—both sides do not present the same appearance. The closers show both in the stretching and heading courses alternately; but in those sides of stretching courses in which the closers appear, a bat has to be introduced to keep the bond; this side should be the back of the wall.

Fig. 30 shows an example of this; the bat referred to being at *b*.

Figs. 31, 32 give plans of two courses of an 18-inch wall, with returned ends. Want of space forbids any further illustration of

such walls ; but the student should draw them for himself, bearing in mind what is stated above, and remembering also that the returned ends of thick walls should be treated so as to show a bond similar to that on the faces of the walls.

ENGLISH BOND WITH BROKEN TRANSVERSE JOINTS.—It has been said above (see p. 17) that the joints across the thickness of walls should be unbroken. This has, however, been objected to on the ground that in bad work—the vertical joints of which are not flushed up, and the face not properly pointed—the rain may be blown through these half-empty straight transverse joints, so as to make the wall damp on the inside. A bond with broken transverse joints is therefore often advocated and adopted, but it has serious defects, which will now be pointed out:—

Figs. 33, 34 show two courses of a 14-inch wall, and Figs. 35, 36 the same of an 18-inch wall with broken transverse joints. Fig. 37 is a plan of the two courses (A and B) of the 18-inch wall, one laid upon the other, A being shown in dotted lines, and B in thin lines. The thick lines, marked *y*, show portions of the joints which coincide and fall into the same vertical plane.

It will be seen, therefore, that the wall contains splits (marked *y*) $4\frac{1}{2}$ inches wide, extending from top to bottom of its height, and occurring at intervals of $4\frac{1}{2}$ inches throughout its length.

These are a source of weakness, and may be avoided by adopting the simple plan recommended at p. 17, and shown in Figs. 21, 22—that is, by making the transverse joints run straight from face to back of the wall.

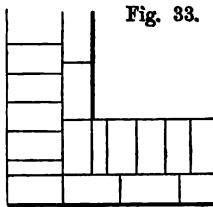

Fig. 33.

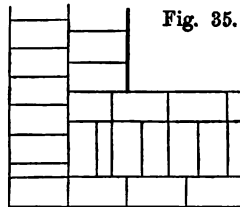

Fig. 35.

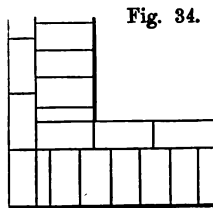

Fig. 34.

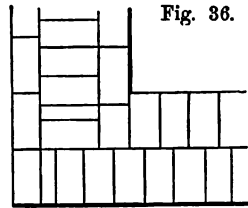

Fig. 36.

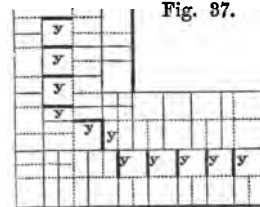

Fig. 37.

When two courses of a wall so bonded are drawn in position, one over the other, as in Fig. 38, it will be seen that the vertical joints coincide only in one place for a length of 9 inches, as shown by the thick line.

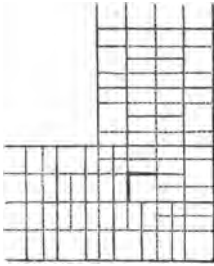

Fig. 38.

The bond of Figs. 33, 34, tested in the same way, will show similar defects to those described, and the same will be found in walls of all thicknesses where it is attempted to break the transverse joints. The student will be able to test any such examples for himself

by drawing two courses, one above the other, as above described. Thus, however good the workmanship may be, the use of broken transverse joints can result only in walls containing defects which must injure their strength, whereas with straight transverse joints the wall is properly bonded in almost every part (see Fig. 38); and if the work is properly flushed up and pointed, as it should be, there is no danger of rain finding its way through the wall.

Flemish Bond shows in elevation (either on one or both faces of the wall, according to the variety of the bond adopted), in every course, headers and stretchers alternately; every header is immediately over the centre of a stretcher in the course below it; closers are inserted in alternate courses next to the corner headers to give the lap.

The appearance of the face which distinguishes Flemish bond is shown in Fig. 39.

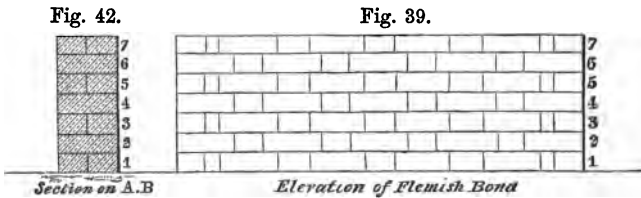

Fig. 42.

Fig. 39.

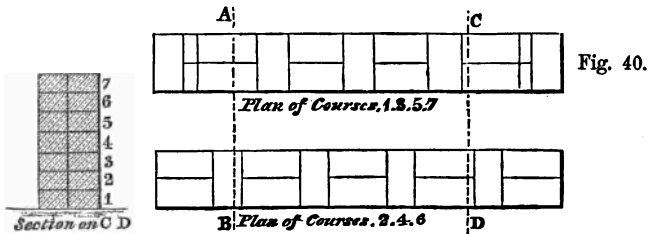

Fig. 40.

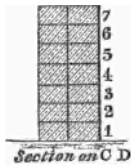

Fig. 43.

Fig. 41.

Figs. 40 to 43 give plans of two courses and sections taken at two points of a 9-inch wall in Flemish bond.

For thicker walls the back may either be in Flemish bond, like the front, or in English bond: this leads to two or three varieties of Flemish bond, which will now be described.

DOUBLE FLEMISH BOND implies that both the front and back of the wall are built in Flemish bond, presenting an elevation like Fig. 39 on both faces of the wall.

Figs. 44 to 49 give plans of two courses and sections taken at two points of a 14-inch and an 18-inch wall respectively in double Flemish bond. In each case two sections are given—one on A B, through the strongest, and the other on C D, through the weakest part of the wall.

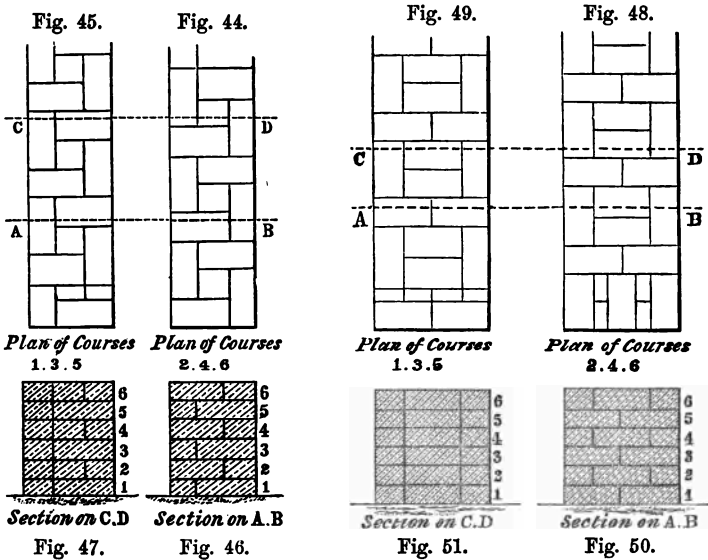

In these it will be seen that, at certain parts of the wall, straight joints occur throughout its whole depth, as shown by the section on C D in each case. Moreover, in all walls of an odd number of bricks in thickness, a large number of half-bricks have to be used in the centre.

The above are objections to this form of bond; and they are greatly aggravated by the usual method of doing the work, shown in Figs. 52 to 59.

Double Flemish Bond with False Headers.—Figs. 52 to 55 show plans of two courses, and sections taken at two points of a

14-inch wall; and Figs. 56 to 59 give the same information for an 18-inch wall built in Double Flemish bond with false headers. In the 14-inch wall it will be noticed that the headers consist only of half-bricks, having no bond with the interior of the wall.

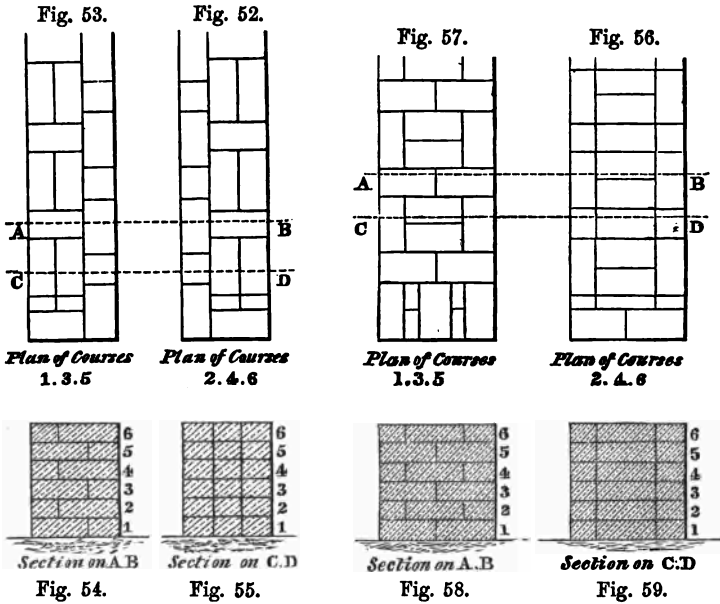

In the 18-inch wall only the headers in every alternate course are half-bricks. Thus, in the 14-inch wall all the headers, and in the 18-inch wall half the entire number of headers are false.

The effect of this is to cause a straight joint through the whole depth of the wall on both sides, as shown in the sections on C D in each case.

This arrangement is often adopted when the facing is of superior bricks, in order to economise them. The half-bricks look like headers, though they are useless for the bond.

SINGLE FLEMISH BOND consists of Flemish bond on one face of the wall, with English bond on the other.

This combination is made in order that the work may on the face look like Flemish bond, the appearance of which is, or was, supposed to be superior to that of English bond, and, at the same time, to get rid of the defects of Flemish bond in the interior of the wall.

Figs. 60 to 71 give plans of two courses and sections taken at

two points of walls of different thicknesses in single Flemish bond.

SINGLE FLEMISH BOND.

1½-Brick Wall.

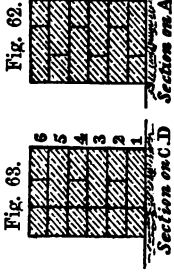

Fig. 60.

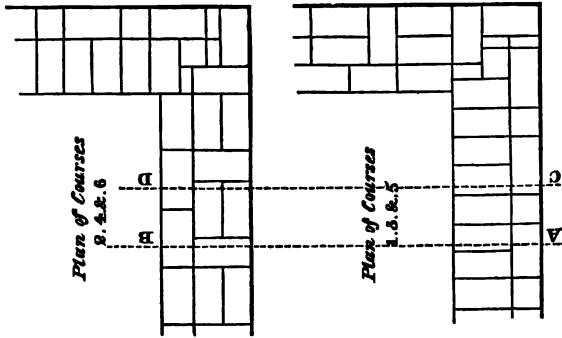

Fig. 61.

2-Brick Wall.

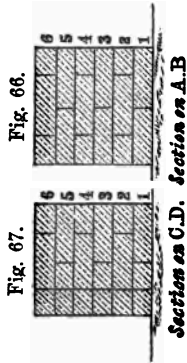

Fig. 64.

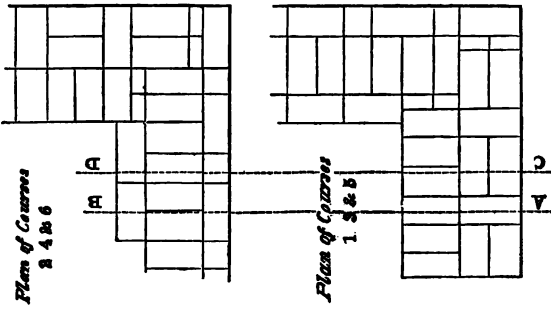

Fig. 65.

3-Brick Wall.

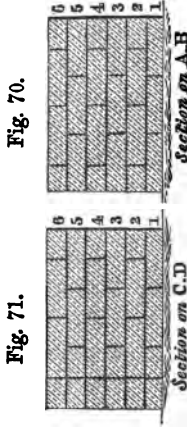

Fig. 68. Plan of Courses 2, 3, 4, 5, 6

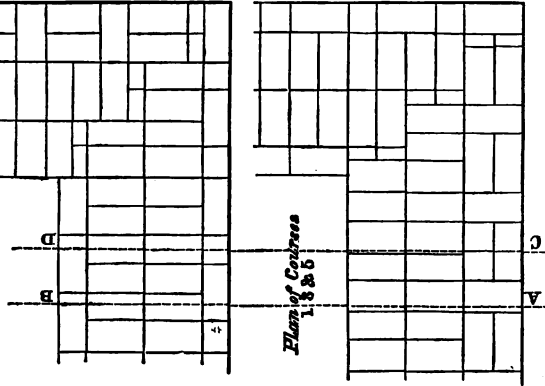

Fig. 69.

The sections on C D show that the straight vertical joint

which occurs on both sides in most cases of double Flemish bond, is now confined to the Flemish facing.

It will be noticed that false headers are used in alternate stretching courses throughout the Flemish facing. These can be avoided, as before explained; but they are more economical, and are therefore generally preferred, though their use leads to bad work in more ways than one (see Part II.)

In some cases a combination of the two methods is adopted. Some of the headers in every course are left entire—the intermediate ones being broken in two.

The consideration of the evils connected with the practice of facing walls with work superior to that in the backing forms a part of the Advanced Course, and is entered upon in Part II.

Comparison of English and Flemish Bond.—English bond is, upon the whole, to be preferred to Flemish bond for strength, as it contains a larger proportion of headers. The only advantage claimed for Flemish bond is its appearance, which is preferred by many, and has led to its use in brick buildings of a superior class.

In 9-inch walls a better face can be shown on both sides by Flemish than by English bond, as the unequal length of headers causes a rough face when there are many of them.

In walls of $1\frac{1}{2}$ brick in thickness the strength is not so much impaired by using Flemish bond, as it is in thicker walls.

For thick walls English bond should be used, if possible; but, if Flemish bond is required, it should have a backing of English bond, as described at p. 22, unless it is to show a fair face on both sides.

Some bonds not in very common use, such as diagonal, herring-bone, and garden bond, form a part of the Advanced Course, and are described in Part II.

Inferior forms of English Bond.—Figs. 72, 73, are plans of two courses of an 18-inch wall, showing the bond frequently recommended in books. It will be noticed that course A has broken transverse joints, but the advantages claimed for these (see p. 19) are neutralised by the straight transverse joints in course B; and upon further investigation it will be seen that the defects caused when all the transverse joints are broken are aggravated by this mixture of the two systems.

Fig. 74 is the plan of two courses (one laid upon the other)

of the 18-inch wall bonded as shown in Figs. 72, 73. The course A is uppermost, and shown in thin lines; course B below being drawn in dotted lines. Those portions of the joints which coincide in both courses are shown in thick lines.

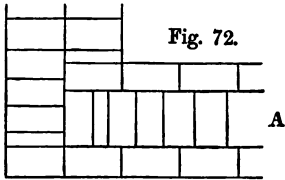

Fig. 72.

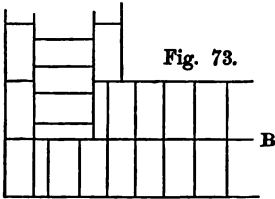

Fig. 73.

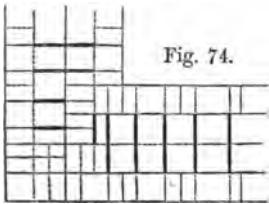
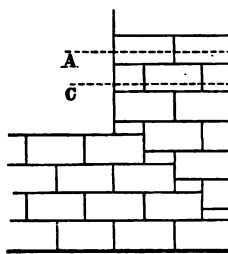

Fig. 74.

It will be seen, therefore, that the centre of the wall for more than half its thickness is split up by these coincident or "straight" joints, into vertical

Fig. 75.



Plan of Courses 1.3.5

Fig. 76.

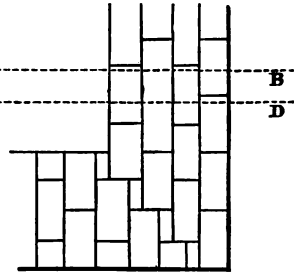

Plan of Courses 2.4.6

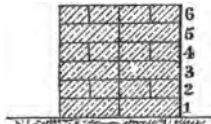

Section on A.B

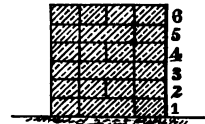

Section on C.D

Fig. 77.

Fig. 78.

slabs having no connection with one another except on the faces of the wall.

The bond shown in Figs. 75, 76 is frequently recommended for angles formed by walls of considerable thickness, but is also open to objection, although on paper each course presents a symmetrical appearance.

It will be seen by the sections that although each course is well bonded in itself, and appears to be of a strong construction, false headers are used, and there is no part of the wall which is not split up by one or more vertical joints extending throughout its whole height.

The merits of respective bonds and the defects of some forms frequently recommended, are fully discussed in Sir Charles Pasley's treatise on brickwork, from which much of the information given above is taken.

Sir Charles Pasley recommends that a student desirous of thoroughly understanding the various bonds, and of testing their respective merits, should build them for himself with model bricks; or if this cannot conveniently be done, he should at least draw the courses, one above another, as in Fig. 38, in order to ascertain whether any of the joints coincide so as to form splits in the wall.

JUNCTION OF WALLS AT RIGHT ANGLES.

Salient Angles.—Several examples of these are shown in Figs. 14 to 28, 60 to 69, and others.

Re-entering Angles.—*Junction of two Brick Walls.*—Figs. 79, 80, are the plans of two courses of the junction between a main wall $2\frac{1}{2}$ bricks thick, and a wall at right angles to it 2 bricks thick, both in English bond.

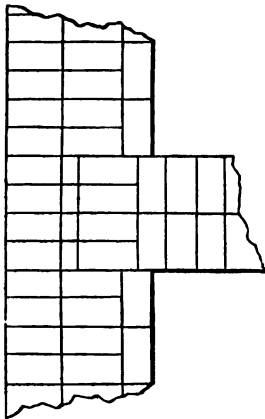

Fig. 80.

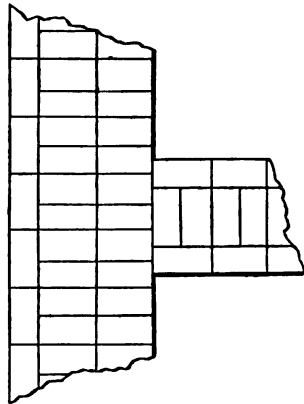

Fig. 79.

In every alternate course of the principal wall, exactly opposite the junction, is inserted a row of closers, in length equal to the thickness of the other wall (see Fig. 80).

The intermediate courses are built as usual in both walls, and merely butt against one another, without bond, as in Fig. 79:

A course of stretchers may, however, be inserted occasionally to improve the bond between the walls, although it leads to straight joints in the walls themselves.

Hoop-iron bond (see Part II.) may be used with advantage in such positions.

The bond for external or internal re-entering angles is shown in Figs. 14 to 28, and in Figs. 60 to 69.

Junction of a Brick and Stone Wall.—This may be effected in either of two ways:—

1. Stones at short vertical intervals, each equal in height to an exact number of courses of the brickwork, may be allowed to protrude from the stone wall into the brickwork.

2. The brickwork may penetrate the stonework in blocks, each of which consists of about 4 courses in depth, and is separated by about the same depth from the blocks above and below it.

The former plan is the strongest, and has the advantage of clearly showing the bond at any time; but the latter plan must be adopted if the brickwork is not to be plastered, so that it may not be disfigured by the stone bonds.

GAUGED WORK.

Bricks cut and rubbed to the exact shapes required, in order to get very fine joints, are frequently used in the “dressings” of brickwork, such as arches, quoins, etc.; this is termed “*gauged work.*”

Peculiar bricks, such as “red-rubbers,” “malm-cutters,” etc., are made for the purpose, being softer, and easier to rub, but they are consequently more perishable than ordinary good bricks.

Gauged work is generally set in putty, and the joints do not exceed $\frac{1}{10}$ to $\frac{1}{8}$ inch in thickness.

BRICK ARCHES.

Plain or Rough Brick Arches are those in which the bricks are not cut, or rubbed, so as to form voussoirs accurately radiating to a centre. The joints are therefore wider at the “extrados” than they are at the “intrados.” Such arches are used for ordinary brickwork in tunnels, and concealed work generally.

Rough arches of small span are generally turned in half-brick rings, $4\frac{1}{2}$ inches thick, as shown at *h h* in Fig. 81. In arches of quick curve, with not more than 3 or 4 feet radius, this is absolutely necessary to prevent very large joints at the extrados.

Fig. 81 is the section of portions of small arches, of which one,

$w w$, is turned in 9 inch rings consisting of headers. It will be seen that the mortar joints in this are much wider at the extrados than those of the portion $h h$, built in rings half a brick in thickness.

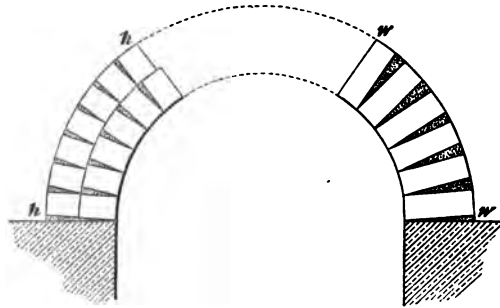

Fig. 81.

When wide joints necessarily occur on the extrados of an arch, they are often filled in with pieces of slate, and made as tight as practicable.

The plain or rough arches most usually required in buildings are those for relieving lintels over window and door openings (see Figs. 88, 313, 322), trimmer arches to support hearthstones (Fig. 204), the arches in chimney breasts (Part II.), etc.

Rough-cut or Axed Arches have the bricks roughly cut with a bricklayer's axe to a wedge form, and are used over openings when the work is to be plastered, as relieving arches at the back of window and door heads (see Figs. 307, 317), or as face arches in work of an inferior description.

Gauged Arches are built with bricks accurately cut, and rubbed down so as to radiate from the centre. They are used chiefly for external face arches over openings and recesses in superior work (see Figs. 87, 322).

Bricklayers frequently carefully rub only the portion of the joint near the face, cutting the back part right away, so that the arch does not bear equally, except just on the front edges of the bricks. This leads to the arch bulging forward, or to bricks dropping out of it altogether.

These arches are generally built with special bricks, easier to rub, and of a larger size than common bricks.

When bricks of the ordinary size are used, they are not long enough to be splayed at the ends to form the horizontal joints parallel to the soffit, as shown in Fig. 87. In such a case, the

ends of the bricks are left square, the real joints daubed over to conceal them, and false joints made for appearance to look like those in Fig. 87. This, however, is bad work, and should be avoided.

ARCHES OVER OPENINGS IN EXTERNAL WALLS.

In brickwork such openings are generally covered by a gauged (or sometimes axed) arch, which shows on the face of the wall for ornament, having a relieving arch on the inside to support the weight of the wall above (see Figs. 306, 322).

The external arch may be "flat," "camber," "segmental," "semicircular," or struck to any curve, such as the semi-ellipse or parabola.

If the external arch is semicircular, segmental, elliptical, or parabolic, the relieving arch is of the same curve, and so generally are the door and window frames.

Segmental Face Arch.—Figs. 82 to 86 give the plan, exterior

Fig. 83.

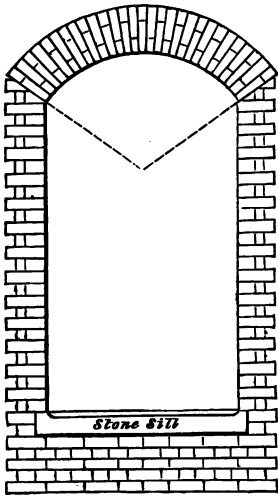

External Elevation

Fig. 85.

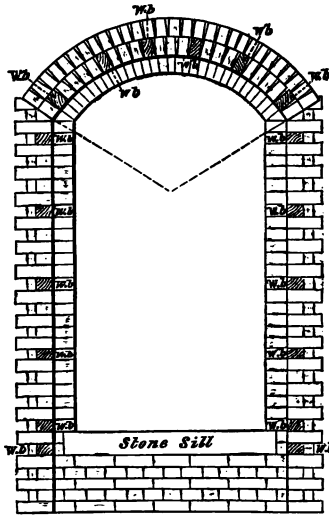

Internal Elevation

Fig. 86.

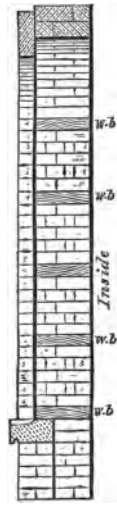

Section



Inside

Outside

Plan

Fig. 82.

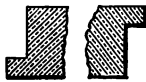

Outside

Inside

Plan

Fig. 84.



and interior elevations, and section, of a window opening with a segmental arched head.

It will be seen that the gauged arch extends into the wall only the depth of the reveal (in this case $4\frac{1}{2}$ inches). As this arch has no connection whatever with the rest of the wall, it should be built with the greatest care.

A rough brick arch in two half-brick rings is turned over the opening in the remainder of the thickness of the wall, and contains wooden bricks, *w b*, to which the sash frame may be secured.

Wood bricks, *w b*, are also built into the sides of the jambs, as shown, for the same purpose; but wood plugs or pallets (see p. 10) are frequently used instead.

Semicircular Arches are arranged in exactly the same way as those just described, the only difference being in the curve of the soffit.

Straight Arch.—If the head of the opening is to be flat on the

Fig. 87.

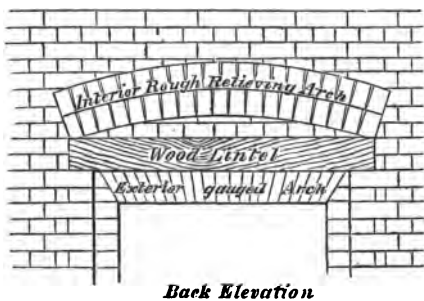
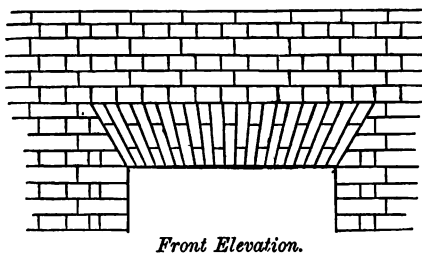

Fig. 88.

soffit, or nearly so, a straight gauged arch may be adopted, as shown in Fig. 87.

This gauged arch extends into the wall for a thickness of only half a brick. Behind it, the opening is spanned by a wood lintel, to which the frame of the door or window is fixed.

In order to protect the lintel from the weight of the wall above, a rough relieving arch is turned over it, as shown in the back elevation, Fig. 88. The portion between the top of the lintel and the soffit of the relieving arch is called the *core*.

Care must be taken that this relieving arch abuts on the wall clear of the ends of the lintel, otherwise, when the timber shrinks, rots, or is destroyed by fire, the arch would lose its supports and fall in.

Examples of wood lintels with relieving arches are given in Figs. 313, 322.

Another plan is to do away with the lintel altogether, and to substitute for it a flat or slightly cambered rough-axed arch like that in Fig. 90. In this wood plugs are inserted, to which the frame may be attached. An example of this form of construction is given in Figs. 306, 307, and others.

Arches of this kind for wide spans may be supported by flat wrought-iron tension bars, extending along the soffit, and held up at short intervals by iron bolts passing through the depth of the arch, each secured by a plate and nut on the extrados.

A concrete beam (see p. 10) may be used instead of the flat relieving arch described above (see Fig. 317).

French or Dutch Arches (see Fig. 89) are sometimes adopted

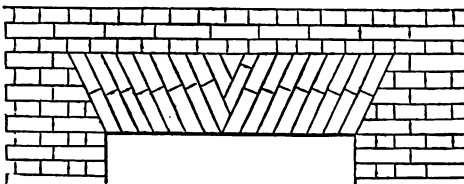

Fig. 89.

in walls that are to be stuccoed or plastered. They may also be used as flat relieving arches, but the construction is not theoretically a good one, and should never be adopted.

ARCHES OVER OPENINGS IN INTERNAL WALLS.

Arches over doors and other internal openings may be flat rough cut, or axed arches, containing wooden plugs, *ppp*, as

in Fig. 90; or a wood lintel may be placed over the opening, with a rough segmental relieving arch, similar to that in

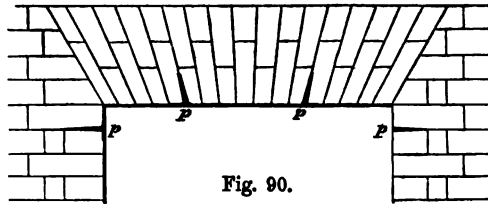

Fig. 90.

Fig. 88, the gauged arch shown in that figure being, of course, omitted. Of these constructions the last mentioned is commonly adopted. The use of rough-axed arches is however advocated on the ground that they do away with the wood lintel, which is liable to destruction by fire or decay, and to become loose by shrinking. Lintels of concrete, as described at page 10, may be used, and have the same advantages as flat arches.

JAMBS OF WINDOW AND DOOR OPENINGS.

The method of forming these openings, with or without reveals of different kinds, has been referred to at page 8.

The thickness of the reveal varies from $\frac{1}{2}$ a brick or $4\frac{1}{2}$ inches, to 9 inches or the length of a whole brick.

This thickness depends upon circumstances, but reveals a whole brick thick are generally used in important buildings.

Reveal with Square Jambs.—Such a reveal for a 2-brick wall in English bond is shown in Figs. 91, 92, which give plans of two courses, the thickness of the reveal being half a brick in each case.

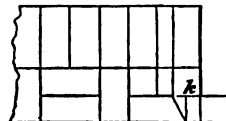
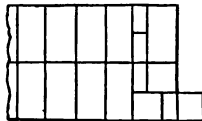
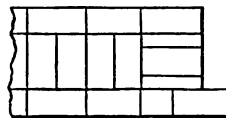
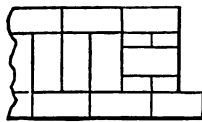

Figs. 91, 92.

Figs. 93, 94.

Figs. 93, 94 illustrate the arrangement for a similar reveal in Flemish bond. A king closer is inserted at *k*, to avoid using the small pieces shown in dotted lines.

Figs. 95, 96 show two courses of a 9-inch reveal with square jambs for a 3-brick wall in English bond.

Reveals are distinguished by the thickness of brickwork in front of the check left for the frame. Thus, a half-brick reveal means a reveal such as those in Figs. 91 to 94, having a thickness of half a brick in front of the angle into which the frame will fit; while Figs. 95, 96, in which this portion is 9 inches thick, represent a "whole brick reveal."

Of course, in walls more than one brick in thickness, the reveal may be either $4\frac{1}{2}$ inches or 9 inches in depth.

The reveals shown in Figs. 91 to 96 are adapted for cased frames or heavy solid frames requiring a width of $4\frac{1}{2}$ or 5 inches.

When lighter solid frames are used the width of the recess behind the reveal (*a c* Fig. 7), is often made only $\frac{1}{4}$ brick instead of $\frac{1}{2}$ brick, as shown in the figures.

It would be impossible, for want of space, to illustrate reveals of all the different dimensions, in walls of various thicknesses, but the examples given will assist the student in drawing any reveal required.

Reveals with Splayed Jambs are included in the Advanced Course, and will be described in Part II.

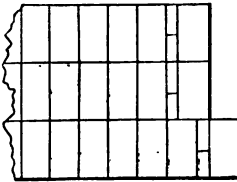
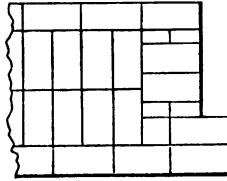

Figs. 95, 96.

PARTS OF BRICK WALLS.

Footings.¹—The general question of footings for walls will be considered in the chapter on Foundations, Part III. It will be

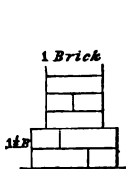

Fig. 97.

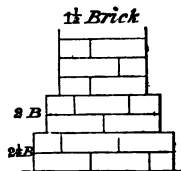

Fig. 98.

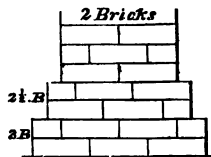

Fig. 99.

sufficient now to place before the student the figures 97 to 101

¹ *Sc. Scarcements.*

giving sections of footings for brick-walls from 1. to 3 bricks in thickness.

The plan of any particular course, whether "heading" or

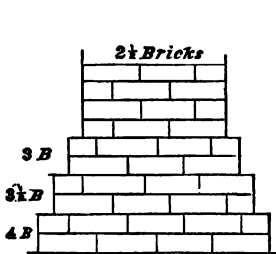

Fig. 100.

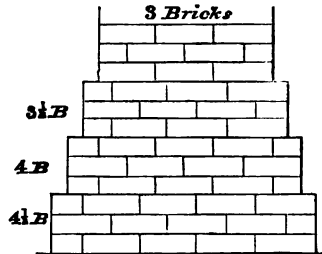

Fig. 101.

"stretching," is the same as that of a similar course in a wall of the same thickness.

For example, the plan of the lowest course in the footings of Fig. 99 is the same as that of the lowest course in the wall, three bricks thick, shown in Fig. 101.

Where the space available for the footings is shallow, and the superincumbent weight is not very great, the footings may be projected in single courses, as shown in Fig. 102, so as to gain the same width of bearing upon the foundation in a smaller depth. In such a case the outer bricks of the several single courses should be all headers, so that they may extend into the wall as far as possible.

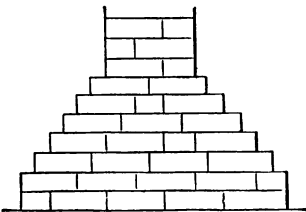

Fig. 102.

Footings composed of single courses are more common than those of double courses. The latter are to be preferred for strength, though they contain more brickwork, and are therefore more expensive. The lowest course of footings should always be a double one.

The footings of buildings generally rest upon concrete, which is not shown in the figures (see Foundations, Part III.)

Quoins in brickwork can hardly be made stronger than the rest of the walling: they should, however, be built with great care, and are often constructed in gauged work divided for appearance into blocks, which may be made to project slightly from the face of the wall. Stone quoins are often used with brick walls.

Copings.—The nature and object of copings for walls have been referred to at p. 6.

Stone copings are often used for brick walls, and are better than those formed with bricks, as they contain fewer joints, and may be of a less porous material.

Glazed pottery, fire-clay, and terra cotta copings may also be used with advantage, for the same reasons.

The hardest and least porous bricks should be selected for copings, and should be set or pointed in cement.

Fig. 103 is a section of the common "brick on edge" coping. A double course of tiles or slates, in either case called "*creasing*," is sometimes substituted for the projecting course of bricks, marked A. The brick on edge course on the top is called the *barge-course*.

Fig. 104 shows a brick coping of a more ornamental character.

Copings of gables are similar to those of independent walls, but do not, as a rule, project beyond the face.

Cornices (see p. 6) may be produced in brickwork with great effect by "*corbelling*" out the bricks without cutting them, and also by placing projecting bricks with their angles to the front of the wall, technically known as "*dogs'-teeth*."

A simple brick cornice is produced by allowing every alternate header to project from the face $\frac{1}{4}$ or $\frac{1}{2}$ a brick. Above and below these headers are courses of stretchers, projecting and receding $\frac{1}{4}$ brick respectively. Such a cornice is shown in Fig. 105, the moulded member on the top being a cast-iron eaves gutter.

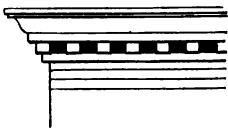

Fig. 105.

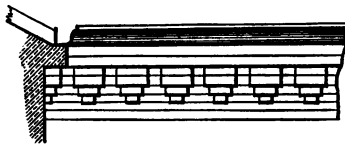

Fig. 106.

Fig. 106 gives an elevation and section of a more elaborate brick cornice.

Eaves Courses are formed by projecting bricks in a similar manner.

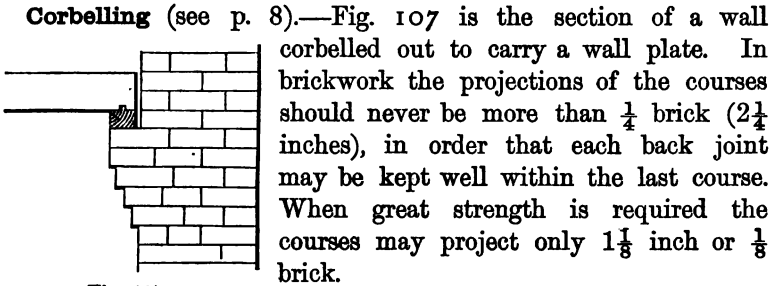

Fig. 107.

Stone corbels are often used in brickwork (see Fig. 20).

String Courses in brick walls are frequently of stone, but are sometimes formed with the bricks themselves, by projecting two or three courses to a distance of $\frac{1}{4}$ brick from the face of the wall.

CHAPTER III.
MASONRY.
WALLING.

Classification.—Masonry may be classed either as “ashlar” or “rubble.”

Ashlar is built from large blocks of stone, carefully worked, while *rubble* is composed of small stones, often irregular in shape, and in the roughest description, hardly worked at all.

Between these two there are many gradations.

Different kinds of masonry are sometimes combined. Thus, walls are built with ashlar facing and rubble backing, or even with stone facing and brick backing.

This leads to defective construction, the consideration of which forms part of the Advanced Course, and is entered upon in Part II.

General Remarks.—Masonry requires more skill to build than brickwork. The bricks, being all of the same size, are laid according to regular rules, whereas with each stone judgment is required, in order that it may be laid in the best way.

The higher the class of work the more regular are the stones, and the more easily are they built.

As a rule every stone in ordinary walls and arches should be laid upon its “*natural bed*,”—that is to say, the bed upon which it rested when in the quarry, should now be perpendicular to the principal pressure upon it.

When a stratified stone is placed vertically, and so that the layers of which it is composed are parallel to its face, they are apt to be split off in succession by the action of the weather. Moreover, a stone in this position has not so much strength to resist crushing as it has when placed on its natural bed.

In a cornice with overhanging or undercut mouldings the natural bed should be placed vertically and at right angles to the face, for if placed horizontally layers of the overhanging portions will be liable to drop off. There are other exceptions to the general rule which occur in more elaborate work; also some

dependent upon the nature of the stone, the quarry, etc. These will be noticed in Part III.

Great attention should be paid to the bond in all kinds of masonry. On the face the vertical joints should break upon every stone, no straight joints being allowed.

The bond across the thickness of the wall is of still greater importance, either "thorough bonds," extending from one face to the other, should be inserted at regular intervals, or "headers" should cross each other alternately from opposite sides, extending inwards about $\frac{2}{3}$ the thickness of the wall.¹

Some authorities prefer headers to thorough bonds in walls more than 3 feet thick, because the interior of the wall settles down rather more than the sides, leaving a hollow, so that a thorough bond stone would be unsupported in the middle, and might be broken. Another reason against long bond stones is, that there is danger of the beds not being evenly worked throughout, in which case the pressure comes upon a few points, and the stone is liable to break in two.

Masons are very apt to build up the sides of a wall separately, filling in with small stuff, or even dry packing. The wall thus consists of two thin slabs, united only by the thorough bonds.

This should never be allowed. The stones should be made to cross from opposite sides of the wall, and overlap as much as possible, so as to assist the bond stones in giving transverse strength to the wall. The interior of walls of every description should be solidly filled in, every stone being bedded in mortar, and all interstices flushed up.

Thorough bonds should always be amply thick enough to carry the weight above them, as, if broken, the fracture forms a dry joint, and they become worse than useless.

The width of bond stones may be about $1\frac{1}{2}$ times their height, and the aggregate surface shown by their ends, on each face of the wall, should be from $\frac{1}{8}$ to $\frac{1}{4}$ of the area of the face. Care should be taken that each bond stone is of sufficient sectional area throughout its length.

Thorough bonds present an advantage over three-quarter headers, inasmuch as they can always be traced in the work, and therefore cannot be omitted by the mason without detection, but they are more expensive, as each must be cut to a length exactly equal to the thickness of the wall, and, moreover, they are apt to conduct damp through the wall.

¹ Sometimes called *dog's-tooth bond*.

The practice of leaving the ends of thorough bonds striking out beyond the wall, and knocking them off afterwards, should not be allowed, as it shakes and injures the masonry.

Thorough bonds should not be placed directly over one another, but chequer-wise, so that each bond stone in any course is over the centre of the interval between two in the course below.

In work built up to courses the bond stones are generally specified to be from 4 to 5 feet apart in each course, and they should be placed in position before the course is built.

Large and sound stones should be selected for the quoins, jambs, etc., so that the angles may be well bound together, which materially strengthens the building.

Iron work should not be built into stone in positions where, by rusting, it might disfigure the face with stains, or in such a way that it may burst the stone, by its increase in bulk during oxidation, or by its expansion and contraction from heat and cold.

Ashlar Masonry is built with blocks of stone very carefully worked, so that the joints generally do not exceed $\frac{1}{8}$ or $\frac{1}{10}$ inch in thickness.

The size of the blocks varies with the nature of the stone, and must also be regulated according to the facilities that are available for moving and setting them.

Rule for the proportion of stones.—“In order that the stones may not be liable to be broken across, no stone of a soft material, such as the weaker kinds of sandstone, and granular limestone, should have a length greater than 3 times its depth. In harder materials, the length may be 4 or 5 times the depth. The breadth in soft material may range from $1\frac{1}{2}$ times to double the depth: in hard materials it may be 3 times the depth.—*Rankine.*”

Ashlar is the most expensive class of masonry built, and depends for its strength upon the size of the stones, the accuracy of the dressing, and the perfection of the bond; but hardly at all upon the quality of the mortar.

The mortar used for the superior descriptions of ashlar must be very fine, and free from grit. The outer portion of the joint, about $\frac{3}{4}$ inch in from the face, is generally filled with putty, as described at p. 41—either that formed from lime and water, and known as “plasterer’s putty,” or in some districts glazier’s white lead putty is used.

The faces of ashlar stones may be polished, worked in any way, or left rough; but a drafted margin¹ is generally run round them to ensure accuracy in setting and fitting the stones.

¹ “Drafted margins,” or “drafts,” are narrow strips or borders chiselled round the edges of the faces of a stone to enable it to be set with accuracy, and to improve its appearance.

The joints, though very carefully dressed, should not be too smooth, otherwise their surfaces will afford no key for the mortar, nor offer sufficient resistance to the sliding of the stones.

It is important, however, that the surfaces of each stone should be "out of winding," that is true planes; and that they should be square to one another.

Great care must be taken that bed joints are not worked hollow. This is sometimes done in order to show a very fine joint on the face without the trouble of carefully dressing the whole bed. It leads to the entire weight being thrown on to the point in front (C in Fig. 108), and a "spall" or piece, S, is splintered off; the stone is then said to be "*flushed*" at this point.

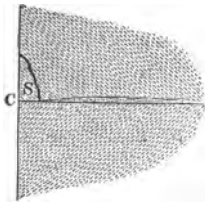

Fig. 108.

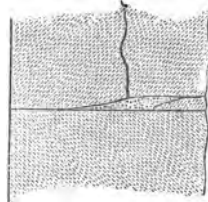

Fig. 109.

With the same object of saving labour, the back of the joint is sometimes worked slack and underpinned, as in Fig. 109. The stone is then supported only at the front and back, and liable to break in the middle, as shown.

Where bed joints are worked convex, the pressure that comes upon them is concentrated upon a single point, and leads to crushing or splitting of the stone.

Where the beds and joints are not carefully worked throughout, they should be so for at least 6 inches in from the face.

Flushed joints are particularly likely to occur with stones that are not laid on their natural beds.

They may be guarded against by raking out the mortar to a depth of an inch or two from the edges of the stones, pointing up again when the work has settled, or by chamfering¹ them off as in the quoins in Fig. 110.

In any important work with fine joints, especially in columns, sheet lead is laid between the stones, which is intended to yield to the irregularities on the bed, and to distribute the pressure.²

¹ *Chamfering* consists in taking off the rectangular *arris* or sharp angle of a stone, so as to form a flat strip, an inch or so in width, at an angle with the face.

² Mr. Kirkaldy has proved by experiment that this is not the case, and that the practice is a bad one.

It should extend only to within about an inch of the outer edges of the stones, so as to leave a clear space between them, and prevent them from bearing upon one another and flushing. This space is generally filled in, nearly to the surface, with composition, and then pointed.

The general directions with regard to bond, given at pp. 2, 38, are easily followed in ashlar masonry.

The lap or bond given to the stones varies, according to the nature of the work, from once to once and a half the depth of the course; and it should under no circumstances be allowed to be less than from 4 to 6 inches, according to the size of the stones.

The best bond for ashlar consists of headers and stretchers¹ alternately on the same course—an arrangement similar to Flemish bond in brickwork (see Fig. 39). It is however seldom executed in this way on account of the expense of so many headers.

In setting ashlar, the stone should first be placed in position dry, to see if it will fit, the upper surface of the last course should then be thoroughly cleaned off and wetted: on this a bed of mortar is evenly laid, with a strip of putty about $\frac{3}{4}$ inch wide along the front edge. The block, with its bed joint well cleaned and wetted, is then laid evenly in its place, and settled by striking it with a mallet.

Ashlar walling is described as “coursed” or “random.”

COURSED ASHLAR walls consist of blocks of the same height throughout each course. This is the most usual form in which ashlar is built, but it is the most expensive, as great waste of material and labour is occasioned by reducing all the stones to the same height.

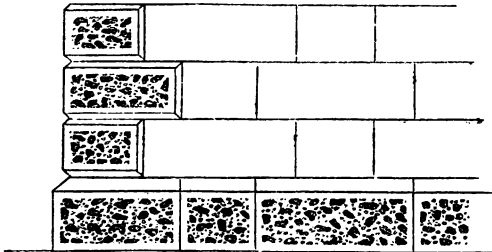

Fig. 110.

Fig. 110 shows coursed ashlar walling, with chamfered and rusticated quoins and plinth.

¹ These are, properly speaking, bricklayers' terms, but may be, and often are, used for convenience with regard to masonry. Sc. *Inbonds and Outbonds*.

RANDOM ASHLAR walls are built with rectangular blocks of all sizes and dimensions. This is a cheaper kind of work, as it enables a larger proportion of the stone as quarried to be used without waste in reducing to fixed sizes; but it is generally considered inferior in appearance to coursed work, and is very seldom adopted.

Rubble¹ — GENERAL REMARKS.—There are several kinds of rubble work, each known by a technical name, depending upon peculiarities in the arrangement of the stones, or in the work upon them.

Some points common to all rubble walls will be considered before the different classes of work are described.

As the beds and joints in rubble work are generally not carefully dressed, the strength of the walling depends greatly upon the mortar, which should be of the best quality.

Considerable skill is required on the part of the builder, who has to work in stones of irregular shape in the most advantageous manner. Such stones should, where possible, be placed on their widest beds, so that they may not be crushed, or act as wedges, and force out the adjacent work.

Headers or thorough bonds should be regularly provided, of sufficient thickness to resist fracture. Their numbers, size, and position will be roughly determined by the considerations mentioned in discussing bond stones at p. 38.

In the inferior classes of rubble the spaces between the stones of irregular shape must be packed in with "spalls,"² and in all cases the "hearting" or inside of the wall should be carefully filled with as large fragments as possible, well bedded in mortar.

All stones in rubble walling should be placed on their natural beds, and as nearly horizontal as the class of work will allow.

The names given to different classes of rubble work vary greatly in different parts of the country.

The following must therefore be taken merely as a general guide, not as a rigid classification adapted to all localities.

RANDOM RUBBLE (*uncoursed*).—In common random rubble work the beds and joints are not dressed, projecting knobs and corners are knocked off with the hammer, and the stones lie together at random, the interstices being filled in with small spalls and mortar. No attention is paid to courses, though each stone should be approximately horizontal.

¹ *Sc. Ruble.*

² Pieces of broken stone. *Sc. Shivers.*

This is a most inferior description of walling, unless it is executed with very good mortar, upon which its strength greatly



Fig. 111.

depends. It requires considerable skill to build such a wall properly. The bond should be carefully attended to, and though it is almost impossible in the roughest work to break joint on every stone, yet long vertical straight joints should not be permitted. The external appearance and method of building random rubble depends entirely upon the nature of the material, which may vary in every gradation from rough intractable boulders to stones with a beautiful cleavage and natural beds nearly as smooth and even as if they had been carefully worked.

Random Rubble built in Courses.—In this walling the work is brought to a level throughout its length at about every 12 or 14 inches in height, so as to form courses of that depth.

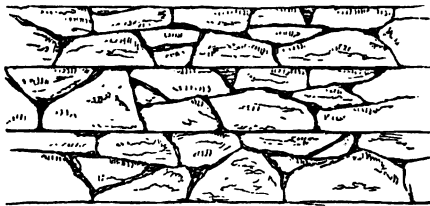

Fig. 112.

The work in each course is built random, and may consist of two, three, or more stones in depth, pinned in with spalls as before described.

SQUARED RUBBLE¹ (*uncoursed*) has the joints and the angles of the faces neatly squared with the tools locally used. The beds are horizontal, and the side joints vertical. This description of rubble is peculiarly adapted for such stones as have a fine cleav-

¹ Sc. "*Snecked rubble*"—the abrupt breaks in the bond being called "*snecks*."

age, affording bed joints which require little or no working. The thickness and length of the stones and style of work depends greatly upon the material. Some quarries furnish a larger pro-

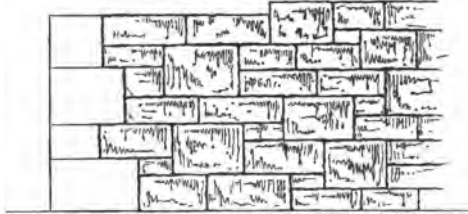

Fig. 113.

portion of large stones than is shown in the sketches, and others consist nearly entirely of thin beds.

In this kind of walling the work is sometimes allowed to run for short lengths into courses, these being frequently broken by high stones reaching from one course into the next above. Such work is often called "*Irregular coursed rubble.*"

Squared Rubble built in Courses is squared rubble brought to a level course throughout its length at every 10 or 14 inches in

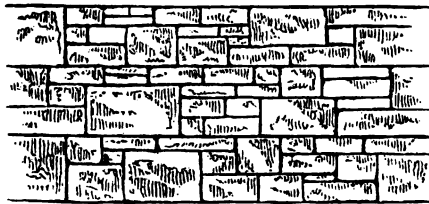

Fig. 114.

height: it is sometimes known as "*irregular coursed rubble brought up to level courses.*"

In squared rubble straight vertical joints are often allowed, so long as they are not more than a foot or so in height, for random work, and not more than the height of a course in work built in courses (see Fig. 319).

In one variety of this rubble the side joints are left splayed to save labour.

Coursed Header Work is rubble similar to that shown in Fig. 114, except that the headers or bondstones are each of the full depth of the course in which they occur, the intervals between them being filled in with smaller stones.

COURSED RUBBLE, or *Regular Coursed Rubble*, consists of stones laid in courses, every stone in the same course being of the same height; the height of the courses may, however, vary from 4 to 8 inches.

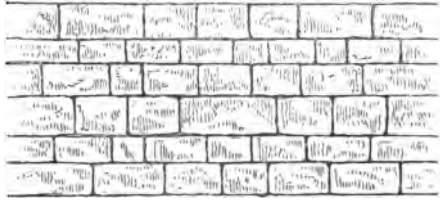

Fig. 115.

With some kinds of stone found in thin layers, and having good natural beds, there is a greater distinction made between the thickness of the courses, three or four courses from $1\frac{1}{2}$ to 3 inches thick, alternating with one or two courses from 4 to 5 inches thick, as shown in Fig. 130.

DRY RUBBLE is rubble (generally "random") built without any mortar. It is the cheapest form of work, but requires considerable skill on the part of the builder.

FLINT RUBBLE is composed of flints and pebbles—or "*popples*"—laid in mortar. It forms a kind of concrete depending upon the mortar for cohesion. Great care must be taken to keep it dry and safe from the action of frost.

The interior of the wall is sometimes filled in with chalk, broken bricks, pebbles, etc.

Walls may be built with the "*rough*" flints just as they are dug out from the chalk, or they may be "*random*"—that is, with the flints irregularly broken.

The stones are frequently "*polled*" or split, and the fractured surfaces placed flush with the face of the walling. The beds of the flints must be pinned up with fragments, so that their upper surfaces are level, or wet will be led into the wall, and long flints must be used as through stones.

Small sharp pieces or "*gallets*" of flint are sometimes stuck into the mortar joints, in which case the work is said to be "*galleted*."

When the stones are split and roughly squared the walling is called "*snapped flint work*."

RUSTIC or POLYGONAL RAG-WORK is built with Kentish Rag or similar stone, in small pieces,

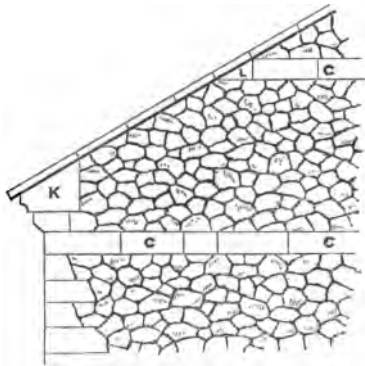

Fig. 116.

which are knocked into irregular shapes and dressed with the hammer, either roughly to fit one another (as in Fig. 116), which is called "*rough picked*;" or with care and accuracy, the stones being carefully worked to regular polygonal forms, in which case the work is said to be "*close picked*."

Walling of this material is sometimes backed in with "*hassock*," a soft stone found in layers with the rag, and unfit for external work.

LACING COURSES.—Walls such as those built with flints, or other small stones, having but little bond in themselves, are frequently strengthened by building in with them lacing courses, consisting of horizontal bands either of ashlar, coursed rubble, or brickwork (see Fig. 116).

Block in Course, or Blocked Course, is a name given to a class of masonry which occupies an intermediate place between ashlar and rubble.

The stones are of large size, so that they must be procured in blocks, not as rubble; but the beds and joints are only roughly dressed, and so the work cannot be described as ashlar.

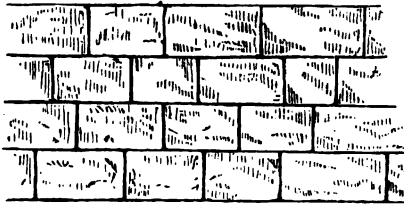

Fig. 117.

This kind of walling is sometimes known as "*hammer-dressed ashlar*." It is used chiefly in engineering works, and seldom, if ever, for ordinary buildings.

Ashlar Facing.—The expense of ashlar masonry prevents it from being used throughout the whole thickness of a wall, except in works of great importance and solidity.

It is therefore frequently used merely as a facing, and is backed in with rubble or brickwork; and by some the term "*ashlar*" is used to apply only to such a facing, not to a solid wall.

Such a construction is open to objections, which are pointed out in Part II.

STONE ARCHES.

The names of different forms of arches and their parts are given at pages 4 and 5.

Cut Stone or Ashlar Arches.—In block stone arches the voussoirs are always cut to a wedge shape.

The curve of the arch having been set out full size on a board, and the number of stones and thickness of arch having been decided, the intrados is divided into as many parts as there are stones, and lines drawn from the centre through these points, till they cut the extrados, give the sides of the voussoirs.

By the aid of the diagram thus laid out, patterns or templates in wood or zinc are made for the use of the stone-cutters, who are thus enabled to work the stones to the required forms.

In setting stone arches the space to be occupied by each voussoir—not forgetting the thickness of the joints—is carefully laid out on the centre,¹ and the position of the stones checked as they are set.

The stones should be set alternately on each side of the centre, so as to weight it evenly.

The keystone should be carefully fitted at the last before it is set, and driven gently into its place with a few taps of a mallet.

When the arch is so long in plan that one stone cannot extend through from front to back, the work must be built with a regular bond along the soffit. The voussoirs are kept at the same width all through, but of different lengths, so as to break the bond in the length of the arch.

Rubble Arches are built of smaller stones, generally roughly dressed to the wedge shape.

They should be built in mortar of good quality, as they depend greatly upon its coherence for their strength.

JOINTS AND CONNECTIONS.

Sometimes greater security is required for joints than that afforded by the adhesion of the mortar and the weight of the stone.

Cases of this are likely to occur in heavy copings on inclined walls—in masonry exposed to severe blows from the sea, and with detached stones not kept in place by surrounding masonry.

There are several methods of giving additional strength to the joints of masonry, the most common of which will now be considered.

¹ The *centre* is a framework of wood having a curved upper surface, and is arranged so as to support the stones of the arch while it is being built.

Metal Connections.—With regard to metal connections it may be said, once for all, that copper or bronze make the best, as they do not oxidise to any great extent. If iron is used, it should be well protected from air or moisture, and also painted or galvanised, or it will rust, increase in bulk, and split the stones. All metals are liable to do the same, more or less, by their expansion and contraction under heat and cold.

Dowelled Joints are formed with slightly tapering pins, or "dowels," which fit into holes made in the stones opposite to one another (see Fig. 118).

The dowels may be rectangular, square, or circular, in section, and formed of hard stone, slate, or metal.

They are sometimes placed vertically in a joint, as in Fig. 119, the upper part of which shows half the hole cut for the dowel, and the lower part shows the top of a dowel in position, or they may be double dovetail in plan, and placed horizontally, as in Fig. 120.

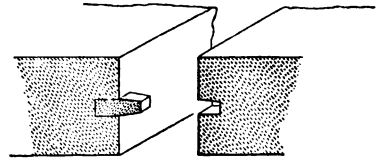

Fig. 118.

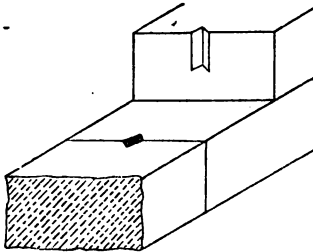

Fig. 119.

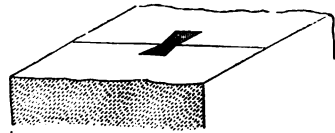

Fig. 120.

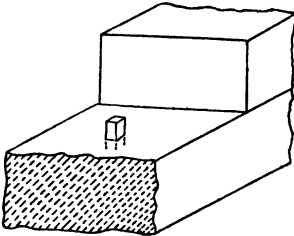

Fig. 121.

Dowels are sometimes made to fit very loosely, and run with lead, cement, or brimstone, but accurate fitting is better.

A short vertical dowel in the centre of a stone is sometimes called a "bed plug" (see Fig. 121), and is useful for copings or heavy stones, built on an inclined

ramp or gable, and for many other purposes.

Joggled Joints are similar to dowelled joints, except that the joggle or projection is a part of the stone, instead of being detached

like the dowel. To leave such a projection in working the stone would cause great labour and waste of material, and it is seldom done in practice.

The word "joggle" is often applied by masons to dowels, and to all sorts of joints in which any portion of one stone enters the other.

Grooved and Tongued Joints.—In these a prolonged joggle or tongue is worked upon one stone, and fits into a groove in the other. A similar joint is used in joinery, and shown in Fig. 210.

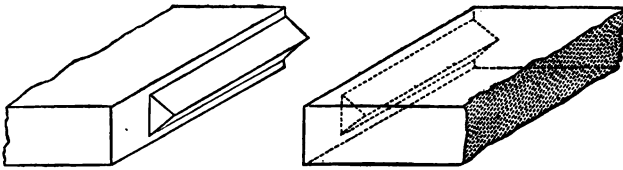

Fig. 122.

A modification of the joint, in which the groove and tongue, or joggles, are angular, is shown in Fig. 122.

A more economical joint is formed by cutting grooves in both the stones, and inserting a metal tongue.

Metal Cramps are generally placed in a channel cut in the upper surface of two stones, having sinkings at the ends, into which the turned-down extremities of the cramp may fit.

The channel should be deep enough to conceal the cramp, and is filled in with lead or cement to protect the latter from oxidation.

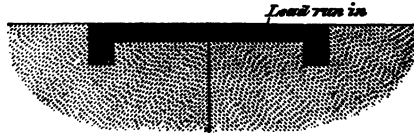

Fig. 123.

If the cramp is run with lead, its returned ends should be jagged, as shown in Fig. 123, to give the lead a better hold upon them. In very important work, the joints may sometimes be strengthened by a cramp and dowel combined, as in Fig. 124.

Lead Plugs are formed by pouring molten lead into dove-tail-shaped plug-holes formed in the stones, as shown in sec-

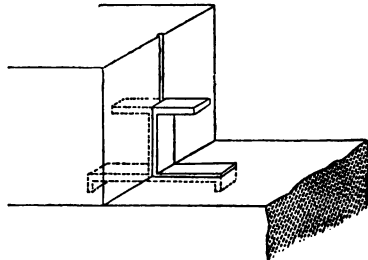

Fig. 124.

tion Fig. 125. The holes slope downwards, in order that the lead may run at once into the ends and corners, so as to fill them completely.

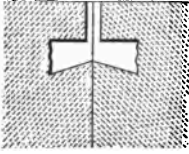

Fig. 125.

Rebated Joints between two stones are made by taking a check out of the end of each, so that they may overlap each other. They are exactly similar to those used in joiners' work, and shown in Fig. 206.

An illustration of their use is given in Fig. 130.

Tabled Joints are those in which a wide projection is left on one stone, fitting into an indentation cut in the other. Joints formed like this are often said to be joggled. They involve a waste of material, and are used only for heavy work subject to concussion, such as the walls of lighthouses.

A similar joint to this is used in carpentry, and shown at T, in Fig. 135.

DRESSINGS.

Quoins are the corner stones of buildings. They play an important part in binding the walls well together at the angles, and are often made conspicuous by better or more pretentious workmanship.

In heavy masonry they frequently project an inch or two from the face of the wall (see Fig. 110), and the margin is either "sunk drafted,"¹ moulded, or chamfered, the face being boldly worked, "rusticated" (see Fig. 110), or left with the rough "rock" or "quarry face."

The quoins of rubble walls are often in ashlar, of a better stone, with close joints—the face being either left rough or worked according to taste.²

In some descriptions of work the quoins are made of the exact height of the courses of rubble, being first set as gauges, to which the latter are levelled; but frequently the quoins are quite independent of the rubble, and irregular in every way—no two stones are of the same size or shape, and the joints abutting against the rubble are left rough and not kept vertical (see Figs. 116, 127). Stone quoins to brick walls should be the exact depth of a certain number of courses, so that they may readily bond in to the brickwork.

¹ *Sunk draft* is a margin, as described at page 39, sunk below the general surface of the stone.

² The different methods of working the faces of stones, and the operations of stone-cutting, do not fall within this course.

SECOND QUOINS, such as those shown at *aa* in Fig. 130, are sometimes used, where the ordinary quoins are small, in order to give additional strength to the angle of the wall. The stretchers may be doubled as well as the headers.

Window Sills (see page 9) should be worked smooth, rubbed, and weathered,¹ so as to get rid of the water as quickly as possible, and throated,² to prevent it from falling on the wall below them.

An ordinary window sill is shown in elevation in Figs. 83 and 319, and also in Fig. 4 and others. The little corbels *yy*, shown below the sill in the latter case, are only for ornament. The most usual form of section is given in Fig. 313.

A groove should be cut along the centre of the upper surface of the sill, to correspond with one in the bed of the oak sill of the window frame, into which a metal water bar (*wb*, Fig. 317) is inserted, to prevent wet from getting in through the joint.

With the same view of preventing the entrance of wet, the stone sill is sometimes checked out to receive the oak sill, as shown in Fig. 315, but this is an expensive construction seldom adopted.

Different methods of finishing the ends of sills are shown in Figs. 83, 311, 312, 316, 317, etc.

Window and Door Jambs.—In the commoner buildings these may be of rubble; but they are more frequently of cut stone even in rubble walling.

They are generally formed with reveals, as explained at page 8, the thickness of stone in front of the check, or sinking for the frame, varying from 6 to 12 inches.

It is important to secure a good bond in the jambs of all openings; every header should go right through the thickness of the wall, the alternate stones stretching along the face.³

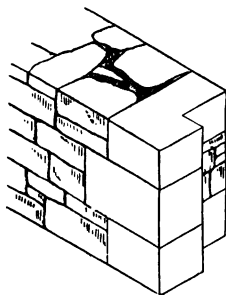

Fig. 126.

The stones forming the jambs—"jambstones"⁴ may be chamfered, moulded on the outer angles, or ornamented in different ways to suit the style of the building.

¹ *Weathering* is dressing off the upper surface of a stone to a slight slope, in order that the rain may not rest upon it.

² *Throating* is cutting a groove or *throat* on the under side of that part of a stone which projects over a wall, in order that the water trickling over the face of the stone may be stopped before it reaches the wall.

³ *Sc. Inbonds and Outbonds.*

⁴ *Sc. Rybates.* The inner rough stone sometimes used at the back of the stretchers instead of rubble is called a *Scuntion*.

To save expense, architraves¹ or other ornamental mouldings are often worked separately in thin strips, or stuck up on edge round the door or window opening to be ornamented.

In other cases the jambs each consist of one long stone on end, the height of the opening, with the architrave worked upon it.

Lintels—Window and Door Heads.—Stone lintels may be used to cover any narrow opening in a wall.

When intended to form a “head” to a door or window opening, the lintel rests on the jambs, and the under side in some cases is checked out so as to form a reveal for the head of the frame.

It is better, however, that the under side or “soffit” of the lintel should be left flush throughout, a wood lintel with relieving arch, concrete beam, or flat arch, supporting the wall behind it, being kept higher than that of the stone lintel, so that room is afforded for the head of the wood frame (see Figs. 313, 317).

It is often advisable to relieve the stone lintel of the weight of the wall above it. This may be done by a discharging² arch, which either forms a feature in the elevation, as in Fig. 127, or, if that be objectionable, the walling above may be formed in a sort of flat arch without being conspicuous (see Fig. 312).

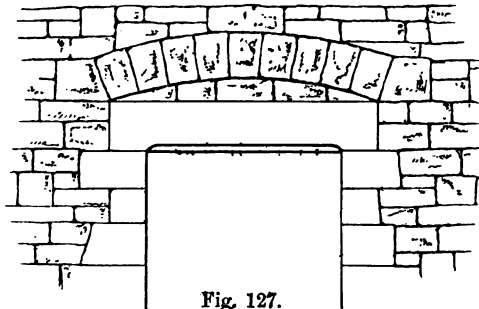

Fig. 127.

When a discharging arch is used, it is sometimes made of the same span as the opening, so that it rests upon the ends of the lintel instead of being just clear of them as shown in the figure.

The “core,” or portion between the soffit of the relieving arch and the top of the lintel, should be left out until the whole work has taken its bearing, or the settlement of the arch may cause the core to bear upon and to break the lintel.

¹ An *architrave* is an ornamental border formed round an opening such as that for a door or window.

² *See Saving arch.*

String Courses (see p. 7) should, as a rule, extend well into the thickness of a wall to give it strength.

They should, if of sufficient projection, be weathered and throated.

Stone string courses in brickwork should be of the exact height of a certain number of courses of bricks (see Fig. 128), otherwise they will necessitate bricks being cut, or upset the bond.

The stones are sometimes united to one another by iron cramps, so as to form a continuous band round the building.

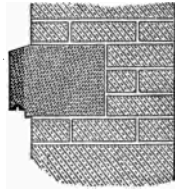

Fig. 128.

Corbels are stones projecting from a wall, generally in order to form a support, as in Fig. 201.

When the weight to be borne is very great, and in other cases (see p. 8), several courses may be corbelled or gathered over, as already described.

Eaves Courses (see p. 7). — An example of a stone eaves course arranged so as to support an iron gutter is shown in Fig. 256.

Copings¹ (see p. 6) should be in as long stones as possible, to avoid joints which admit the wet.

The upper surface should be weathered, and horizontal copings should be throated.

The stones of an ashlar coping may be cramped or dowed together, or united by lead plugs.

On a steep ramp or gable it is necessary to dowel the coping to the wall to prevent it from slipping down the slope, or the same object may be attained by working the coping with a horizontal bed, and of such a depth as to enter the wall, as shown at L in Fig. 130. This is not, however, usually done with every stone, but only at intervals in the length of the coping.

A common construction is to cut the backs of these stones vertically downwards from the point *e*, so that they are triangular in section (see Fig. 116), but this is not so good a form as that shown at L in Fig. 130; especially, in a gable of steep pitch, the height of the stone would be greater than its base, and it would have a tendency to tilt over when the thrust came upon it.

The joints of inclined copings may be rebated as shown in Fig. 130, so that as the wet which gets in at the top of the joint cannot flow upwards in the rebate, it is prevented from entering the wall.

¹ Sc. *Copes*.

SADDLE-BACK COPING.—Fig. 129 is the section of a saddle-backed coping; the top, instead of being formed by two plane surfaces as shown, is frequently rounded.

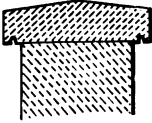

Fig. 129.

PARALLEL COPING is one of which the upper and lower surfaces are parallel. Such a coping may be used for gables or ramps where it is laid at an inclination, and therefore a sloping transverse surface to throw the water off is not necessary. A coping¹ of this kind is shown in section in Fig. 260.

FEATHER-EDGED COPING.—Fig. 227 shows this form of coping on a parapet wall. It is weathered in one direction only, so as to throw off the water into a gutter on the inside.

COPINGS FOR RUBBLE WALLS may be formed with long stones laid horizontally on the top, and either left rough, or worked; or they may have a rough coping consisting of flat stones on edge. These are sometimes alternately high and low, so as to present a rugged and picturesque appearance.

The coping of a pier or column is called the *Capital*, that of a chimney is called the *Cap*.

Skew Corbel.²

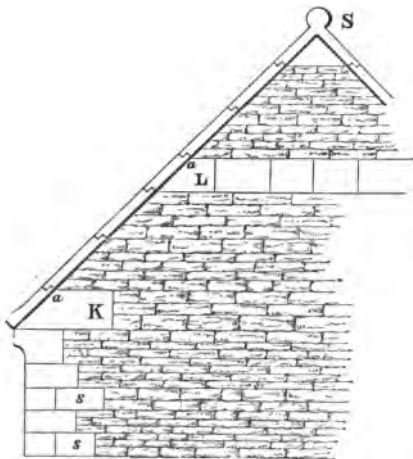

Fig. 130.

KNEELER or **KNEE STONE** is the stone at the foot of a coping on a gable or ramped wall. It is sometimes cut off vertically downwards from the point *a* (see Fig. 116), but such a construction is objectionable for the reasons given above with regard to the stone *L*. It is better that the kneeler should tail into the wall as shown at *K* in Fig. 130, so that it has a base much greater than its height, and the rubble above it helps to keep it in its place.

Saddlestone is that forming the apex of a gable; also called *Ridgestone* and *Apex-stone*.

Cornices (see p. 6) should project well, so as to protect the wall from wet, and should be weathered and throated.

It is important that sufficient of the cornice should rest on the

¹ Sc. A coping in this position is called a *skew*. The term includes the portion of wall above the roof.

² Sc. *Club-skew*.

wall to balance the projecting portion, or it will press unfairly on the front of the wall and be unstable.

Sometimes the stones are left a little high at the joints between them, as at *x*, Fig. 131. This is called "*saddling the joints*,"¹ and is intended to throw the water off them, but it involves much expense in extra labour and waste of stone.

The joints between the stones of the cornice, and also those of the working course or parapet above, are often secured by lead plugs (see p. 49).

The cornice may itself form the uppermost member of the wall, or it may be surmounted by a blocking course, by a parapet wall, or by a balustrade.

CORNICE.—In the first case a raglet² may be required to receive the flashing or apron of a lead gutter at the back of the cornice, as shown in Fig. 131,

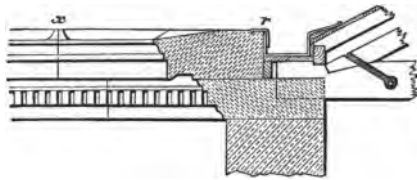

Fig. 131.

or the gutter may be formed in the stone itself, as in Fig. 258, care being taken to line the hollow with lead or cement if the stone is at all porous.

CORNICE AND BLOCKING COURSE.—This may be seen in the section Fig. 270. The top of the blocking course is generally grooved to receive the lead of the gutter or apron.

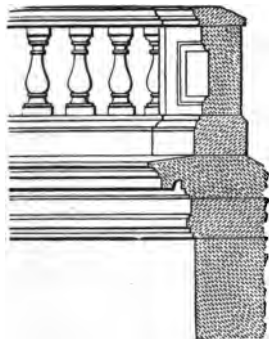

Fig. 132.

CORNICE AND BALUSTRADE.—This is shown in Fig. 132. The small columns are called balusters, and are divided into groups of seven or nine by solid panelled blocks called "*pedestals*." In Fig. 132 a half pedestal is shown in elevation at the angle.

CORNICE AND PARAPET.—This is a similar construction to that last mentioned, except that the cornice is surmounted by a solid wall. See Fig. 226 and others.

¹ Sometimes called "*water jointing*."

² See p. 150.

CHAPTER IV.

CARPENTRY.

JOINTS AND FASTENINGS.

General Remarks.—In designing joints and fastenings the carpenter should bear in mind not only the present position and form of the parts he places in contact, but also the changes that will certainly occur from the shrinking and settlement of the timbers, otherwise pressures will come upon parts not intended to receive them, and the pieces will frequently be crushed or split at the points of contact.

The principles which should be adhered to in designing joints and fastenings are laid down by Professor Rankine as follows:—

1. To cut the joints and arrange the fastenings so as to weaken the pieces of timber that they connect as little as possible.
2. To place each abutting surface in a joint as nearly as possible perpendicular to the pressure which it has to transmit.
3. To proportion the area of each surface to the pressure which it has to bear, so that the timber may be safe against injury under the heaviest load which occurs in practice, and to form and fit every pair of such surfaces accurately, in order to distribute the stress uniformly.
4. To proportion the fastenings so that they may be of equal strength with the pieces which they connect.
5. To place the fastenings in each piece of timber so that there shall be sufficient resistance to the giving way of the joint by the fastenings shearing or crushing their way through the timber.

The simplest forms of joints are the best, so that the parts may be fitted with the least possible inconvenience. Double abutments, such as that in Fig. 166, should be avoided, as they are difficult to fit; moreover, when the timber shrinks the whole strain may be thrown upon one of them.

Classification.—JOINTS.—The various forms of joints used in carpentry may be arranged as follows:—¹

Nature of Joint.	Form of Joint used, and page in which it is described.
Joints for lengthening "ties" or beams in tension	} Lapping, p. 57. Fishing, p. 58.
Joints for lengthening "struts" or beams in compression	
Joints for lengthening beams under cross strain	} Scarfing, p. 59.
Joints for beams bearing on beams	} Tabling, p. 58.
	} Halving, p. 62. Dovetailing, p. 63.
	} Notching, p. 63. Cogging, p. 65.
	} Tusk tenon, p. 67.
Joints for beams on posts	} Chase mortises, p. 71.
Joints for posts on beams	} Tenon, p. 65. Joggle, p. 68.
Joints connecting struts with ties	} Bridle, p. 72.
Joints connecting struts with posts	} Oblique tenon, p. 69. Circular, p. 72.
Strut and beam joints	} Bridle, p. 72.
Tie and brace joints	} Mitre, p. 73.
Suspending pieces	} Dovetailing, p. 74. Notching, p. 64. p. 74.

FASTENINGS are used for making joints more secure, and may be classified thus:—

- | | | | |
|------------------|--------------------|-----------------------------------|-------------------|
| Wedges, p. 75. | } Trenails, p. 77. | | |
| Keys, p. 76. | | } Pins { Screws, p. 77. | |
| Pins { | } Straps, p. 78. | } Bolts, p. 77. | |
| | | | Wood pins, p. 76. |
| | | | Nails, p. 77. |
| Spikes, p. 77. | Sockets, p. 80. | | |

JOINTS.

Beams are joined in the direction of their length by "lapping," "fishing," and "scarfing."

Lapping.—This consists in simply laying one beam over the

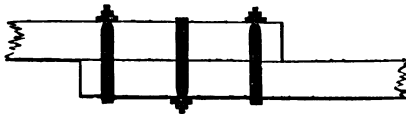

Fig. 133.

other for a certain length, and binding them together with straps, as shown in elevation in Fig. 133, or, if the joint is to stand a tensional strain, with bolts.

¹ A modification of the arrangement given in Rankine's *Civil Engineering*, p. 453.

Dr. Young¹ says of this joint: "We acknowledge that this will appear an artless and clumsy tie-beam, but we only say that it will be stronger than any that is more artificially made up of the same thickness of timber."

Fishing.—The ends of the pieces are butted together, and an iron or wooden plate or "*fish-piece*" is fastened on each side of the joint by bolts passing through the beam. Fig. 134 is the plan of a joint fished with wooden plates, and Fig. 137 shows one fished with iron plates.

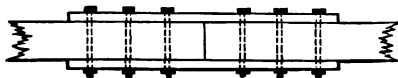

Fig. 134.

The bolts should be placed chequerwise (see Fig. 143), so that the fish plates and timbers are not cut through by more than one bolt hole at any cross section.

When subjected to tension, the chief strain comes upon the bolts (which are but slightly assisted by the friction between the "*fish-pieces*" and beam), these are loosened by the slightest shrinkage of the timber, and they then press upon the fibres, crush them, and thus cause the joint to yield.

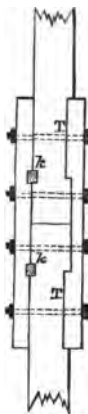

Fig. 135.

This dependence upon the bolts may be lessened by indenting or "*tabling*" the parts together, as at T T, Fig. 135, or by inserting keys, *k k*, but these arrangements decrease the section and strength of the beams.

This is a very strong form of joint, but clumsy in appearance. It is useful for concealed work, or in rough and temporary structures, such as scaffolds.

When a beam is fished to resist compression, there should be plates on all the four sides.

A fished joint is manifestly unsuited to resist a cross strain.

Scarfed joints are often fished with iron plates to assist the scarf (see Fig. 139, etc.) These plates also serve to protect the wood from being crushed by the bolts. They are sometimes turned down at the ends into the timber, so as to assist it in resisting tensional strains. It has been recommended that the indented ends should not be opposite to one another, as in Fig. 141, for in that position they cut into the timber at the same

¹ *Encyclopædia Britannica.*

cross section, and weaken it more than if they are placed as in Fig. 143.¹

Scarfing.—GENERAL REMARKS.—Figs. 137 to 145 show sections of several forms of “scarfs”²—taken chiefly from Tredgold’s work on Carpentry. It will be seen that they present a neater appearance than fished joints, inasmuch as the pieces are cut to fit one another, so that the resulting beam is of the same thickness throughout.

Much ingenuity has been expended in devising scarfs of very intricate form, but the simplest are the best, as they are the easiest to fit accurately together.

Many of the intricate forms given in books will be found to be useless upon being tested by the following principles laid down by Tredgold:—

When two pieces of timber are tabled together, as shown in Fig. 136, if a tensional strain in the direction of the arrow comes upon the joint, it is evident that it would tend to shear off the pieces *a h i c*, *c i f d*, by sliding them along the grain, also to crush the ends of the fibres at *c i*, and further to tear the beams asunder at *b c*, *i k*.

As “the weakest part is the strength of the whole,” there would be no use in making *b c* wide enough to resist tearing if the piece *a h i c* were so weak as to be dragged off, and *vice versa*.

In such a scarf, then, the strength of *c i* to resist compression, that of *c i f d* and *c i h a* to resist shearing, and of *b c* or *i k* to resist tearing, should all be equal.³

The bearing surfaces of indents which undergo compression, should be at right angles to the direction of the compressing force; there is a temptation to make them oblique (see Fig. 138), in order to hold the pieces together close side by side. This is not an objection when the beam is exposed only to tensional strains, but under compression, the angular point of one piece tends to tear or split the other.

In the succeeding figures it will be noticed that the scarfs are frequently aided in their resistance to strains by the use of fish plates, of hard wood keys, and of wedges. In applying these accessories to scarfs, their strength must be proportioned to that of the parts of the scarf itself—*e. g.* the strength of the fish plates

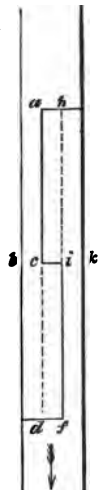

Fig. 136.

¹ Seddons' Notes on the Building Trades.

² See *Scarves*.

³ See Tredgold's Rules, page 62.

(after being weakened by the holes for the bolts) must be equal to that of the beams to be united; and the resistance to shearing afforded by the keys must be equal to that of the portion of the scarf on either side.

DIFFERENT FORMS OF SCARFS.—From the above remarks, it will be manifest that the form of the scarf should be varied to suit the nature of the strain it is to bear.



Scarf to resist Compression.—Fig. 137 shows in elevation a very simple form of scarf, evidently well adapted to resist compression. The bearing surfaces are large, and perpendicular to the compressing force. Its form does not help it to resist tension. Under a tensional strain it would depend entirely upon the bolts to hold it together. Nor is it adapted for a cross strain, which would bend the iron plates and tear out the bolts.

A modification of this scarf is sometimes formed like that in Fig. 141, but when intended to resist compression Fig. 137. only, the keys *k k* are not required. The indentations at the ends of the scarf keep the pieces close side by side.

Any scarf containing oblique bearing surfaces is not adapted to resist compression, for reasons already given.

Scarf to resist Tension.—The scarf shown in Fig. 138 is often used for beams to resist a tensional strain. It will hold without

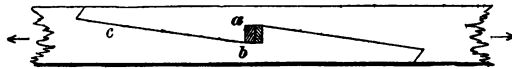

Fig. 138.

the aid of bolts or straps, but the triangle *abc* offers a weaker resistance to the pressure of the wedges than when the joint is left square, as in Fig. 140.

A splayed angle or "sally" is formed at each end to hold the pieces together side by side.

The oblique surfaces of this scarf make it ill adapted to resist compression, and the angles which receive the splayed ends are liable to be split by their pressure.

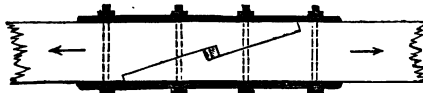

Fig. 139.

Fig. 139 is a modification of the last, often used in preference.

Scarf to resist both Tension and Compression.—The form of scarf shown in Fig. 140 is well adapted to resist both tension and compression, even independently of bolts and plates.

It is evidently weak in cross section, on account of the timber being so much cut away, and therefore it is not fit to withstand a transverse strain.

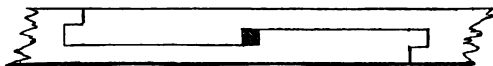

Fig. 140.

The wedges shown in the centre are required only when bolts are to be added, in which case they are used to bring the parts of the joint up to their eventual position before the bolts are inserted, so that there may be no violent strain upon the latter.

Fig. 141 shows a modification of the last, in which the tabling

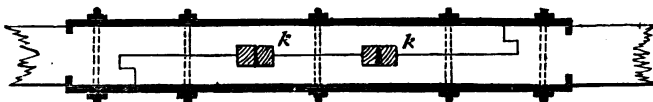

Fig. 141.

is avoided, and the necessary resistance to tension is given by means of keys of hard wood, *k k*, as shown; or pairs of wedges such as that shown in Fig. 140 may be used with advantage.

Scarf to resist Cross Strain.—When a beam is subjected to a transverse strain, the fibres of its upper part are compressed, and those of the lower portion distended, as shown in an exaggerated form by the dotted lines in Fig. 142.



Fig. 142.

In scarfing such a beam, therefore, the indents in the upper or compressed portion should be kept square and perpendicular to the pressure, while those in the lower, or distended part, may be oblique, as they have to resist tension only.

The strength of the scarf is increased by inclining *a b* so as to have as great a thickness as possible at *c b*. The angle at *b* tends to hold the pieces together.

It has been found by experiment¹ that a joint to resist cross strain is stronger when scarfed vertically through its depth, as in

¹ By Colonel Beaufoy. See Barlow's *Strength of Materials*, Art. 68.

Fig. 143, than when the scarf is formed flatwise across its width, as is usually the case.



Fig. 143.

Scarf to resist Cross Strain and Tension.—If, in addition to transverse pressure, the beam is exposed to a strain in the direction of its length, its resistance to tension is afforded by indenting it, and inserting wedges as shown in Fig. 144.

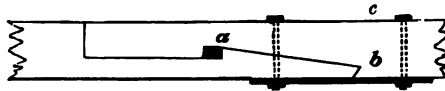

Fig. 144.

In this scarf the angle at *a* is rather weak, but the line *ab* is necessarily oblique, in order to get a sufficient thickness at *bc* to resist the transverse strain.

Scarfing Wall Plates.—Fig. 145 shows the usual way of scarfing wall plates. The wedge-shaped portion is technically known as the “calf,” or “kerf.”

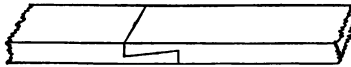

Fig. 145.

TREDGOLD'S RULES.—Tredgold gave the following practical rules for proportioning the different parts of a scarf, according to the strength possessed by the kind of timber in which it is formed, to resist tensional, compressible, or shearing forces, respectively.

In Fig. 136, *cd* must be to *cb* in the ratio that the force to resist sliding bears to the direct cohesion of the material—that is,

In Oak, Ash, and Elm, *cd* must be equal to from 8 to 10 times *cb*.

In Fir and other straight-grained woods *cd* must be equal to from 16 to 20 times *cb*.

The sum of the depth of the indents should equal $1\frac{1}{2}$ the depth of the beam. *

The length of scarf should bear the following proportions to the depth of the beam.

	Without Bolts.	With Bolts.	With Bolts and Indents.
Hard Wood (Oak, Ash, Elm)	6 times.	3 times.	2 times.
Fir and other straight-grained woods	12 „	6 „	4 „

Halving of the simplest kind is shown in Fig. 146. Half the thickness of each piece is checked out, and the remaining portion of one just fits into the check in the other—the upper and under surfaces of the pieces being flush. This is a common way of joining wall plates or other timbers, at an angle where there is not room to let the ends project so as to cross one another.

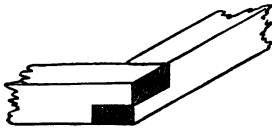

Fig. 146.

BEVELLED HALVING.—In this joint the surfaces of the checks are splayed up and down, as shown. If the lower beam is firmly bedded, and the upper beam has a weight upon it, so that the surfaces are kept close together, their splayed form prevents the upper beam from being drawn away in the direction of its length, and greatly strengthens the joint.

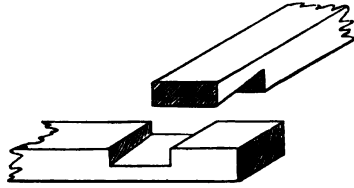

Fig. 147.

DOVETAIL HALVING, see below.

Dovetails are so called from the shape of the pieces cut to fit one another.

They are objectionable in carpentry, because the wood shrinks considerably more across the grain than along it. The consequence is, that as *a b* (Fig. 148) shrinks more than *c d*, it is easily drawn partly out, and does not form a firm connection. The joint is, moreover, very weak at the angles *w w*. This is sometimes improved by cutting shoulders to the dovetail, as at *s s* in Fig. 149.

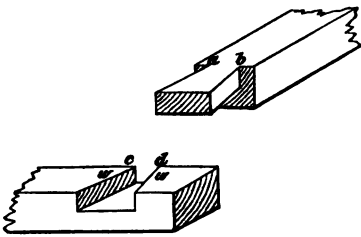

Fig. 148.

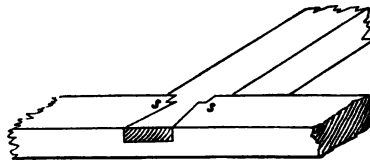

Fig. 149.

Dovetails are not liable to the same objections when the grain in both pieces runs the same way, but in that case, if the timber shrinks, or is strained in the direction of its length, the cheeks are very liable to be split off.

DOVETAIL HALVING (Fig. 148) is a joint in which the dovetail is half the thickness of the piece upon which it is cut, and the notch to receive it half the thickness of the other piece.

See **DOVETAIL NOTCH**, page 64; and **DOVETAIL TENONS**, page 68.

Notching.—A beam resting upon another may be notched as shown in Fig. 150.

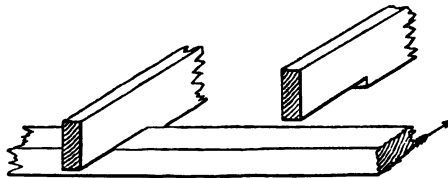

Fig. 150.

Joists are sometimes thus fitted to wall plates, and when the joists differ in depth the depth of the notches is also varied so as to bring the upper surfaces of the joists to the same level. It will be seen there is nothing to tie the wall plate in toward the direction of the arrow.

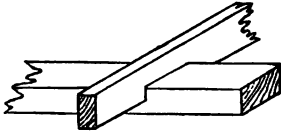

Fig. 151.

In other cases the end of the joist projects, and is left on as shown in Fig. 151; it then grasps the wall plate and holds it in.

DOUBLE NOTCHING.—If the notch is required to be a deep one, half of it may be taken out of each timber, as shown in Fig. 152.

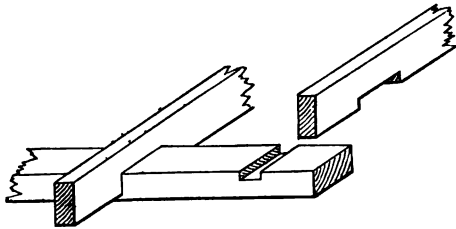

Fig. 152.

When each timber is notched to half its own depth, this joint becomes another form of *halving* (see page 62).

DOVETAIL NOTCH.—This is a good way of joining wall plates at angles. The inside of the joint is dovetailed, and the outer side is left straight.

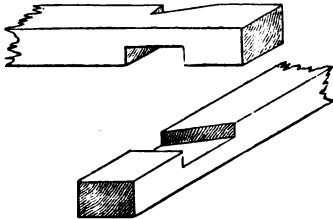

Fig. 153.

Sometimes the joint is tightened up by a wedge driven in on the straight side.

The defect of the dovetail is partly remedied by the grasp the projection of the upper beam has upon the lower.

TREDGOLD'S NOTCH.—The form of joint shown in Fig. 154 was recommended by Tredgold as a substitute for the dovetail, but is seldom, if ever, used in practice.

A similar form was recommended by the same authority for uniting the ends of a collar tie to the rafters (see page 74).

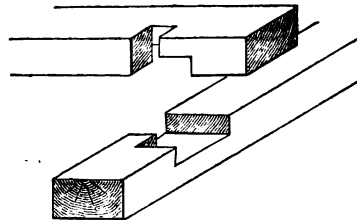

Fig. 154.

“**Cogging,**” “**CORKING,**” or “**CAULKING.**”—In this joint (see Fig. 155), the notch on the lower beam is only partly cut out, leaving a piece or “**cog**” (like that of a cogged wheel) uncut. The upper beam contains a small notch only wide enough to receive the cog.

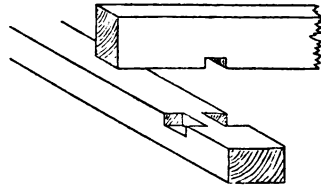

Fig. 155.

“*Cogging*” has the following advantages over *notching*.

The upper beam is kept at its full thickness at the point of support, and is therefore slightly stronger than when notched.

The cog gives the upper beam a hold on the lower, even when its end does not project beyond the latter.

Joists or binders may thus be coggied on to wall plates: if they project beyond the wall plate, as dotted in Fig. 156, the cog may be made broader, but if not, the cog must be narrow and kept toward the inside, so that there may be sufficient substance of timber (*xy*) on the joist beyond it to resist the strain.

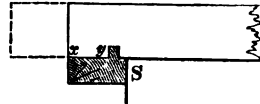

Fig. 156.

The above arrangement takes a considerable piece out of the lower beam. When this is supported throughout, as in a wall plate, it is of no consequence, but, if it spans an opening, it is desirable to weaken it as little as possible.

In such a case, for instance, as coggied joists on to binders (see Fig. 198), or purlins on to principal rafters, the notches in the bearer are made very small, only about an inch or so in depth, and extending inwards about the same distance from the sides of the beam.

Mortise and Tenon Joints. COMMON TENON.—The simplest form of this joint is when a vertical timber A meets a horizontal beam B at right angles.

In Figs. 157, 158 the *Tenon* T is formed by dividing the end of A into three,¹ and cutting out rectangular pieces on both sides, each equal to the part left in the middle.

The *Mortise* is a rectangular hole cut to receive the tenon. The sides C C

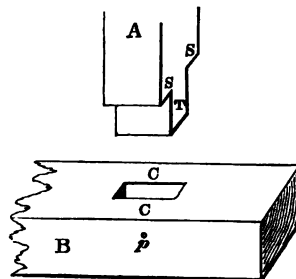

Fig. 157.

¹ The tenon is not necessarily $\frac{1}{4}$ the width of the timber, but may be made in any proportion so long as it is thick enough to withstand the strain upon it.

(Fig. 158) of the mortise are called the *Cheeks*; the surfaces C C (Fig. 157), on which the shoulders of the tenon rest, are sometimes called the *abutment cheeks*.

The springing of the tenon from the beam is called its "*root*" (*r*, Fig. 158); SS are the *shoulders*, and *p* (Fig. 157) the *pinhole*, which is generally placed at $\frac{1}{3}$ the length of the tenon from the shoulder, and is in diameter equal to $\frac{1}{4}$ the thickness of the tenon.

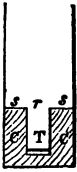

Fig. 158.

If the tenon reached exactly to the bottom of the mortise, it would take its share of the pressure on the post, but it is difficult to make it do so with accuracy, especially as the mortise cut across the grain shrinks more in depth than does the tenon cut along the grain; in practice it is therefore generally made a little shorter than the depth of the mortise, so that the shoulders may bear firmly upon the sill, which is more important.

When the post is likely to be subject to an equal strain on both sides, the cheeks of the mortise should be of equal thickness.

If there is likely to be more strain from one side, then the opposite cheek should be made thicker, so that it may offer more resistance to the tenon being forced through it.

When a horizontal beam is framed into another, and they are subject to a downward strain, as in the case of joists framed into a girder, the position and form of the mortise and tenon will be determined by other considerations.

It has already been stated (page 61), that when a beam is subjected to a transverse strain, the fibres of the upper portion are compressed, and those of the lower portion extended. In the central line dividing these portions from one another there is neither compression nor extension, and it is therefore called the "*neutral axis*."¹

The mortise should be placed in the neutral axis of the girder, where the cutting of the fibres will weaken the girder the least, and where the mortise itself, and the tenon within it, will be free from tension or compression.

With regard to the position of the tenon on the joist, the lower down it is the less likely is it to be broken, because the mutual pressures of the butting surfaces above it protect it from cross

¹ The neutral axis is coincident with the central line only so long as the *limit of elasticity* has not been exceeded—that is, so long as the timber can recover its former position when the strain is taken off. Beyond this limit its position changes, as explained in Part III.

strain, and also because there is a greater thickness of timber above it to be bent, or torn off, under a breaking weight.

The tenon must not, however, be so low down that there is not sufficient thickness of wood left below the mortise to support it.

It is evidently desirable for the strength of the tenon that it should be as large as possible, but in the ordinary form, above described, this would necessitate a large mortise, and very much weaken the girder. That form, therefore, is not adapted for joints intended to bear a downward strain, for which the "*tusk tenon*," about to be described, should always be used.

TUSK TENON.¹—This form was devised in order to give the tenon as deep a bearing as possible at the root, without greatly increasing the size of the mortise, and thus weakening the girder.

This object is effected by adding below the tenon, *T*, the *Tusk*, *t*, having a *Shoulder*, *s*, which penetrates the girder to a depth equal to $\frac{1}{8}$ of the depth of the joist; above the tenon is formed the *Horn*, *h*, the lower end of which projects to the same extent as the tusk.

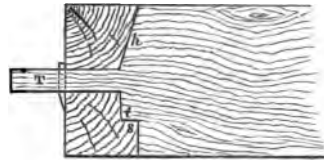

Fig. 159.

It will be seen that the strength of the tenon, between *h* and *t* is immensely increased as compared with the common form, while the mortise is not made much larger.

The depth or thickness of the tenon is generally about $\frac{1}{8}$ of the depth of the beam.

It may be carried right through a narrow girder and pinned outside, as shown in Fig. 159.

In thicker girders it may penetrate a distance equal to twice its own depth, and is pinned through the top of the girder, as in Fig. 160.

Sometimes tenons are formed with a double tusk, but that form is not to be recommended (see p. 56).

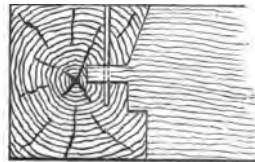

Fig. 160.

The mortise should, for the reasons stated above, be in the neutral axis or centre line of the girder, as shown in Fig. 159; practically, however, it is generally placed with its lower edge *on* the centre line, as in Fig. 160, by which arrangement the tenon is in the compressed portion, and the tusk in the extended portion of the girder.

¹ Sometimes called *shouldered tenon*.

Tredgold recommends that the tenon should be $\frac{1}{3}$ of the depth of the joist above its lower edge. This recommendation cannot always be followed without placing the mortise out of its proper position in the neutral axis, and thus weakening the girder.

For example, when the girder and joist are of equal depth, as in Fig. 159, the tenon must be kept half-way up the joist, as shown, or the mortise would be below the neutral axis—would cut the extended fibres of the girder, and weaken it.

Again, in some cases the relative position of the girder and beam is determined by the space required by other parts of the framing—for instance, in a framed floor (see Fig. 197) more room must be left above for the bridging joists than below for the ceiling joists. This necessitates the tenon being higher, to bring it into the neutral axis of the girder.

In every case it should be considered whether the girder or the joists can best afford to be weakened; if the former has an excess of strength, the tenon may be kept low, so as to strengthen the joist; but if the joist has more strength to spare than the girder, the mortise should be in the neutral axis of the latter, even though the tenon may be high up on the joist.

In practice it more frequently happens that the joists, rather than the girders, have an excess of strength; so it is usual with carpenters to place the mortises with their lower edges on the neutral axis, and to let the position of the tenons on the joists be arranged to suit them.

DOUBLE TENONS are often used in joinery (see Fig. 286), but should be avoided in carpentry, as they weaken the timber into which they are framed, and both tenons seldom bear equally, so that a greater strain is thrown upon one of them than it is intended to support.

STUB TENON (or *joggle*) is a very short tenon, used where it is only required to prevent lateral motion—for example, to keep a post in its place upon a sill.

HOUSING is a term also sometimes applied to the above, but generally used when the *whole* of the end of one piece of timber is let for a short distance—or “housed”—into another (see Joinery, p. 172).

DOVETAIL TENONS are those in which one side of the tenon is splayed so as to form half a dovetail, the other side straight. The mortise is also splayed on one side, and is made rather wider than the tenon, which is placed in position, pressed well up against the

dovetailed side of the mortise, and then secured by a wedge driven into the interval left on the straight side.

NOTCHED TENONS have one side notched and the other straight; one side of the mortise is also notched to correspond, and the tenon secured by a wedge on the other side.

OBLIQUE TENONS.—When timbers are joined at an angle the tenon has to be modified in form. If constructed as in Fig. 161, it would be very difficult to work the mortise to receive it; moreover, the long tenon would have a tendency to tear up the joints in case of any settlement of the inclined beam; and further, it would be almost impossible to get the tenon into the mortise when the pieces to be joined formed part of a system of framing.

These evils may be remedied by cutting off the end of the beam, as shown at *a*, Fig. 162.

Fig. 161.¹

Fig. 162.

This is the simplest mortise and tenon for oblique joints, but the only resistance it affords is that offered by the strength of the tenon, which is liable to be crushed, and would in large carpentry works be quite insufficient to meet the heavy strains that might come upon it.¹

To remedy this, the cheeks of the mortise are cut down, as in Fig. 163, to the line *d b*, so that while the tenon is retained to prevent lateral motion, the whole width of the beam itself presses against the abutment *a d*, by which a much larger bearing surface is obtained.

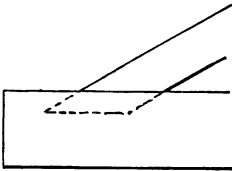
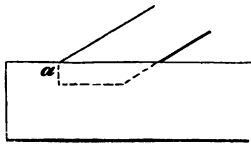
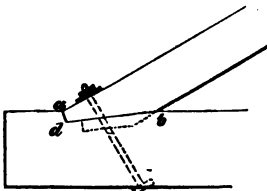

Fig. 163.

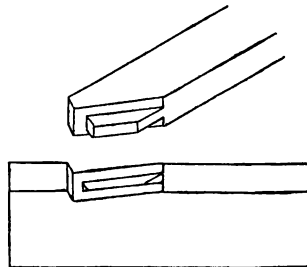

Fig. 164.

Figs. 163, 164 show the joint as frequently constructed for the

¹ From Newland's *Carpenters' and Joiners' Assistant*.

junction of a rafter and tie beam. Tredgold recommends that the depth $a d$ should be greater than half the depth of the rafter, and at right angles to $d b$. It is generally kept shallow from a fear of weakening the tie beam; except for this reason, the deeper $a d$ is made the better, and it is often cut perpendicular to the upper surface or "back" of the rafter, as shown in Fig. 163.

The joint in Fig. 165 is a modification of the last. The point at a is left on only if the boarding of the roof will be visible from the inside; if not, it may be cut off, and an abutment formed to receive a strap like that shown in Fig. 173.

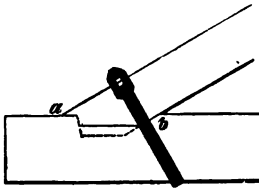

Fig. 165.

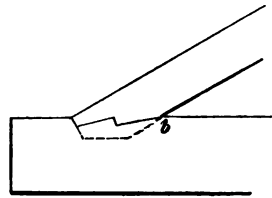

Fig. 166.

Fig. 166 shows a joint with a double abutment. This joint is very difficult to fit with accuracy, and is open to the objections stated at p. 56, but it is sometimes used when the angle of the joint is very oblique, and when there is consequently a large bearing surface.

In putting such joints together they should be left slack at b , so as to allow for settlement of the framing.

As the piece of the tie beam beyond the foot of the rafter would have to be left inconveniently long to prevent its being shorn off, it is relieved of some of the pressure, and the joint is secured by means of a strap or bolt, which also serves to keep the rafter in position. The relative merits of these fastenings are pointed out at page 78.

In framing an inclined beam into a post either at its head or foot a tenon joint is used.

It is advantageous to make the head of the post larger (as shown at X in Fig. 167), so as to get an abutment square to the inclined beam.

If the head of the post be not large enough to afford the square abutment, it may be cut as at Y.

The tenon should be made, if possible, the whole depth of the inclined beam, but in cases where the top of the post is cut off close to the back of the rafter, as in some roofs (see Fig. 168), the tenon is necessarily made narrower in order to leave some

wood on the post above it to form a strong upper cheek to the mortise.

In all cases the joint should be left a little open at a , so that when the framing settles it may not bear too severely upon the angle at the top of the rafter.

The same remarks apply to joints at the feet of posts. (See the lower part of Fig. 167.)

When the extremities of the post cannot be enlarged the inclined beams may be tenoned into it, as in Fig. 168. It will be seen that this arrangement weakens the post, and reduces the size of the tenon. Whereas the form in Fig. 169 gives a very inclined abutment.

Many other positions in which the mortise and tenon are

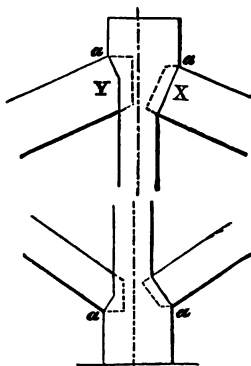

Fig. 167.

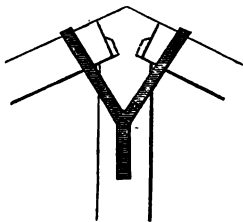

Fig. 168.

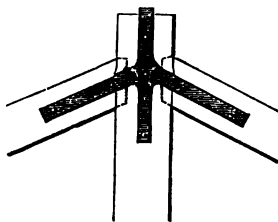

Fig. 169.

applicable will be seen in the different examples of framing throughout these notes.

Chase-mortises, sometimes called **PULLEY-MORTISES**. — If a piece of timber has to be framed in between two beams already fixed, it is evident that the tenons could not be got into ordinary mortise holes.

To enable the cross-piece to be fixed a chase is cut, as shown in Fig. 170, leading to the mortice, m , and the cross-piece is first held obliquely until the tenon enters the end of the chase at a , whence it is slid along into its place at m .

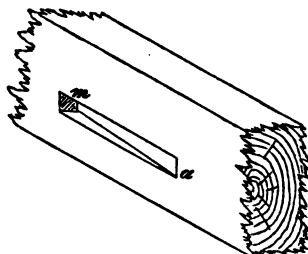

Fig. 170.

It may sometimes be necessary to make a vertical chase-

mortise in a horizontal beam. This should, however, be avoided if possible, as it cuts through so many fibres. The mortise should be parallel to the grain of the timber.

Circular Joints.—Circular joints, especially for very heavy frameworks, have been recommended by Tredgold, Robison, and other writers, but Dr. Young, in the *Encyclopædia Britannica*, maintains, that, even theoretically, they are not to be defended, and practically they are seldom, if ever, used.

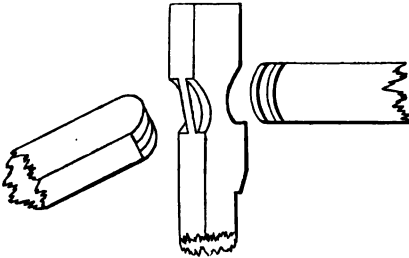

Fig. 171.

Fig. 171 shows the circular joints proposed by Tredgold for the head of a queen post with rafter and straining beam framed into it.

Bridle Joints are a sort of converse of the mortise and tenon. The simplest form, that for a post resting on a sill is shown in Fig. 172.

It will be seen that a kind of mortise is cut in the post to fit the bridle, or projection, *bb*, left upon the beam.

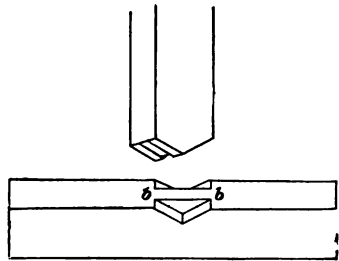

Fig. 172.

Figs. 173 174 show a bridle joint for the junction of the foot of a rafter with a tie beam. A similar joint may be used when the head of the rafter meets the king post. Such a joint, with the peculiarity of a circular abutment, is shown in Fig. 171.

The bridle joint is sometimes made use of in practice, and is strongly recommended, in all its forms, by Tredgold, on the ground that every part of it can be thoroughly seen into before it is put together, and can therefore be more easily fitted than the mortise and tenon.

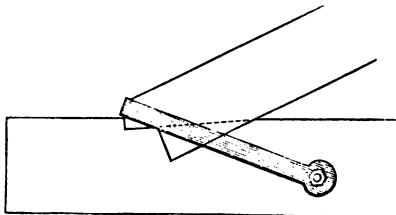

Fig. 173.

The width of the bridle should not, if possible, exceed $\frac{1}{5}$ of that of the beam, otherwise the cheeks, or pieces which fit on each

side of it, will be weak, and liable to be wrenched off by a slight lateral pressure.

Fig. 173 is the elevation of the foot of a principal rafter united to the tie beam by a bridle joint. Fig. 174 shows the timbers detached so as to make clear the construction of the joint. The joint in Fig. 173 is assisted by a heel strap, for a description of which see p. 79.

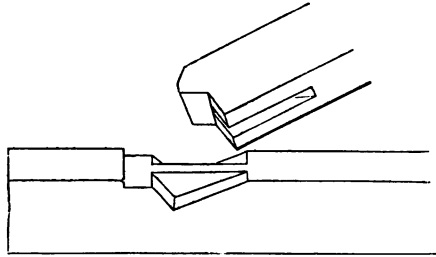

Fig. 174.

Post and Beam Joints.—A post, either upon or under a beam, may be kept in its place by a joggle, or stub tenon (as described at p. 68); but, as there is some danger of the shoulders of the tenon bearing unequally and thus reducing the strength of the post, the angular bridle joint (Fig. 172) is recommended by Tredgold as being more easily fitted.

It has been proposed that the lower end of the post should be formed with a circular abutment, but this has been proved by experiment to impair its strength.

When the beam meets the post at right angles to the side of its head, as in Fig. 175, a vertical tenon may be used, as shown.

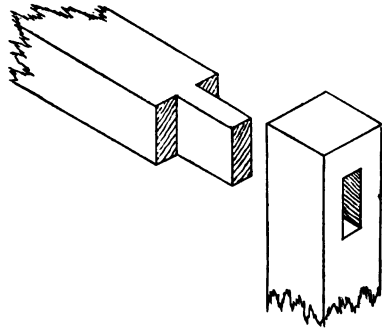

Fig. 175.

If the beam is at an inclination to the post, one of the several forms of oblique joint may be adopted (see p. 69).

Strut and Beam Joints.—In these it is only necessary that the pieces abut firmly, as long as there is no force tending to make them slide off laterally.

A plain mitre joint bisecting the angle, as at *a*, is preferable to any more complicated form, such as that at *b*,¹ which tends to produce unequal pressures, and to injure the timber.

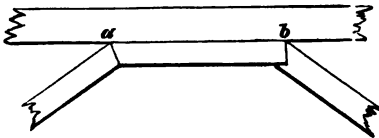

Fig. 176.

¹ The angular notch in the strut, into which *b* fits, is called a *birds-mouth*.

This form of joint is frequently rendered more secure by a cast-iron shoe formed to receive the ends of the timbers at the angle.

Tie and Brace Joints.—When two pieces of timber, meeting at an angle, are tied together, such as two rafters, united by a collar tie, or wall plates by an angle tie, it is very important that the joints between the ends of the tie and the other pieces should not draw out or yield in any way.

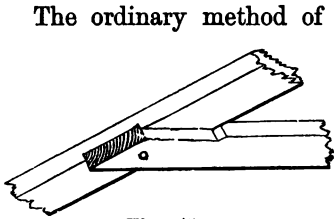

Fig. 177.

The ordinary method of forming such a joint is to cut out of the rafter or wall plate a notch of dovetail form, just sufficiently deep to afford a bearing for the tie to rest upon; a corresponding notch is made in the collar tie, and the joint is secured by a nail or pin driven through it.

The dovetail in this joint is objectionable, for the reasons already given (p. 63), and in order to avoid it, Tredgold recommended a joint similar in form to that shown in Fig. 154.

Suspending Pieces are used for supporting beams below them at one or more points. When adopted in a roof they hang from the point of junction of two rafters, and support the ends of the struts, as well as the tie beam.

The rafters generally abut against the head of the suspending piece, as shown in Figs. 167,

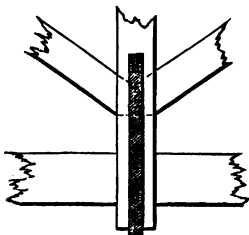
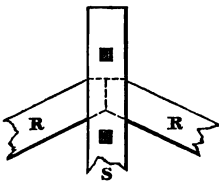

Fig. 178.

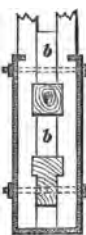

Fig. 179.

168, 169; but a better arrangement, in many cases, is to make the suspending piece in two thicknesses — the rafters being allowed to abut against one another, a thickness being placed on each side as shown in Figs. 178, 179. R R are the rafters butting against one another; s s the suspending pieces, notched upon the rafters, and bolted together through the blocks, b b.

The lower end of the suspending piece, supporting a pair of abutting struts and the centre of a tie beam, is shown in the same figures.

Wedging.—In order to keep a tenon tightly fixed, wedges are driven in, as shown in Fig. 180, between the tenon and the sides of the mortise.

The mortise should be slightly dovetail-shaped in plan, being wider on the side from which the wedges are inserted, in order to allow room for them to be driven in alongside of the tenon.

The wedges are of use in strengthening as well as tightening the joint, for they compress the fibres of the part cut through, and prevent them from yielding.

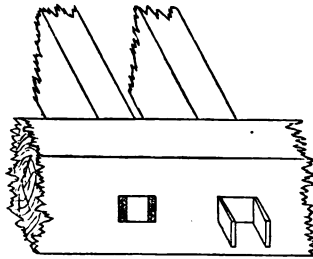

Fig. 180.

Wedges are generally sawn out of straight-grained wood, and are dipped in glue or white lead before they are inserted.

Wedges are used in pairs for tightening up joints (see p. 60), being driven inwards so as to take up more room, and thus to force the parts of the joint together. When they are so used, great care must be taken not to drive them too hard, so as to leave the joint with a violent strain upon it.

FOX WEDGING.—When a tenon is to be fastened into a mortise in a rail already fixed against a wall, or in any such position that the end of the tenon cannot be seen, it is secured by “fox wedges,” thus—

A wedge is inserted in a saw-cut in the end of the tenon, as

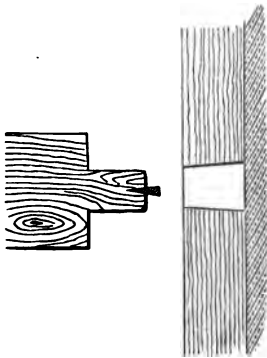

Fig. 181.

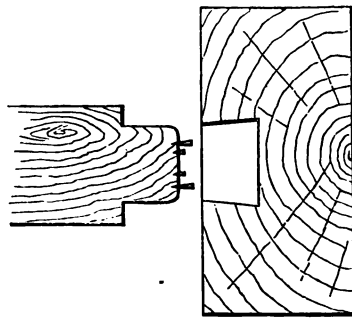

Fig. 182.

shown in Fig. 181. The mortise is made slightly wider at the back, and when the tenon is driven home, the wedge entering it splits and spreads out the wood, and makes it fill up the mortise.

With a single wedge there is some chance of splitting the tenon beyond the shoulder. This is thus avoided:—Four or more very thin wedges are inserted, as shown in Fig. 182, the two outer ones being longer than the inner ones. As the tenon is driven home, these in succession split off thin pieces, which easily bend, and therefore the splits do not extend too far. The wedges in the figure are rather short, but they should not be very long, as they would then be apt to be broken off in driving.

The enlargement of the back of the mortise should be a little less the total thickness of the wedges.

Keys are wedges of hard wood and curled grain inserted in a joint, and driven gently home, so as to force the parts into the position they will eventually occupy, before inserting bolts, etc. Without this precaution, there would often be a permanent and injurious strain on the latter.

In some cases keys also assist the joint in its resistance to the strain brought upon it (see Fig. 141).

They should be slightly dovetail-shaped in plan, and carefully driven, so as not to injure the fibres of the beam in which they are inserted.

The keys in scarfs should be $\frac{1}{3}$ the depth of the timber.

FASTENINGS.

Pinning is the insertion of a pin of hard wood or iron through the timbers forming a joint, to prevent them from separating, or through a tenon, to keep it from drawing out of the mortise. In the latter case, the pin may be through the mortised beam, as shown in Fig. 160, or, if the tenon protrudes beyond the beam, the pin may be outside, as in Fig. 159, care being taken to have a sufficient length of tenon beyond the pin to prevent the end being shorn off by the pin if any strain comes upon it.

Pins should be made from pieces of hard wood, *torn* off from the baulk, in order that they may be of uniform tenacity.

Square holes and pins are better than round ones, as they are less liable to split the wood.

DRAWBORING is an arrangement for keeping the shoulders of the tenon quite tight up to the cheeks of the mortise, and for tightening pinned joints generally.

The pin-hole is first bored through the cheeks of the mortise. The tenon is then inserted, and the position of the hole marked

upon it, after which it is withdrawn, and a hole bored in it a *little nearer the shoulder*. It is then again inserted, and an iron "draw-bore" pin forced in right through the holes, so as to bring the shoulder up as tight as possible. The drawbore pin is then removed, and the oak pin is inserted.

This operation is condemned by most writers, as it produces a constant and objectionable strain upon the pin and tenon; but it is nearly always resorted to in practice.

NAILS.—Different kinds of nails will be described in Part III.

They are used for roughly and strongly connecting pieces of timber of moderate size, for securing boarding to beams, etc.

SPIKES are large nails used for heavy work.

TRENAILS are pieces of hard wood used, like iron nails, for fastening boards to beams, for forming strong joints, etc., and occasionally, like pins, merely to secure joints formed in some other way.

They are useful in positions where iron nails would rust and injure the work, and where copper nails would be too expensive.

Trenails are generally of oak, cloven from the log, so that the longitudinal fibres may not be cut into.

They are from $\frac{3}{8}$ to $\frac{3}{4}$ inch in diameter, and from 3 to 6 inches long, according to the thickness of the pieces they unite, and slightly taper in form, to facilitate driving.

SCREWS.—The appearance of these is familiar to all, and need not be illustrated.

They are used in positions where the work is likely to be taken to pieces—for example, in fixing the beads of sash frames, which must be removed to repair the sash lines.

Screws are useful also in cases where driving a nail would split the wood, for fixing iron work, and for other purposes where security is required without jarring the joint.

Screws securing work likely to be removed should, if used in damp places, be of copper or brass, otherwise they will rust, and be difficult to withdraw.

Bolts are often used in order to give additional security to joints, some forms of which, indeed, depend upon them altogether for strength.

They have the disadvantage of weakening the beams through which they pass by cutting the fibres. If the timber shrinks, they become loose, and bruise the grain of the wood where they bear upon it.

Square bolts, with one side at right angles to the pressure upon

them, have been found by experiment to cut less into the timber than round bolts.

In many cases bolts are most useful, from the facility with which they can be tightened up, by means of a screw and nut, after the work in which they are used has taken its bearing.

One end of the bolt is generally formed into a solid head, and the other with a screw, on which is fixed a movable nut.

Another way of securing a bolt when it is likely to be removed is by a "slot," or oblong hole, in one of its ends, through which a key or wedge is driven.

The size of bolts should be calculated according to the strains upon them, and the quality of the iron used. Care should be taken that sufficient timber is left around them to prevent their tearing through in the direction of the strain.

"The following proportions will be found suitable for the bolts and nuts used in carpentry:"—

Diameter of head and nut, rose-square or hexagon, from	
side to side	$1\frac{1}{2}$ × diameter of bolt.
Thickness of head	$\frac{3}{4}$ × diameter of bolt.
Depth of nut	1 × diameter of bolt.

Hurst's *Tredgold*, p. 324.

The application of bolts to framing of different kinds is illustrated in Figs. 163, 220, and others.

WASHERS are flat discs of iron placed under the nut of the bolt to prevent it from pressing into and injuring the timber.

Size of washer—

For fir, $3\frac{1}{4}$ times diameter of bolt.

„ oak, $2\frac{1}{2}$ „ „

Rankine.

The thickness of washers should be equal to half that of the head of the bolt.

PLATES are also used to prevent the sharp corners of the nut from pressing into and injuring the timber, and further, in order to strengthen joints by fishing (see Fig. 143, and others).

Straps are often used, instead of bolts, to strengthen or form joints.

They have the great advantage of not cutting through and weakening the timber.

They are generally flat pieces of iron, about $1\frac{1}{2}$ to 2 inches in breadth, and with a thickness depending upon the quality of the iron and the strain upon them.

Straps should be fixed, as nearly as possible, so that the strain may come upon them in the direction of their length. Cross strains should be avoided as much as possible, but they are necessarily incurred by straps such as that shown in Fig. 169.

HEEL-STRAPS are used to secure the joints between inclined struts and horizontal beams, such as the joints between rafters and tie beams. They may be placed either so as merely to hold the beams close together at the joint (Fig. 183), or so as directly to resist the thrust of the inclined strut, and prevent it from shearing off the portion of the horizontal beam against which it presses (Fig. 230). Straps of the former kind are sometimes called *kicking straps*.

Fig. 183 shows a common form of strap for holding the foot of a rafter down to the tie beam. The screws and nuts on its extremities are prevented from sinking into the wood by the bearing plate B, and by them the strap may at any time be tightened up. A *check plate* is provided in Fig. 183 to prevent the strap from cutting into the under side of the tie beam, as in Fig. 186.

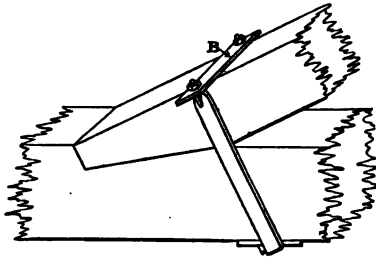

Fig. 183.

When there is no ceiling, and the strap is therefore visible, the ends of the bearing plate are often rounded, instead of being left square as shown in the figure. The bearing plate is sometimes placed below the tie beam, as in Fig. 186.

A somewhat similar form of strap is shown in Fig. 165. A bearing plate or bar is passed through the holes in the strap across the back of the rafter, and the strap is tightened by wedges driven into the holes.

The straps shown in Figs. 173, 258, are placed so as to take the thrust of the rafter, but are not capable of being tightened up. A bearing plate with screws and nuts may, however, be used with this form of strap, as shown in Fig. 230.

Straps of this description are sometimes placed so as to clip the rafter by a notch cut a few inches above the toe, so that they partially hold it down as well as resist its thrust (see Fig. 131).

STIRRUP is a name given to a strap which supports a beam, as in Figs. 228 and 178, and to heel-straps of the form shown in Fig. 173. Stirrups, such as that shown in Fig. 178, are sometimes formed with a bearing plate below the supported beam, and tightening screws similar in principle to those in Fig. 183.

Tredgold's rule for straps supporting beams—

If the longest unsupported part of the beam be				
10 feet,	strap should be 1 inch wide,	$\frac{2}{15}$	inch thick.	
15	"	"	$1\frac{1}{4}$	"
20	"	"	2	"

Straps which connect suspending pieces with beams may be formed with a slot, containing gibs and cotters, by which the joint may be tightened, as shown and explained at page 117.

When a strap embraces a built up beam, it may be welded into a rectangular hoop, and driven on from the end, the beam being slightly tapered to facilitate this; or, if that is inconvenient, it may be made as shown in Fig. 184, the ends passing through an iron head, and being secured by nuts.



Fig. 184.

BRANCHED STRAPS are frequently added to strengthen angle joints. They are subjected to cross strains when the framing settles.

Several forms of these are given (see Figs. 168, 169, 221, 228).

Cast-iron Shoes, Sockets, etc., are frequently used to protect the ends of beams from damp or fire (see Fig. 197), and also in themselves to form a joint between two beams.

TIE-BEAM PLATES.—These may be made of various forms (see Figs. 185,¹ 186, and also Fig. 235). While the plate protects the beam from the damp of the wall, it also forms a corbel to support it, and the upper part may be shaped so as to secure the pole plate above.

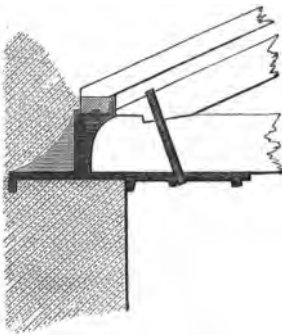

Fig. 185.

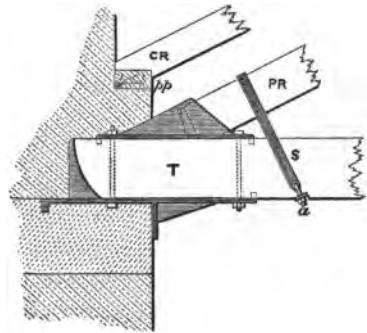

Fig. 186.

SHOE FOR FOOT OF RAFTER.—The foot of a strut or rafter may be received by a shoe instead of being tenoned into the beam (see Fig. 186). The strap shown in this figure is hardly necessary, as the end of the rafter is held down by the shoe.

¹ Taken from an illustration of a roof in Newland's *Carpenters' and Joiners' Assistant*.

Fig. 187 shows another form of shoe for a rafter when a tie-rod is used.

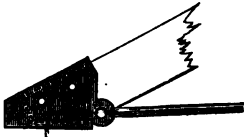

Fig. 187.

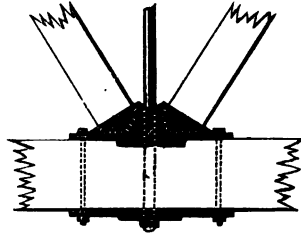

Fig. 188.

DOUBLE SHOE TO RECEIVE A PAIR OF STRUTS.—Fig. 188 shows a cast-iron shoe adapted to receive a pair of struts in a framing, such as that of the roof shown in Fig. 235.

SOCKET PIECES.—Sometimes the tenons at the head of rafters, or the heads themselves, are received in a cast-iron socket piece, as in Fig. 189 (see also Fig. 231 and Fig. 233).

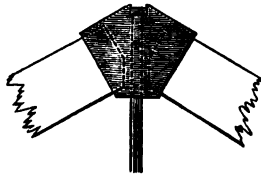

Fig. 189.

CHAPTER V.

CARPENTRY—(Continued).

FLOORS.

WOODEN floors consist of boards supported by timbers. The timbers of floors of upper rooms frequently have to carry a ceiling for the room below, which has therefore to be considered in the construction of the floor.

Naked Flooring is the term applied to the timbers of the floor without the boards.

Classification of Floors.—There are three classes of floors, viz.
 Single floors.
 Double „
 Framed „

In all these floors the boards rest immediately upon pieces of timber called “*bridging joists*” or “*common joists*.”

N.B.—In the sketches illustrating the subject of *Floors* (Figs. 190 to 218) the parts are marked with the distinctive letters given below.

Binders	B.	Plastering	P.
Boarding	b.	Pugging	p.
Bridging joists	bj.	Strutting	s.
Ceiling joists	cj.	Templates	tp.
Fillets for sound boards	f.	Trimmers	T.
Firings	F.	Trimming joists	tj.
Girders	G.	Wall plates	wp.
Lathing	l.		

Single Floors.—In single floors the “*common*” or “*bridging joists*” span the whole distance from wall to wall, and rest upon the wall plates or templates only.

With a given quantity of timber single floors are the strongest, cheapest, and simplest; they distribute their weight and load very equally over the walls upon which they rest, and hold the sides of the building together.

The disadvantages of single floors are—

1. When they are used for a span of more than 12 or 15 feet¹

¹ Tredgold says that to ensure stiff ceilings the bearing of single floors should not exceed 12 feet, but they are frequently made with a bearing of 18 feet or even more.

the bridging joists (unless of considerable size) are liable to bend or "sag," and thus to crack the ceiling (if any) below.

2. They require a good deal of "trimming" to avoid resting the ends of the joists on flues, fireplaces, etc. (see p. 90).

3. The joists bear equally on all parts of the walls, on piers and openings alike, and thus the jars upon the floor are communicated to the wall even at its weak points.

4. They necessitate the use of wall plates, which often have to be fixed in the wall (Fig. 200), and are then objectionable.

5. They facilitate the passage of sound from the room below.

This last defect can be remedied or removed by "pugging" (see p. 91), and also by keeping nearly all the bridging joists clear of the ceiling, so as to have as few conductors for the sound as possible (see Fig. 202). This latter is, however, an expensive arrangement, as it renders ceiling joists necessary.

In ground floors of large span, intermediate walls ("dwarf" or "sleeper" walls) or piers are built to support the joists at intervals.

Figs. 190, 191, 192 give a plan and sections of a single floor. In this case there are no ceiling joists, the laths being nailed to the under side of the bridging joists, which are all of the same depth.

Fig. 190.

Plan. Scale $\frac{1}{8}$ "

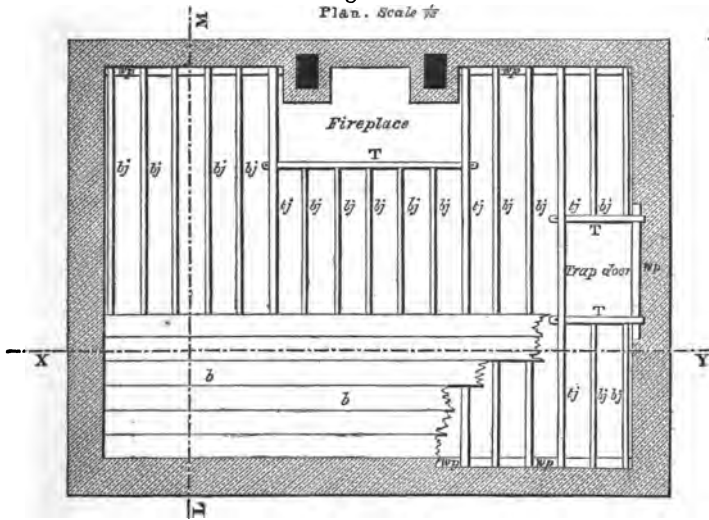

Fig. 192.

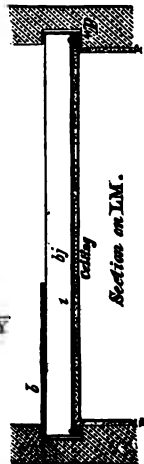

Fig. 191.

The floor in this example is trimmed across the joists in order to keep them clear of the fireplace, and on the right side of the room to leave space for a trap door.

Most of the boarding is omitted in order to show the joists.

Fig. 202, p. 90, is the section of part of a single floor with ceiling joists, which are supported by the deep joists at the ends of the figure. Only one joist in every four or five is thus connected with the ceiling joists, in order to obtain a more rigid ceiling, and also that the points at which the sound can be conducted through the floor may be as few as possible.

Double Floors. — In these the *bridging joists*, instead of spanning the whole distance from wall to wall, are supported by intermediate balks called *Binders* (or "*Binding Joists*"), BB, Fig. 193.

The stiffness of these floors prevents deflection, and secures the ceiling from cracking. They stop the passage of sound from the room below, and the massive binders are of great assistance to the walls of the building in tying them together. Moreover, if binders are placed close to the walls to carry the ends of the joists instead of wall plates, all timber may be kept out of the masonry except the ends of the said binders themselves.

Double floors are, however, in many ways of a complicated and bad form of construction. The bridging joists, instead of being merely supporters, are burdens upon the binding joists, and these in their turn transfer the whole weight of the floor and its load to a few points on the walls, instead of distributing the pressure.

If, however, the wall is weak, and full of openings, this may be an advantage, as the binders may be carefully arranged so that their ends fall upon the stronger portions of the wall, leaving the weaker parts unloaded.

The space between two binders is called a "*Case Bay*," and that between the binder and wall a "*Tail Bay*."

Tredgold recommends that binders should be fixed from 4 to 6 feet apart, not more than 6 feet. They should be placed so that they may rest on the piers between the windows, not over the openings; they bear either upon wall plates running the whole length of the wall, or upon stone templates of a sufficient length to distribute the pressure.

A plan and sections of a double floor are shown in Figs. 193, 194, 195.

The binders rest on stone templates, *tp*; and the trimming of the joists to clear a flue in the wall is shown at A.

The method in which the floor is finished, with an oak border round the hearthstone, is also shown. A similar border is shown in section in Fig. 204. It is sometimes made, for economy, thinner than the floor boarding, which is checked out to receive it.

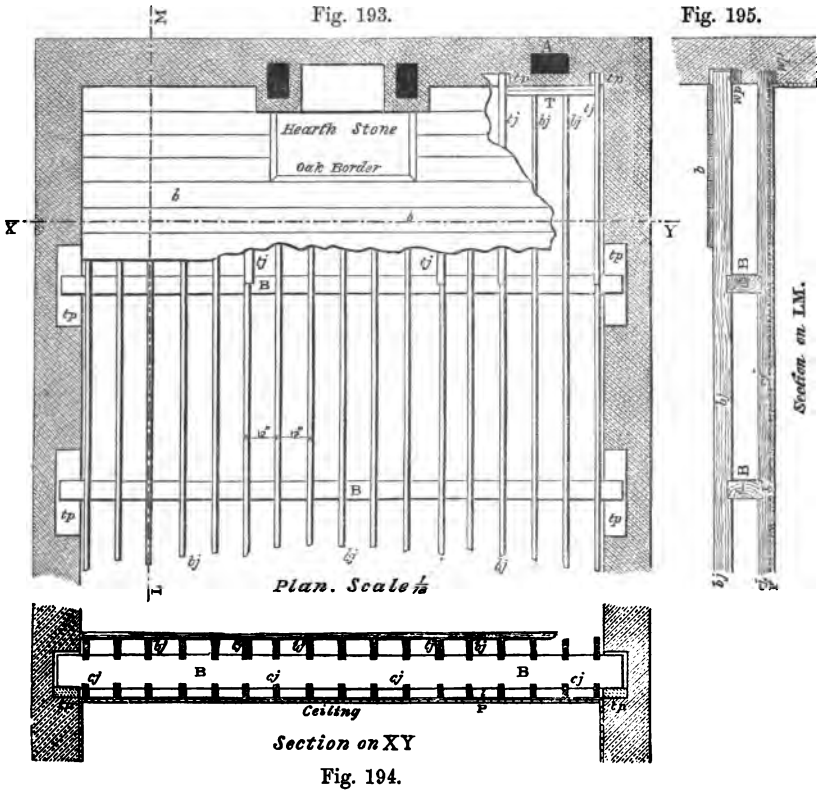

Fig. 194.

The ceiling joists are omitted in plan to avoid confusion. It will be understood that they are attached to the under side of the binders, as shown in section, and run at right angles to their direction.

Framed Floors.—The *bridging joists* in these floors also rest immediately on *Binders*, but the latter, in their turn, are supported by larger balks or "*Girders*."

Framed floors possess, in a still greater degree, the advantages and disadvantages attributed above to Double Floors.

The girders may be of any form or material selected after duly considering all the requirements of the case. (See Part III.)

If the girders are simple balks of timber, the binders are framed into them by double tusk tenons. They should be kept as far as possible from the centre of the length of the girders, in order not to weaken them at the points where the strain is the greatest.

The girders and binders should be as deep as possible, so that the floor may be stiff, not liable to shake or crack the ceiling below. Tredgold recommends that the distance apart of the girders should not exceed 10 feet; their position depends, however, on the plan of the building.

Figs. 196, 197 represent a framed floor in plan and section.

Fig. 196.

Plan. Scale $\frac{1}{16}$

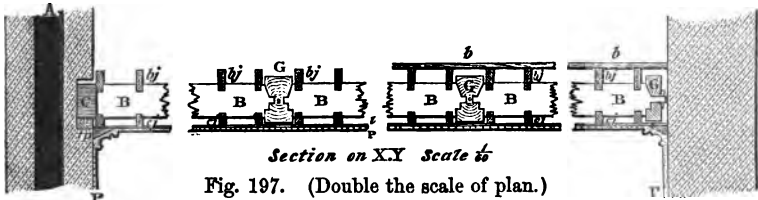
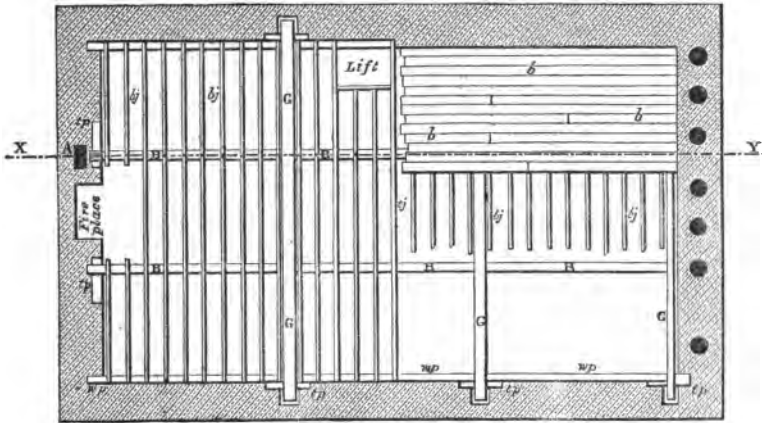

Fig. 197. (Double the scale of plan.)

N.B.—In Fig. 197 the graining of the binders shown in section is omitted for the sake of clearness.

The girders rest upon stone templates, and the binders are framed into them as above described. The end of one of the binders, which is close to a flue in the wall at A, is protected against fire by a cast-iron shoe C.

Another way of effecting this would be to allow the end of the binder to rest upon a corbel projecting from the wall.

One end of the floor is supported by a half-girder, in order that

it may not rest upon the wall containing flues ; if it were not for these the ends of the binders would rest upon the wall. On the upper side is shown the trimming necessary for a lift.

A great portion of the boarding is broken away to show the timbers below, and the ceiling joists are, as before, omitted in plan to avoid confusion.

When binders are tenoned into a girder they cut into and weaken it considerably, especially when, as is generally the case, the binders

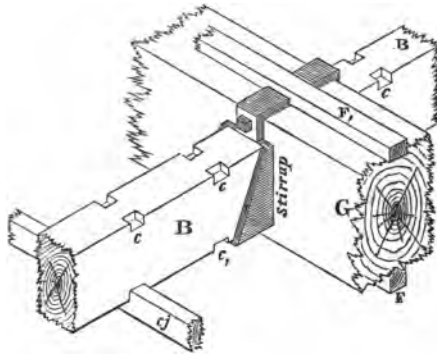

Fig. 198.

are opposite to one another ; to avoid this, iron *stirrups* (Fig. 198) are often used to carry the ends of the binders, and so to leave the girder intact.

In framed floors, especially in Scotland,¹ the binders are sometimes omitted, the girders are of slighter scantling, and put closer together, and the bridging joists either notched on to them (if the space will permit), or, if otherwise, tenoned into them. The ceiling joists are suspended by straps of wood (see Fig. 218, p. 100).

This makes a strong, stiff, and economical floor, but if the bridging joists are simply notched (as they should be) it occupies a considerable depth.

Timber Girders.—*General Remarks*, applying only to plain beams. Built up, Fitch, and Trussed girders will be considered in Part II.

Girders should always be placed so as to have good supports for their extremities.

Those intended to support floors should rest, therefore, on solid walls or piers, not over the windows or other openings.

To ensure this, it is sometimes necessary to lay them obliquely

¹ Newland's *Practical Carpenter's and Joiner's Assistant*.

across the room, but an inclined position should be avoided if possible. It is better to provide very strong templates over the openings to carry the girder and throw the weight well upon the piers.

The ends of all timber girders should rest upon stone templates, and be perfectly clear of the masonry.

Girders should be weakened as little as possible by mortises or joints of any kind which cut into them, especially at or near the centre of their length, where the greatest strain comes upon them.

Wall Plates are pieces of timber built into or upon a wall to support the ends of joists or other bearers.

They distribute the weight thrown upon them by the joists, and give the latter a hold upon the side walls, so that these are tied together.

On the ground floor the wall plates generally rest upon an offset in the wall, as in Fig. 199.

Above also they may rest on an offset if there is a change in the thickness of the wall; or,

They may be built into the wall, as shown in Fig. 200, great care being taken that there is a free circulation of air round the end of the joists; or,

They may rest on *corbels* provided for the purpose, as in Fig. 201, thus preventing all danger of decay by contact with the masonry and want of air.

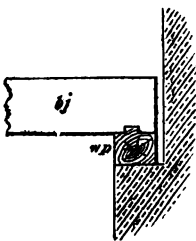

Fig. 199.

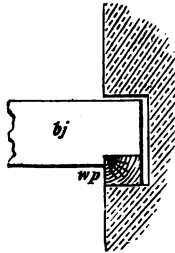

Fig. 200.

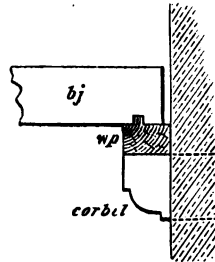

Fig. 201.

The joists are either simply nailed on to the wall plates, or "notched" (Fig. 200) or "cogged" (Fig. 201) upon them.

If the joists are of unequal depths, the notches are varied in depth also, so as to keep the upper surfaces of the joists in the same plane.

Cogging gives the joists a good hold upon the wall plates, so as to tie the walls in, but it is seldom done.

Wall plates are sometimes dovetailed into each other where

they meet at the angles of a building, but there are great objections to dovetails (see p. 62), and it is better that they should be halved and bolted.

Wall plates should be in as long pieces as possible, and when two or more pieces are required to extend along the length of the wall they should be carefully scarfed together (p. 62).

Tredgold's Rule for size of Wall Plates—

For a 20 feet bearing, $4\frac{1}{2}$ inches by 3 inches.

30 " " 6 " " 4 "

40 " " $7\frac{1}{2}$ " " 5 "

Templates.—Stone templates are often used instead of wall plates, and have the great advantage of being indestructible by fire or decay. The joists cannot, however, be economically fixed to them, which is a disadvantage.

They should be of hard stone, and in lengths of at least 2 or 3 feet, so as to distribute the weight of the joist and its load over a wide bearing.

Bridging Joists or "Common Joists."—These are generally laid about 12 inches apart from centre to centre, or sufficiently near to prevent the deflection of the floor boards.

With the same quantity of timber, the deeper the joists can be made the stiffer and stronger they are. The depth can be calculated by the rules given in Part III., or obtained from the table, page 101.

It must, however, be remembered that an increase in the depth of the joists necessitates an additional height of walling in the building, and causes expense.

Joists should not be less than 2 inches wide, or they will be split by the nails holding the boarding, especially at the heading joints where four nails come together. In a *trenailed* floor (see p. 76) the joists should be wider. They should never be more than 3 inches wide if they are themselves to carry a ceiling (without the intervention of ceiling joists), as the lower surface of the joists causes a blank space behind the ends of the laths, which interrupts the key for the plastering.

Joists are nailed, cogged, or notched on to the wall plates as detailed in page 88.

General remarks on fixing joists and other bearing timbers will be found in Part III.

Strutting.—Joists more than 10 feet long should be *strutted* at intervals of about 7 feet, to make them stiff and to prevent them from turning over sideways. The struts also add greatly

to the strength of the floor, by causing the pressure on the joists to be transmitted from one to the other.

HERRING-BONE STRUTTING¹ consists of small pieces from 2 inches to 3 inches wide and 1 inch thick inserted diagonally and crossing one another between the joists, as shown at *ss* in Fig. 202. They must not be split in nailing them; the holes for the nails must be bored; or two small saw cuts made in each end of the struts to receive them.

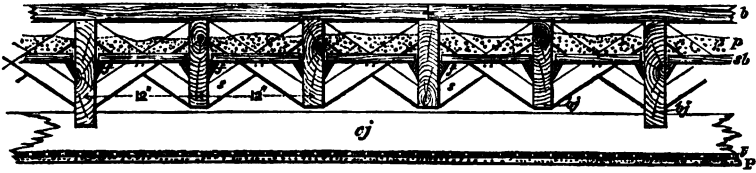

Fig. 202. (Scale $\frac{1}{16}$.)

Sometimes simple pieces of board at right angles to the joists, and fitting in between them, are used instead of the herring-bone strutting.

KEY STRUTTING.—Wooden keys are occasionally used instead of struts. They are mortised through the joists with very small tenons, which must, however, weaken the joints to a certain extent, and they are therefore objectionable as well as being expensive.

Of the above forms the herring-bone struts are the best, as they do not cut into the joists, and they transmit the pressures upon them in proper directions.

All strutting, to be really effective, should be in straight lines along the floor, so that each strut may abut directly upon those adjacent to it.

Tension rods are sometimes passed through the joists at right angles to their length so as to bind them together, compressing the struts; this adds greatly to the stiffness of the floor.

Pugging² is plaster (coarse stuff) or other mixtures laid upon boards fitted in between the joists of a floor to prevent the passage of sound or smell from the room below.

The "*sound boarding*"³ *sb* (see Fig. 202) to carry the pugging, *pp*, is supported on fillets, *f*, nailed along the sides of the bridging joists, *bj*, about half-way down.

The fillets are sometimes rectangular in section, about 1 inch

¹ Sc. *Dwangs*.

² Sc. *Deafening*.

³ Sc. *Deafening-boarding*, or sometimes *Pug-boarding*.

by $1\frac{1}{4}$ inch, but are better if cut diagonally out of a piece 2 inches by $1\frac{1}{4}$ inch (see Fig. 202), as they then have a larger surface for nailing.

Dry Moss — or a mixture of lime mortar, earth, and smith's ashes — are sometimes used instead of the plaster.

Slips of cork or list along the upper edges of the joists upon which the boards are nailed, are recommended by Tredgold as a means for reducing the passage of sound. Felt or felt-paper over the boards and under the carpet have been used for the same purpose.

Trimming.¹—It often happens that on account of flues, fireplaces, or from other causes, it is inadvisable to let the ends of the joists rest on particular parts of the walls, and it is necessary that they should be *trimmed*.

The arrangement of the trimming varies according as the joists are at right angles to or parallel to the wall in which the flue or fireplace occurs.

In the former case (see Fig. 204) the joists are stopped short of the portion of wall to be avoided, and tusk-tenoned into a cross beam T, called a *trimmer*.

This trimmer is tusk-tenoned at the ends, and framed in between the two nearest bridging joists bearing on the wall, on each side of the portion to be avoided.

The joists, *tj*, carrying the trimmer are called "*trimming joists*." As they have to carry more weight than the other bridging joists, they are made wider.

Tredgold's Rule.—To the width of the common joists add $\frac{1}{4}$ of an inch for every joist carried by the trimmer, and that will give the width of the *trimming joists*. The *trimmer* should be calculated by the same rules as *binders* (see p. 102). This rule refers to the ordinary case in which the joists are all of the same depth, as in Fig. 191. When the trimming joists are deeper than the others, they need not be so wide in proportion.

Figs. 203, 204 show five joists trimmed to avoid a fireplace. A small "*trimmer arch*"² is turned from the wall to the trimmer to carry the hearthstone. The length of this arch may with advantage be equal to the full width of the chimney breast, and it should, in any case, be at least 27 inches longer than the width of the opening of the fireplace, so as to support the hearthstone, which is 18 inches longer than the width of the opening, and to leave room besides for a cradling piece $4\frac{1}{2}$ inches wide at each end, to support the oak border and the ends of the floor boards.

¹ Sc. *Bridling*.

² Sc. *Bridle*.

When the arch is so formed as to extend past the crown before it reaches the trimmer, a fillet is sometimes fixed on the latter to form a skewback.

In some cases a filling-in piece is fixed between the trimmer and the wall to support the ceiling joists under the arch. This construction is, for some reasons, objectionable, for it requires a corbel or plate in the wall to support the end of the filling-in

Fig. 203.

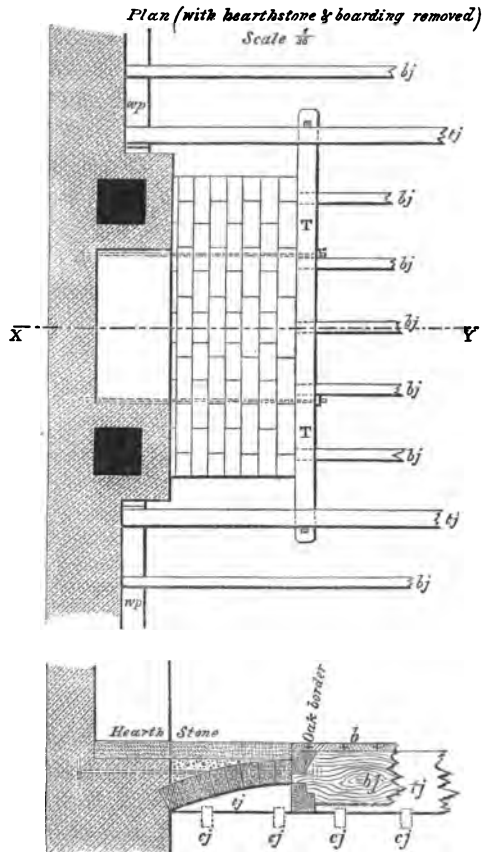

Fig. 204. Section on X Y.

N.B.—The ceiling joists are omitted in plan to prevent confusion.

piece; and in the illustration given (Fig. 204), it is also unnecessary, for the ceiling joists can be fixed to the trimming joists as shown, and require no support between them. If, however,

there are no ceiling joists the filling-in pieces are necessary to support the laths for the plaster of the ceiling.

When the joists are parallel to the wall in which a fireplace occurs, the trimmer arch is turned against the first continuous joist (in this case called the "trimming joist"), and short trimmers are inserted to carry the trimmed joists between that joist and the wall, in the same way as shown in the trimming for the trap-door in Fig. 190.

A layer of 3 or 4 inches of Portland cement concrete is sometimes used instead of the trimmer arch. Curved tiles have also been used for the same purpose.

The thrust of the trimmer arch is sometimes counteracted by iron rods built into the wall, as shown in dotted lines. They are more useful when the joists are parallel to the fireplace, in which case the trimming joist against which the arch abuts requires support against bending laterally; the rods, however, are seldom used.

Fig. 193 shows two joists trimmed to avoid the flue at A.

In Fig. 190 is shown the trimming necessary for a trap-door in the floor, and in Fig. 196 a trimming for a lift.

Openings for stairs are trimmed in a similar manner (see Part II.)

Floor Boards are laid in several different ways.

*Plain jointed.*¹—The boards are simply laid side by side, as close as possible (see Fig. 205), a nail or generally two being driven through the boards into each joist.

The inevitable shrinkage of the boards, as at A, will cause openings through this description of floor.

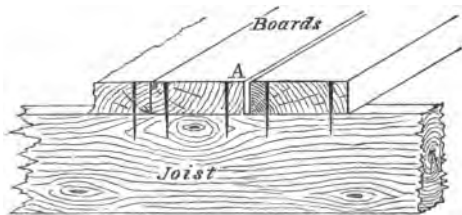

Fig. 205.

*Rebated,*² of which the section, Fig. 206, explains itself.—Here a considerable shrinkage may take place, as at A, without causing an opening between the boards throughout their depth.

¹ When two boards simply abut against one another, their edges may be "shot" or smoothed off with a plane, and their junction is known as a plain or *butt joint*.

² *Rebating* or *Rabbeting* is the cutting a rectangular slip out of the side of a piece of wood, as at A in Fig. 206. The re-entering angle left upon the wood is called the *rebate* or *rabbet*, or Sc. *the check*.

*Fillistered*¹ is another name for the joint shown in Fig. 206.

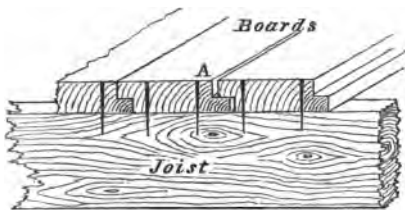

Fig. 206.

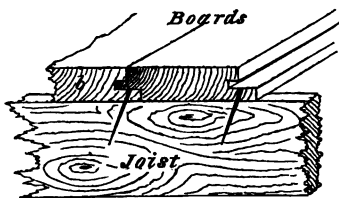

Fig. 207.

*Rebated, Grooved,*² *and Tongued.*—One board can first be nailed as shown at *b*, Fig. 207, and then the other board, upon being slipped into it, will be kept down by the form of joint. Thus the nails are prevented from appearing on the surface of the floor, which is sometimes desirable.

Rebated and Filleted.—A rectangular *rebate* is cut out along the lower edges of the boards, as in Fig. 208, and the space filled in with a slip or "*fillet*," occasionally of oak or some hard wood.

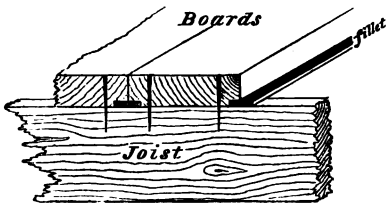

Fig. 208.

It will be seen that any opening caused by shrinkage is covered by the fillet, and the floor must be worn down nearly

through its whole thickness before the fillet is exposed.

Ploughed and Tongued.—A narrow groove is cut in the side of each board, and an iron or wooden³ tongue inserted.

It will be noticed that this shares some of the advantages of the filleted joint, but the tongue is sooner laid bare when the floor is much worn. The tongue should be kept lower than the

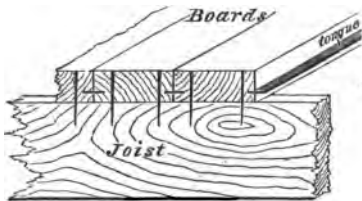

Fig. 209.

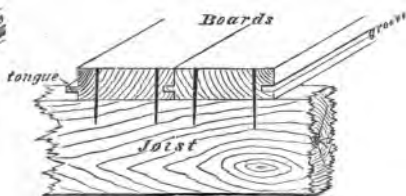

Fig. 210.

centre of the thickness of the boards, so that as much wear as possible may be got out of them before it is exposed.

¹ Another meaning of the word *fillistered* is given at p. 97.

² *Grooving* or *Ploughing* is the formation of a rectangular groove in a piece of wood to receive a tongue, as in Figs. 209, 210.

³ See remarks on slip feathers, page 168.

*Grooved and Tongued.*²—In this joint (Fig. 210) the tongue is worked upon one board to fit the groove cut in the other. This is not an improvement on the joint last described; the tongue is necessarily thicker, and thus causes a thinner piece of wood to be left above the groove. This rots and flakes away if the floor is often washed.

Dowelled.—Small oak dowels are fixed along the edge of one board to fit into holes in the other (see Fig. 211).

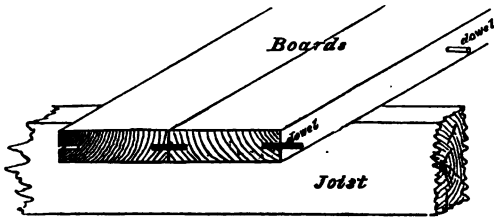

Fig. 211.

The dowels should not be over the joists, but in the spaces between them, so that the edges of the boards are held down and kept flush, at short intervals throughout their length, by the nails at the joists, and by the dowels between.

Dowelled floors show no nails on the surface; only one edge of each board is nailed obliquely, the other being kept down by the dowel.

Of the joints above described, those illustrated in Figs. 205, 206 are used chiefly for inferior floors; that shown in Fig. 208 for warehouses or barracks; those in Figs. 209, 210 for ordinary floors of a high class; and that in Fig. 211 for very superior floors.

The joints in Figs. 206, 207, 210, necessitate the use of a larger quantity of boarding to cover a given surface than when the other joints are adopted.

HEADINGS.—The boards in floors are seldom long enough to go right across the room.

In such a case the joint between the end of one board and the next is called the *heading joint*.

Headings should always fall upon joists, and break joint with one another in plan.

Square Heading.—In this the ends of the boards simply butt against one another, similarly to the side joints in Fig. 205.

Splayed or Bevelled Heading.—The ends of the boards are splayed to fit one another, as shown in Fig. 212.

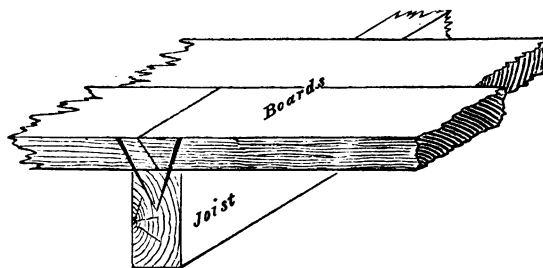

Fig. 212.

Tongued Heading.—The ends of the boards are cross-grooved, and laid with a cross-grain wood, or a metal tongue, similar to that shown for the side joints in Fig. 209.

Rebated and Tongued Heading is formed in the same way exactly as the joint shown in Fig. 207, and has the advantages mentioned at page 94.

Forked Headings.—In these the ends of the boards are cut into a number of sharp salient and re-entering notches, whose ridges are parallel to the surface of the floor. These notches fit one another, and form a tight joint.

Such joints are sometimes used in oak floors, but they are extremely troublesome and expensive to make, and the point nearest the surface of the floor is very liable to break away, even in hard wood.

BROKEN JOINT FLOORS.—Sometimes in very common work the boards are not all gauged to one width, so that there are breaks in the longitudinal joints. This occurs chiefly when the floor is laid "folded," as described on page 97.

STRAIGHT JOINT FLOORS.—The usual practice is, however, to have the floor boards gauged to the same width, so that their longitudinal joints form straight lines from end to end.

GENERAL REMARKS ON FLOOR BOARDS.—Floor boards should be brought on to the ground prepared and planed, generally by machinery, as early as possible after the building is commenced, so that they may be thoroughly seasoned before they are required to be laid.

If not prepared by machinery, the boards should all be brought to the same width, have their edges shot, and be gauged to the same thickness with a fillister plane, which takes out a rebate on each

side down to the gauge mark.¹ They are then turned over, and trimmed down to the proper thickness at the points where they cross the joists.

The best floors are those laid with narrow boards (from batten widths down to strips of 3 inches or 4 inches wide), as the shrinkage in each is less, and the joints can be kept tighter.

The boards may with advantage be placed in position, and left a year thoroughly to season before being nailed down.

However well seasoned they may be, they will always curl up a little after being touched with the plane.

Folded Floors.—Floor boards are generally jammed tightly together as they are laid, by means of flooring cramps, but in common floors they are sometimes *laid folding*, thus:—

Two boards are laid and nailed at a distance apart little less than the width of 3 or 4 boards. These are then put into the space, and forced home by laying a plank upon them, and jumping upon it (see Fig. 213).

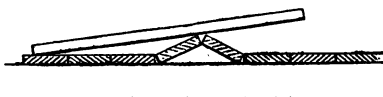

Fig. 213.

The boards thus laid together are often of the same length, so that their heading joints fall into one line, and are not properly broken.

Floor Boards in Two Thicknesses.—In very superior floors two layers of boards are frequently used. The lower layer consists of rough $\frac{3}{4}$ inch deals nailed on to the joists in the usual way. When it is down, the grounds, joinery, skirtings, etc., are fixed, and the plastering completed. After which, the upper layer, consisting of narrow strips 1 or $1\frac{1}{4}$ inch thick, is fixed with dowelled or other secret-nailed joints.

Nailing Floor Boards.—The position of the nails, in the various forms of joint, are shown in the figures.

Flooring brads are generally used for securing the boards to the joists; they are flat-sided nails, which are easily driven in parallel to the grain of the boards without danger of splitting the wood.

Occasionally, especially in oak floors, screws are made use of, and the holes for them countersunk, so that their heads are below the surface of the floor, which can, therefore, be planed.

When the heads of the nails are concealed, as in Fig. 207, the

¹ This operation is called *fillistering*.

floor is said to be "*secret-nailed*." This may be effected in the joints shown in Figs. 209, 210, by driving the nail obliquely through the edges of the boards, taking care to clear the tongue or feather.

Secret-nailing is sometimes advisable for polished oak floors, or when the boards are very narrow, as, in the latter case, there would otherwise be a great many nail-heads in the surface.

General Remarks on Floors.—The timbers that carry the weight should, as a rule, be laid the narrowest way of the room.

The bearing timbers may be so arranged as to tie in the principal walls, or, if the building forms a corner, having two or more external walls, they may be laid in opposite directions in the alternate stories.

All parts of timber built into walls should have clear spaces round them for circulation of air.

Timbers passing over several points of support, such as joists over binders, joists or binders over party walls, and similar cases, should be in as long lengths as possible, by which their strength is greatly increased as compared to what it would be if they were cut into short lengths, just sufficient to span the intervals between each pair of supports. (See Part III.)

Fixing uniformly loaded timbers rigidly at the ends increases their strength by one half, but this can seldom be done in practice. If the ends are built into the wall they have a tendency to strain and destroy the masonry. The want of a free circulation of air causes the timber to decay, and in any case it soon shrinks and becomes loose.

Tredgold recommends that floors should be laid with a slight rise in the centre (about $\frac{3}{4}$ inch in 20 feet), to compensate for the settlement that will take place in the beams.

All floors near the ground should be ventilated, to secure a perfect circulation of air round all their parts. This is easily done by inserting air bricks in the walls.

For the same purpose openings should be left in the sleeper walls carrying the intermediate wall plates of ground floors.

The ground below the floor should be thoroughly drained, and covered with ashes and quicklime. It is sometimes asphalted all over to prevent damp from rising.

PARQUET FLOORS have their surface formed with small pieces

of wood, inlaid to a pattern. They are more the work of a cabinetmaker than of a carpenter, and do not come within the scope of these Notes.

FLOORS OF SHORT TIMBERS.—These consist of very short pieces arranged in different ways so as to support one another, but a description of them would be more curious than useful.

Ceiling Joists¹ are light beams to carry the laths for the plastering of the ceiling. They are fixed to the under side of the bearers of the floor, running at right angles to them; that is, in a Single floor to the bridging joists, in a Double or Framed floor to the binding joists.

They should be 12 inches from centre to centre; if more widely placed than this, the laths are likely to give with the weight of the plaster.

Two inches is the best width for ceiling joists. This is sufficient to nail the laths to. If wider, the under surface of the joist interrupts the key for the plaster.

Notched.—The mode of fixing ceiling joists is generally to notch them and nail them, as shown in Fig. 195.

Chase-mortised.—Sometimes, however, the depth from the ceiling to the surface of floor has to be kept as small as possible, in order to gain space. With this object the ceiling joists may be tenoned in between the bridging joists or binders with chase mortises, formed either as at *x* or as at *y*, Fig. 214. This should, however, be avoided as much as possible, for the mortises weaken the bearers.

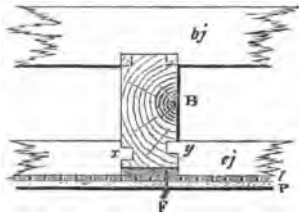

Fig. 214.

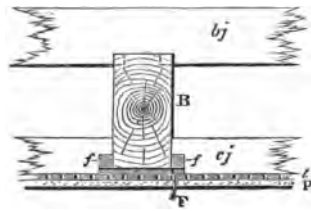

Fig. 215.

Filleted.—Another plan is to support the ends of the ceiling joists, *ff*, upon fillets nailed to the bridging joists, as shown in Fig. 215.

Where ceiling joists are fixed in between bearers, their lower

¹ Sometimes called *Raglins* in the north of England.

edges are allowed to come a little below the latter, a *furring*¹ (F in Figs.) not wider than the ceiling joist being attached to the bearer below, so as to afford a key for the plaster.



Fig. 216.

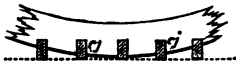

Fig. 217.

This is advisable also, because the bearers are sure to sag, and if the under sides of the ceiling joists were flush with those of the bearers, the ceiling would be curved as in Fig. 216 (the curve in which is of course exaggerated): but by allowing them to be lower, they can be so arranged (see Fig. 217), that, after the bearer has sagged, their lower surfaces

may be in a horizontal plane, so as to form a level ceiling.

In single floors with ceiling joists every fifth or sixth bridging joist is generally made 2 inches or so deeper than the others, and extends below them to carry the ceiling joists (see Fig. 202).

This, as already explained, is to prevent the passage of sound, by reducing the number of points at which it is conducted through the wood.

Ceiling joists should be fixed slightly higher in the centre of the room (about $\frac{3}{4}$ inch in 20 feet), to allow for the inevitable settlement of the floor.

In single floors of small span, the ceiling joists are frequently altogether dispensed with, and the laths nailed to the underside of the bridging joists (see section, Fig. 191).

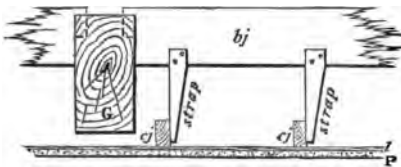

Fig. 218.

Ceiling joists are sometimes hung from the bridging joists in a framed floor—such as that mentioned at page 87—by wooden straps, as in Fig. 218. Thus the separation between the floor and ceiling is more

complete, and the sound is less readily conducted.

BRANDERING.—The ceiling joists to which the laths are nailed somewhat interrupt the key for the plastering of the ceiling. To remedy this, and to obtain a stiffer ceiling, battens about 1 inch square, and from 12 to 14 inches apart, are sometimes nailed to the under side of the joists, crossing them at right angles. These

¹ *Firrings* or *Furrings* are small rough pieces of wood attached to any piece of carpentry to bring its surface up to a required level. Sc. *Ekings*.

battens keep the laths at a little distance from the joists, and thus give room for the plaster to be squeezed in behind them and form a "key."

Sizes for Floor Timbers.—TABLES OF SCANTLING.

Table of the SCANTLINGS recommended by Tredgold for SINGLE or BRIDGING JOISTS of Baltic pine for different bearings from 5 to 25 feet—the distance from centre to centre of the joists being 12 inches.

Length of Bearing in Feet.	Breadth, 1½ in.	Breadth, 2 in.	Breadth, 2½ in.	Breadth, 3 in.	Breadth, 4 in.
	Depth in inches.	Depth in inches.	Depth in inches.	Depth in inches.	Depth in inches.
5	5½	5½	4¾	4¾	4
6	6½	5¾	5¾	5	4½
8	7½	7	6½	6½	5½
10	9	8	7½	7	6½
12	10	9½	8½	8	7½
14	11	10	9½	9	8
16	12½	11	10½	9½	8½
18	13½	12	11½	10½	9½
20	14½	13	12	11½	10½
22	15	13½	12½	12	11
24	16	14½	13½	12½	11½
25	16½	15	14	13	12

Table of SCANTLINGS recommended by Tredgold for BINDING JOISTS of Baltic pine for different spans from 5 to 20 feet, when the distance from centre to centre is 6 feet.

Length of Bearing in Feet.	Depth, 6 in.	Depth, 7 in.	Depth, 8 in.	Depth, 9 in.	Depth, 10 in.	Depth, 11 in.	Depth, 12 in.
	Breadth, inches.	Breadth, inches.	Breadth, inches.	Breadth, inches.	Breadth, inches.	Breadth, inches.	Breadth, inches.
5	4¾	3	2				
6	6¾	4	3	2			
7		5½	4	2½	2		
8	...	7	5½	3½	2½	2	
10	...		8	5½	4	3	2½
12		8	6	4½	3½
	Depth, 13 in.	Depth, 14 in.	Depth, 15 in.				
	Breadth, inches.	Breadth, inches.	Breadth, inches.				
14		8	5½	4½
16	4½	3½	3½	...	10½	7½	6
18	5½	4½	4	...		10	7½
20	7½	6	4½		9½

TABLE of the SCANTLINGS for GIRDERS of Baltic pine recommended by Tredgold for different bearings from 10 to 36 feet—girders 10 feet apart from middle to middle.

Length of bearing in feet.	Depth, 10 in.	Depth, 11 in.	Depth, 12 in.	Depth, 13 in.	Depth, 14 in.	Depth, 15 in.	Depth, 16 in.	Depth, 17 in.	Depth, 18 in.
	Breadth, inches.	Breadth, inches.	Breadth, inches.	Breadth, inches.	Breadth, inches.	Breadth, inches.	Breadth, inches.	Breadth, inches.	Breadth, inches.
10	7½	5½	4	3½	2¾	2¼	1¾	1½	1½
12	10½	8	5¾	5	3¾	3¼	2¾	2¼	2
14	14¼	10¾	7¾	6¾	5½	4½	3¾	3	2½
16	18¾	14	10½	8¾	7	5¾	4¾	4	3½
18		17¾	13	11	8¾	7¼	6	5	4
20	...		16	13½	10¾	9	7¼	6	5½
22	19½	16½	13	10¾	8¾	7½	6½
24		19½	15½	12¾	10½	8¾	7½
26		18¼	15	12¼	10¼	8¾
28			17¼	14¼	11¾	10
	Depth, 19 in.	Depth, 20 in.	Depth, 21 in.						
	Breadth.	Breadth.	Breadth.						
30	9¾	8½	7½	19¾	16½	13½	11½
32	11	9½	8½		18½	15½	13
34	12½	10¾	9½		17½	14¾
36	14	12	10½	19½	16½

TREDGOLD'S RULES FOR SCANTLING OF FLOOR TIMBERS—

L=Length in feet. B=Breadth in inches. D=Depth in inches.

Bridging or Common Joists (12 inches from centre to centre).—

$$D = \sqrt[3]{\frac{L^2}{B}} \times 2.2 \text{ for fir, or } \times 2.3 \text{ for oak.}$$

Trimmers and Trimming Joists (see p. 91).

Binding Joists (6 feet apart).

$$D = \sqrt[3]{\frac{L^2}{B}} \times 3.42 \text{ for fir, or } \times 3.53 \text{ for oak.}$$

$$B = \frac{L^2}{D^3} \times 4.0 \text{ for fir, or } \times 4.4 \text{ for oak.}$$

Girders.— $D = \sqrt[3]{\frac{L^2}{B}} \times 4.2 \text{ for fir, or } \times 4.34 \text{ for oak.}$

$$B = \frac{L^2}{D^3} \times 7.4 \text{ for fir, or } \times 8.2 \text{ for oak.}$$

Ceiling Joists (12 inches from centre to centre).—

$$D = \frac{L}{\sqrt[3]{B}} \times 0.64 \text{ for fir, or } \times 0.67 \text{ for oak.}$$

When ceiling joists are of the usual thickness of 2 inches, half the length of bearing in feet will give the depth in inches.

CHAPTER VI.

CARPENTRY—(Continued).

PARTITIONS.

PARTITIONS are used to divide rooms from one another, instead of walls, to save space and expense.

Quartered Partitions consist of framings filled in with light scantlings or "*quarterings*," upon the sides of which laths are nailed and plastered.

These may be "framed" or "common."

Bricknogged Partitions have the intervals between the quarterings filled in with brickwork, upon which the plastering is laid.

General Remarks (chiefly from Tredgold's *Carpentry*).—Partitions containing timber should not be used on the floor next to the ground, as the wood is affected by the damp and decays. Stone or brick walls are therefore preferable in such positions.

A quartered partition sometimes rests on the party wall of the ground-floor. This is not a good arrangement, as the partition becomes cracked in consequence of its being unable to settle together with the main walls to which it is fixed.

Nor should the weight of the partition be allowed to rest on the floor below it, as it bears heavily upon the joists, cracks the ceilings below, and also settles and tears away from the ceiling above it.

A better arrangement is to suspend the partition from the floor or roof above; this prevents the cracking of the cornice above the the partition.

Of course, if the weight of the partition be thrown upon either of the floors or the roof, these latter must be strengthened accordingly.

By far the best plan, however, is to make the partition self-supporting, depending only on the main walls carrying its ends, and forming, in fact, a very deep truss.

If the trussed partition be supported by two walls of very unequal height they may settle unequally, and, if so, will cause it to

crack. If the walls are of equal height and well founded they will settle equally, and the partition moving with them will sustain no injury.

The framing of the truss should be so arranged as to throw the weight upon the points of support in the walls at the end of the truss.

Quartered Partitions.—**FRAMED PARTITION WITHOUT DOORWAYS.**—This may be formed like an ordinary king-post truss, filled in as described below.

FRAMED PARTITION WITH ORDINARY DOORWAY IN THE CENTRE.—A truss of queen-post form may be used, as in Fig. 219, which is taken from Tredgold's *Carpentry*.

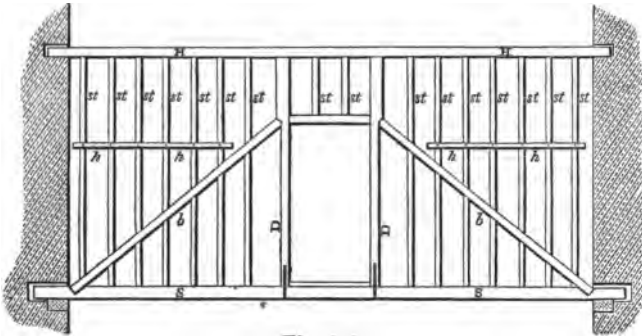

Fig. 219.

The *braces*, *bb*, correspond to the principal rafters, and Tredgold recommends that they should be inclined at an angle of about 40° with the sill *SS*.

The doorhead fulfils the part of the straining beam,¹ while the bottom plate or "*sill*,"² *SS*, corresponds to the tie beam, and may pass between the joists under the floor boards.

The ends of the top plate or "*head*," *H*, of the truss are received by the walls which support the partition, but they should not rest upon the walls unless the studs are secured by straps to the head.

The filling-in pieces, "*studs*," "*quarterings*" or "*quarters*," *st*, should be of light scantling, just so thick—about 2 inches—that the laths can be nailed to them. They are tenoned to the top and bottom plates, butted and nailed on to the braces. They should be stiffened at vertical intervals of 3 or 4 feet by short struts called "*nogging pieces*,"³ or by continuous rails, *hh*, notched on to the uprights and nailed to them.

¹ See Part II.

² Sc. *Sole*, or sometimes *Bottom Runner*.

³ Sc. *Dwangs*.

The studs, D, on each side of the doors are called the *door studs*, "*principal posts*," "*uprights*," or "*double quarterings*." To avoid the waste of material caused by checking these out to form shoulders, as shown in Fig. 219, the heads of the braces may be housed and tenoned into them, as in Figs. 220, 221.

The studs should be placed at such a distance apart as will suit the lengths of the laths. These are usually 3 or 4 feet long, and the studs may be at 12 inches' central intervals, so that the ends of the laths may fall upon every third or fourth stud.

FRAMED PARTITION WITH WIDE DOORWAY IN CENTRE.—Fig. 220 shows a partition with queen-post trusses, and having in the centre a wide door-way to receive folding doors.

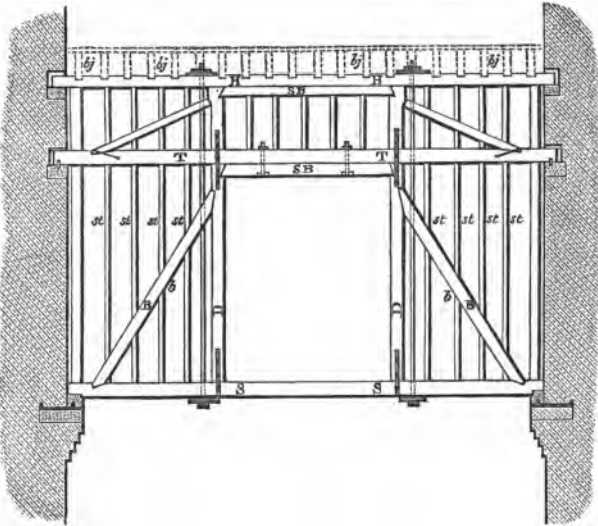

Fig. 220.

It will be seen that the trusses carry the whole weight of the partition, and transmit it to convenient points in the walls, where stone templates are provided to support the ends of the head or top plate H, the *intertie* T, and the sill S.

The framing is further strengthened by the bolts on each side of the door posts.

This is a very strong partition, and adapted for bearing, if necessary, the weight of the floor above it, which latter is shown in dotted lines.

A partition of this form is said to be "one-fourth trussed," sig-

nifying that the upper truss occupies that proportion of the whole depth.

FRAMED PARTITION WITH SIDE DOORS.—The partition in Fig. 221¹ is sustained by the king-post truss over the doorways, from which hangs the lower portion of the framing.

The floor below is dotted in order to show the pieces, *x*, which are framed in between the joists to form a support to the feet of the door posts.

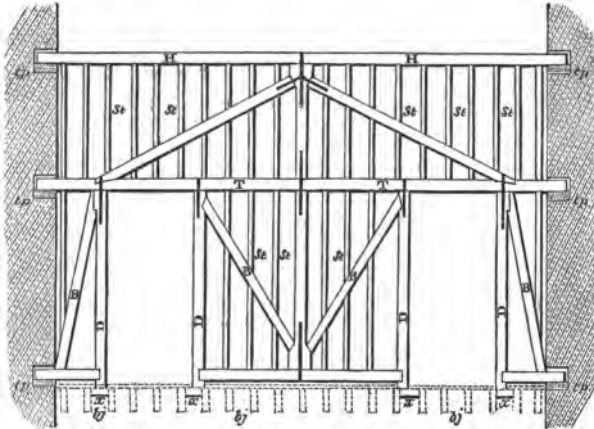

Fig. 221.

The forms of partition devised to suit particular requirements are endless, but the arrangements shown, or modifications of them, will be found to be adapted for most ordinary cases.

COMMON PARTITION.—Tredgold states that when a partition rests on a floor, or is otherwise supported throughout its length, it is better without struts or braces, the quartering being simply steadied by horizontal pieces between them.

He also recommends that when extra strong and sound-proof partitions are required, the studs should not be filled in between the framing but nailed on the outside as battens, and then plastered.

Partitions should be made of very well seasoned timber, and the joints carefully fitted. The whole should be allowed to stand for some time before being lathed, so that the timber may take its bearings and twisted timbers may be put right before plastering.

Wrought-iron tie rods, also cast-iron sockets and shoes, are often

¹ Modified from an example in Newland's *Carpenter's and Joiner's Assistant*.

used (for the same purposes as in roofs) in partitions of large size, or those which have to bear a great weight.

	Pounds per square.
The weight of a square of partitioning may be taken at from	1480 to 2000.
The weight of a square of single-joisted flooring, without counter-flooring	1260 to 2000.
The weight of a square of framed flooring, with counter-flooring	2500 to 4000.
Scantlings for the principal timbers of a partition bearing its own weight <i>only</i> —	
4 inches by 3 inches for bearing not exceeding 26 feet.	
4 " by 3½ " " " 30 "	
6 " by 4 " " " 40 "	

If the partition has to sustain the weight of a floor or roof, the sizes of the timbers must be increased to meet the additional strain that will come upon them.

The filling-in pieces should be just thick enough to nail laths to, about 2 inches (see p. 104).

Any timbers more than 3 inches wide on the face, to which the laths are nailed, should have the corners taken off so as not to interrupt the key for the plaster.—*Tredgold.*

Bricknogged Partitions are screens of timber filled in with brickwork ("*brick nogging*") about 4½ inches thick.

In very common work, or when there is not room for a thicker partition, the brick nogging is of brick on edge, and therefore only 3 inches thick.

In a bricknogged partition the quarterings should be at a distance apart equal to some multiple of 9 inches, so that an exact number of bricks may fit in between them without the expense of cutting.

Horizontal "*nogging pieces*" about ½ inch to ¾ inch thick should be fitted in between them in every third or fourth course of the brickwork. They are frequently placed at much deeper intervals.

CHAPTER VII.

CARPENTRY—(Continued).

TIMBER ROOFS.

THE roof of a building is intended to cover it, and to keep out the weather.

There are many different ways of arranging the timbers of a roof, which vary according to the span, the requirements of the building, the climate, and the nature and weight of the covering to be used.

This course extends only to a consideration of one or two of the most ordinary forms for roofs for small span, and terminates with a description of the "King Post Roof."

It will be well to trace the gradual development of the King Post Roof before describing it in detail.

N.B.—In all the figures illustrating this section, the parts are marked with the distinctive letters mentioned below.

Battens	<i>b</i>	Parapet Wall	PW
Binders	<i>Bi</i>	Pole Plate	<i>pp</i>
Blocking Course	BC	Purlin	P
Boarding	B	Rafters, Principal	PR
Ceiling Joists	<i>cj</i>	,, Common	CR
Cleats	<i>d</i>	Ridge	<i>r</i>
Collar Beam	CT	Slates	<i>s</i>
Cornice	C	Soffit	<i>fs</i>
Corbel	<i>c</i>	Struts	S
Fascia	<i>f</i>	Templates, (wall)	<i>wt</i>
Gutter	<i>g</i>	Tie Beam	T
Gutter-bearer	<i>gb</i>	Tilting Fillet	<i>tf</i>
Gutter-plate	<i>gp</i>	,, Batten	<i>tb</i>
King Bolt	KB	Truss, Principal	TP
,, Post	KP	Wall Plates	<i>wp</i>
,, Tie	KT		

Flat Roof.—The simplest covering for a house would at first seem to be beams laid from wall to wall, forming a flat roof. This

is in use in some countries, but it has many practical disadvantages.

The rain and snow are not thrown off, and will leak through the slightest opening.

In consequence of this, the material to cover a flat roof must be one (such as lead or copper) in which there are no open joints.

Such roofs must be restricted to small spans; if not they will require very heavy timbers, or expensive girders.

Pitch of Roofs.—In order to throw off the rain and snow, it is necessary to tilt up the sides of the roof,¹ giving them a slope as shown in Fig. 222.

The inclination of the sides of a roof to the horizontal plane is called its "*pitch*," and is described either by the number of degrees contained in the angle of inclination to the horizon, or more commonly by the proportion which the height, from the springing line to the apex, bears to the span.

Thus, a roof whose sides slope at $26\frac{1}{2}^{\circ}$ to the horizon, has a centre perpendicular equal to $\frac{1}{4}$ of the span, and is called a roof of $\frac{1}{4}$ or $26\frac{1}{2}^{\circ}$ pitch. The best angle for the slope of the sides of a roof depends upon the material to be used to cover it, the climate, etc. (see "Roof Coverings," Part II.)

This course includes the consideration of slated roofs only, and the pitch found by experience to be the best for slates of different sizes is given at page 142.

A **Couple Roof**² is one formed by the meeting of two beams or rafters, RR, fixed at an inclination. Their feet are nailed and frequently also notched upon a wall plate imbedded on the top of the wall, and their heads meet upon a ridge board *r*, to which they are secured by nails.

In such a roof there is nothing to prevent the rafters from spreading out and thrusting over the walls as shown in dotted lines.

This form of roof may, however, be adopted for spans not exceeding 12 feet.

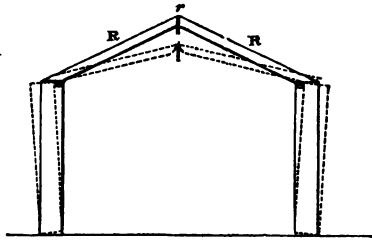

Fig. 222.

¹ When the roof consists of only one slope leaning against a wall, it is called a *Lean-to*—(Sc. *Too-fall*). This, with other forms of roof, will be referred to in Part II.

² Sc. sometimes spelt *Cupple*.

Couple-Close Roof.—To remedy the defect above mentioned, a tie TT is added, which, by holding in the feet of the rafters, prevents them from spreading and thrusting out the walls.

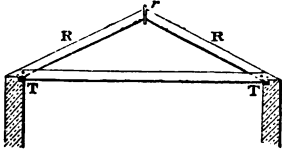

Fig. 223.

The strain on the tie, caused by the tendency of the rafters to settle and spread out can easily be calculated, and it

will be found that a comparatively slight rod of iron will be sufficient to hold the feet of the rafters together.

In timber roofs, however, a wooden beam is generally used for the tie, and it is frequently required to act as a ceiling joist, or to carry ceiling joists, for which an iron rod would not be suitable.

These wooden "tie-beams," especially when loaded, have a tendency to "sag," or droop in the middle, and to draw the walls inwards.

SCANTLINGS FOR COUPLE CLOSE ROOFS¹ of Baltic Fir Timber, with rise $\frac{1}{4}$ span; slated with countess slates on boarding.

Span from centre to centre of Wall Plates.	Rafters, R.	Ridge Board, r.	Ceiling Joists, T.	Remarks.
8 feet.	2 $\frac{3}{4}$ by 2	7 by 1 $\frac{1}{2}$	4 by 2	These spans should have a collar, but in that case the dimensions given at page 111 may be used.
10 "	3 $\frac{1}{4}$ by 2 $\frac{1}{2}$	7 by 1 $\frac{1}{2}$	5 by 2	
12 "	4 by 2 $\frac{1}{2}$	7 by 1 $\frac{1}{2}$	6 by 2	
14 "	4 $\frac{1}{2}$ by 2 $\frac{1}{2}$	8 by 1 $\frac{1}{2}$	7 by 2	
16 "	5 by 2 $\frac{1}{2}$	7 by 1 $\frac{1}{2}$	8 by 2	
18 "	5 $\frac{1}{2}$ by 2 $\frac{1}{2}$	8 by 1 $\frac{1}{2}$	9 by 2	

Collar-Beam Roofs.—In buildings where considerable height is

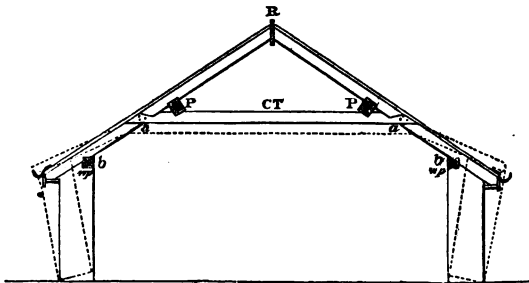

Fig. 224.

required internally, or in those with low walls where the tie-beam would be in the way of the occupants, it is replaced by a "collar-

¹ From Wray's *Application of Theory to the Practice of Construction*.

"beam,"¹ CT, placed higher up, as shown, so as to give the required space below.

This is a bad construction; the lower parts, *ab*, of the rafters, are liable to bend, and as they are not tied in at the feet they thrust on to the walls, tending to force them out, as shown in dotted lines.

This tendency is sometimes aggravated by using the supported rafters as *Principals*,² placing them 8 to 10 feet apart, and adding purlins, *pp*, resting upon the collar as shown; these carry light intermediate rafters, the weight of which, with their load, increases the evils already pointed out.

The collar is generally about half-way up the rafters, and is intended to act as a strut and support them in the middle, but when the walls give way the collar becomes a tie, and tends to assist the bending of the rafters.³

This construction is therefore objectionable, except for small buildings not exceeding 18 feet span, when the distance *ab* is small, the rafters stout enough to prevent bending, and the walls thick in proportion to the span. When a ceiling is applied to a collar-beam roof it follows the line *baab*. The collar-beam is sometimes supported by an iron rod hanging from the ridge R.

There are many forms of roof in which the tie-beam is dispensed with for the sake of appearance, or to gain height. Several of the Gothic roofs are of this class, but the consideration of such is beyond the scope of these notes.

If a tie beam at the level of the springing be added to a collar-beam roof, as shown by the dotted line in Fig. 233, the collar becomes permanently a strut, and a very good roof is formed.

SCANTLINGS for COLLAR-BEAM ROOFS⁴ (without tie beams).

Rise, $\frac{1}{4}$ span; slated with countess slates on boarding.

Span from centre to centre of Wall Plates.	Rafter.	Ridge.	Collar.	Remarks.
8 feet.	3 by 2	7 by 1 $\frac{1}{2}$	2 by 2	In these spans it is not necessary to use the collar except to carry the ceiling.
10 "	3 $\frac{1}{2}$ by 2	7 by 1 $\frac{1}{2}$	2 $\frac{1}{2}$ by 2	
12 "	4 by 2	7 by 1 $\frac{1}{2}$	3 $\frac{1}{2}$ by 2	
14 "	3 by 2 $\frac{1}{2}$	7 by 1 $\frac{1}{2}$	4 $\frac{1}{2}$ by 2	
16 "	3 $\frac{1}{2}$ by 2 $\frac{1}{2}$	7 by 1 $\frac{1}{2}$	5 by 2	
18 "	4 by 2 $\frac{1}{2}$	7 by 1 $\frac{1}{2}$	5 $\frac{1}{2}$ by 2	

¹ Sometimes called *Top-beam*, *Wind-beam*. Sc. *Baulk*.

² See p. 113.

³ The weakness of the lower part of the rafters is sometimes remedied by strapping pieces under them from *a* to *b* (see Fig. 224). These pieces may be continued so as to fill the angle at *a*, and support the collar beam.

⁴ From Wray's *Application of Theory to the Practice of Construction*.

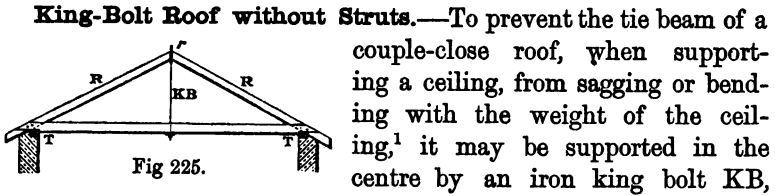

suspended from the ridge *r*.

For spans of from 14 to 18 feet a collar may be introduced half-way up the rafters to stiffen them.

We have now arrived at a form of roof in which the feet of the rafters cannot spread outwards, and whose tie beam is prevented from sagging or drooping in the centre.

King-Post Roof.—When it is attempted, however, to apply the last-mentioned construction to large spans, it is found that the weight of the roof covering, of snow, and the pressure of the wind upon the rafters, are too much for them, and that they have a tendency to bend.

It is necessary, therefore, that they should be supported in the middle, and this is done by means of wooden props called "*braces*" or "*struts*," SS, Fig. 226.

These struts are placed with their upper ends under each rafter, near its centre point,² their lower ends being secured to the vertical tie of the roof.

It is somewhat inconvenient to attach the feet of the struts to an iron rod, and therefore the vertical tie in wooden roofs is generally made of timber and called a "*King Post*" or "*King Piece*," the head and feet of which are conveniently shaped to receive the rafters and struts.

The struts *may*, however, be fixed to the foot of an iron king bolt, as shown in Fig. 188.

The rafters, being now supported in the centre, are reduced to half their former bearing, and are able therefore to bear twice the load that they could before have sustained.

The resulting framework (see Fig. 226), consisting of the rafters PR, king post KP, struts S, and tie beam T, is known as a *King-Post Truss*.

¹ In order to obtain a really stiff ceiling, it is a good plan to introduce heavy tie beams or binders, at intervals of 8 or 10 feet in the length of the roof, supported in the centre by an iron rod, as shown. These beams act as ties, and also carry the ceiling joists, which then run at right angles to them, and are notched to their under side.

² With regard to the exact position of the struts, see page 118.

Such a truss is well adapted for roofs having a span not exceeding 30 feet.

The remaining parts shown in Fig. 226, lettered CR, P, B, G, H, are not portions of the truss itself, but are supported by it.

It would for many reasons be inconvenient to have trusses such as that just described so close together that they would carry the slates or other roof covering without any intermediate bearers.

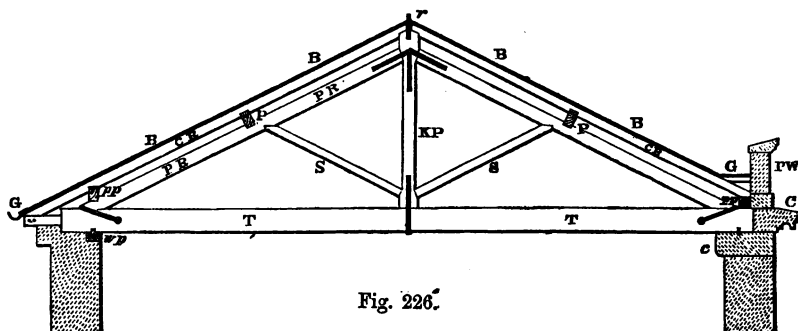

Fig. 226.

Occasionally very light trusses, made simply of boards nailed together in something like the king-post form, are so used, but the general practice is to set up trusses along the building,¹ about 10 feet apart, and each strong enough to bear the weight of the portion of roof (one "bay") that will be carried by it.

Across these trusses or "*Principals*" are laid *purlins* PP, and upon the purlins are fixed smaller or "*common rafters*" CR, which carry the *boarding* B (or *battens* where they are used) for the slates.

Other members are also found necessary, such as *wall plates*, wp, to give the ends of the tie beam a grip upon the walls; a *ridge piece*, r, to unite the tops of the trusses longitudinally and receive the upper ends of the common rafters; and *pole plates*, pp, to receive the feet of the common rafters.

Fig. 227 represents part of a king-post roof, showing two principal trusses with some of the members resting upon them, nearly all the boarding being omitted, and also most of the common rafters between the principals, in order that the trusses and purlins may be seen more distinctly.

The walls supporting the roof are surmounted by parapets; part of one is broken away in order to show the roof timbers and a portion of the woodwork of the gutter formed behind it.

¹ These should be over the piers between the windows, not over the openings.

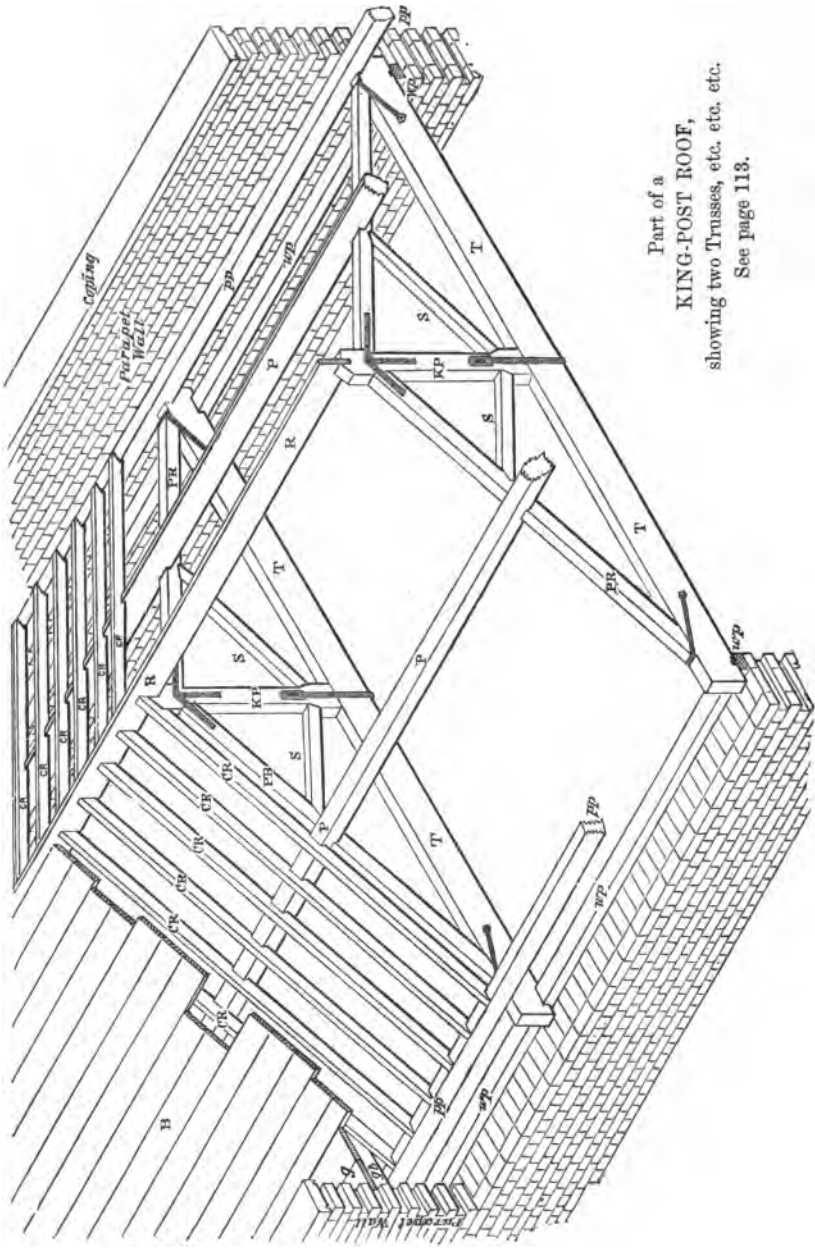

Part of a
KING-POST ROOF,
 showing two Trusses, etc. etc. etc.
 See page 113.

Fig. 227.

PARTS OF A KING-POST ROOF.

We will now proceed to consider the different parts of a king-post roof in detail.

The Wall Plates are pieces of timber imbedded in mortar on the tops of the walls to carry the ends of the tie beam and distribute its weight. They are sometimes bolted down to the wall so as to secure the roof in case of high winds.

The tie beam should be notched or coggled upon them, but is frequently only nailed to them.

It is an advantage to have the wall plate over the centre of the wall, so as to bring the weight fairly upon the masonry, but this increases the bearing of the tie beam and causes expense. Wall plates are therefore generally placed so as to be flush with the inner faces of the walls.

At the angles of buildings the wall plates are halved, dove-tailed, or notched into one another, and well spiked together, and halved or scarfed wherever it is necessary to join them in the direction of their length; they should, however, be in long pieces, so as to avoid this as much as possible.

In roofs of very wide span two wall plates parallel to one another, and a few inches apart, are sometimes placed on each wall, so as to secure the tie beam more firmly.

Templates are long flat stones frequently substituted for wall plates. They have the great advantage of not being subject to decay or destruction by fire.

The tie beams either merely rest upon them or are secured by joggles.

Wall plates which are not continuous, but which are placed under the ends of the trusses in pieces only sufficiently long to distribute the weight, are also sometimes called *templates*.

The Tie Beam.¹—As far as the roof itself is concerned, this member has nothing to do but to hold in the feet of the rafters to prevent them from spreading, and it would thus be subject only to a tensional strain.

In many cases, however, it carries the ceiling joists (see Figs. 228 to 231), and it has then to bear the cross strain caused by the weight of the ceiling.

To prevent it from sagging or drooping in the centre, the tie

¹ Sc. sometimes called *Tie joist*.

beam should be supported at one or more points in its length. As a rule, there should not be more than 12 to 14 feet between the points of support.

In a king-post roof there is generally only one such point of support, and it is in the centre of the tie beam (see p. 124).

The tie beam receives the feet of the rafters in oblique mortises (see page 69), the joints being further secured by straps or bolts.

As a point of construction, it is better that the joint between the foot of the rafter and the tie beam should be over the wall, as shown in Figs. 226, 230, instead of within it, as in Figs. 227, 231. The latter position exposes the tie beam to unnecessary cross strain, but as it allows a wider span between the walls, with the same amount of timber in the roof, it is very frequently adopted.

In such a case, iron, stone, or wood corbels (see Figs. 185, 186, 226) or brackets (Fig. 235) are often provided, so that the bearing of the tie beam is reduced, and support is afforded to it just below the points where the rafters bear upon it.

The ends of the tie beam are notched or coggled, and nailed upon the wall plates, and should be left with a free circulation of air around them. The tie beam is frequently "cambered" in the middle to allow for sagging, so that after it has taken its bearing it may be horizontal. When there are ceiling joists attached to the tie beam, the same object may be effected by keeping them a little higher at the centre (see page 100, Floors), varying the depth of the notches on their upper sides.

The centre of the tie beam is upheld by being strapped (see Fig. 228) to the king post. The shrinking of the timbers will cause the tie beam to separate from the foot of the king post; the strap should therefore be furnished with adjusting wedges (*c c*, Fig. 229), which can be tightened up to counteract this.

A slot or rectangular hole is made in the strap and through the post, to receive these iron wedges, or, as they are technically called, "*cotters*;"¹ they are enabled to slide easily, and prevented from crushing into or indenting the wood by iron shields above and below called "*gibs*" (*g g*, Fig. 229), which are so formed as to clip the sides of the strap and keep them close to the king post; the manifest effect of driving the wedges inwards is to raise the upper gib and strap, and with it the tie beam it supports.

Fig. 229 shows the position of the wedges before tightening up.

The slots should be so arranged that there is before driving

¹ Sometimes called *keys*.

the wedges a space in the king post at *x*, above the upper gib, and one in the strap at *y* below the lower gib, so as to admit of the strap being raised until the tie beam is as close up to the king post as possible.

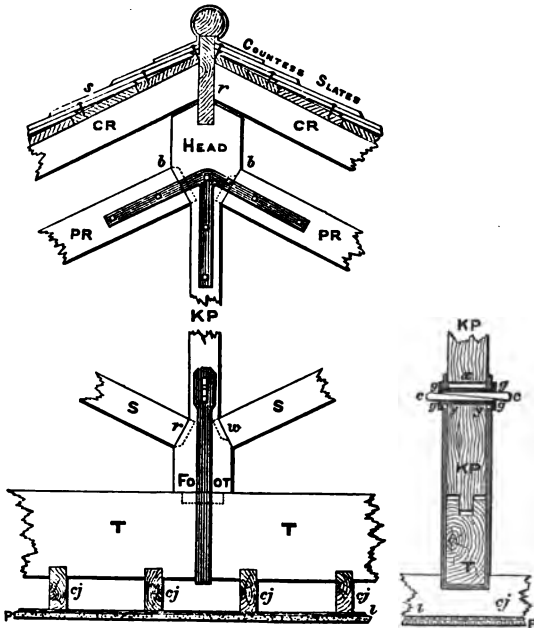

Fig. 228.

Fig. 229.

The King Post, or "*King Piece*," is intended merely as a tie to hold up the centre of the tie beam and prevent it from sagging, for which purpose it is united to it by the strap or stirrup just described.

The head (see Fig. 228) is if possible enlarged, so as to afford a bearing perpendicular to the pressure of the principal rafters (see page 71), and bevelled and mortised to receive their upper ends, which are tenoned into it.

The top of the head may be left square, as in Fig. 167, when there is no common rafter immediately over the Principal, or bevelled off parallel to the backs of the common rafters where they occur (Fig. 227). A groove is cut in it to receive the *ridge, r*.

The foot (Fig. 228) is similarly arranged to receive the feet of the struts.

The lower the block at the foot of the king post the better will the struts be placed for taking the strain upon them.

The head of the king post sometimes becomes so compressed by the rafters that the fibres are crushed, and the post sinks, allowing the tie beam to sag. On this account oak king posts have been used, as they are less compressible, and it is a strong reason in favour of king bolts.

Any shrinkage in the width of the king post will cause the rafters to come nearer together at the head, and the struts to do the same at the foot.

It is therefore necessary that the head of the king post and of the principal rafters should be fastened together with straps as shown. Occasionally provision is made for tightening the joint by means of gibs and cotters similar to those for the foot of the king post described at page 117.

The joints between the ends of the principal rafters and the head of the king post should be left a little open at *bb*, Fig. 228, so as to allow the ends of the rafters to bear inwards when the roof settles, without crushing the angles at *bb*.

The foot of the king post is kept in position by a stub tenon, and secured to the tie beam either by a strap with adjusting wedges, as above described; or by a common stirrup; or by a bolt passing through the tie beam and secured into a nut fixed within the king post; or by a dovetailed tenon penetrating the whole depth of the tie beam, and secured by a wedge as described at p. 68.

When the truss is first put together, the foot of the king post should be kept well clear of the tie beam, so that in case of a general depression of the roof it may not bear upon it. The tie beam is raised by the adjustment of the cotted joint after the roof has taken its bearing.

Suspending Pieces, as described at page 74, may sometimes be used instead of king posts.

The Struts¹ prevent the principal rafters from sagging in the middle. In order to guard against any cross strain whatever coming upon the rafters, the heads of the struts should be almost immediately under the purlins² (see Fig. 230), but this cannot always be arranged without inclining the struts at too flat an angle. The more upright they are, the better they are placed for bearing the strain upon them.

The heads of the struts are tenoned into the principal rafters,

¹ Also called *Braces*.

² The exact position of the head of the strut should be a little lower than the centre of the purlin, so as to meet the resultant of the forces caused by the wind-pressure and the weight of the roof.

as shown in Fig. 230, and their feet into the foot of the king post. The tenons may be formed either as at *v* or as at *w*.

The struts, being under compression,¹ should be made of full length and of very dry stuff, for unless well seasoned they will shrink (even in length) and allow the rafters to bend.

The **Principal Rafters** are tenoned at the upper end into the head of the king post (Fig. 228), and at the lower end into the tie beam, as shown in Fig. 230 and at page 69, the joints being secured by straps or bolts, as described at pages 70 and 78.

The heads are sometimes secured in cast-iron sockets, and the feet in shoes (see pages 80, 81).

The principal rafters carry the purlins, which are notched to fit them, the back of the rafter being coggled to receive the notch.

Each principal rafter is supported near its centre, close below the purlin, by a strut tenoned into it, as shown in Fig. 230.

This halves the bearing, and therefore doubles the strength and stiffness of the rafter.

A shrinkage in the depth of the rafters will cause them to sag, or to separate from the struts. If they shrink in length, the king post will subside between them, and will tend to bear upon the tie beam instead of holding it up.

The **Purlins**² are beams running longitudinally from Principal to Principal as supports for the common rafters.

They are sometimes framed in between the principal rafters, but this weakens the latter and is a bad construction.

The purlins are generally notched where they rest upon the principal rafters, so as to keep the latter rigidly apart; but if a cog is formed upon the back of the rafter it should be very wide, so as to leave the latter as nearly intact as possible.

As an additional precaution, the purlins are supported by blocks of wood (*c*, Fig. 230) called "*cleats*," which may be housed into the backs of the rafters, as shown in Fig. 230, or merely spiked to them, as in Fig. 231.

The best position for purlins is immediately over the head of the strut, as before mentioned (see p. 118 and Fig. 230), in order that they may cause no cross strain on the principal rafters; but they are generally placed (see Fig. 226) so as to support the common rafter at equal intervals, without reference to their exact position as regards the struts, the heads of which are placed as nearly under them as possible.

¹ See Part III. ² In some parts of England called *side timbers* or *side wavers*.

Two purlins are frequently used on each slope of the common king-post roof (see Fig. 231), and are necessary when the common rafters are so long as to require support at more than one intermediate point.

Purlins should be used in as great lengths as possible,¹ but when the roof is a long one they necessarily require to be "scarfed" or "fished." It is better to connect the lengths of the purlin by butt joints fished on each side than by scarfing them. The latter, however, is the most usual practice. Each purlin should, however, in any case extend over at least two "bays,"² and the scarf should in every case be immediately over a principal truss or partition wall.

In some cases the Principals are placed at considerable distances apart, and the purlins trussed to span the intervals.

When several purlins are fixed on each side of the roof at intervals of a few inches, so as themselves directly to receive the boarding or roof covering, they become in effect horizontal rafters.

The Ridge Piece is a board from 1 to 2½ inches thick (R, Fig. 228) let into the head of the king post and running throughout the length of the roof; against it the common rafters abut.

If the ridge is to be covered with lead, it is surmounted by a long cylindrical piece of wood called the *Ridge roll*³ (see Figs. 228, 273); but with slate or earthenware ridging the roll is not necessary, and the ridge piece is simply blocked off to fit the covering intended (see Fig. 259).

The Common Rafters⁴ are bevelled at the upper end to abut against the ridge piece, and are nailed to it. They may be notched out to fit the head of the king post, as in Fig. 227, or they may pass above it, as in Figs. 228, 231. In the centre they are notched to fit the purlin, and at the lower end nailed and generally notched upon the pole plate.

They should, of course, always be in one piece, and are generally made about 2 inches broad, and placed about 12 inches apart.

In roofs with projecting eaves⁵ the lower ends of the common rafters are carried beyond the pole plate, and the eaves gutter is fixed to them (see Fig. 230).

When the common rafters are broken through by a chimney or other obstacle upon which they cannot rest, they should be

¹ The reasons for this will be explained in Part III.

² A "bay" is the interval between two principals.

³ Sc. sometimes called *Ridge pole*.

⁴ Sc. *Spars*.

⁵ The eaves of a roof are the lower edges of the side slopes.

trimmed round it in the same way as floor-joists are trimmed round a fireplace (see p. 91) or other opening. The section, Fig. 265, shows an example of this.

The trimmers (*tt*, Fig. 265) are sometimes placed vertically, but the best and strongest method is to fix them at right angles to the rafters as shown.

The rafters are generally notched on to the trimmers instead of being tenoned into them, and the trimmer is often supported by a corbel protruding from the chimney.

The common rafters are sometimes placed horizontally, parallel to the ridge, in which case heavy timbers are avoided, and the Principals are more rigidly connected.

The Roof Boarding¹ is nailed upon the common rafters to receive the slates or other covering.

It is generally placed horizontally, running parallel to the ridge; but, in some cases, is made to lie diagonally across the rafters.

When the rafters are placed horizontally, the boarding, of course, runs down the slope of the roof, thus its ends instead of its sides are presented to the descending wet, and it is more likely to be preserved from decay.

The boarding is often covered with felt, which is a non-conductor of heat and cold, and, moreover, keeps the roof dry in case of any failure in the slating.

BATTENS are frequently used in common roofs to carry the slates or tiles. If so, they are nailed at right angles to the common rafters, parallel to one another, and at the "gauge" or distance apart required for the covering to be used (see p. 143, and Fig. 258).

The Pole Plates² generally rest on the ends of the tie beams, being as a rule notched and spiked to them, and run parallel to the length of the roof. They receive the ends of the common rafters, which are generally birdsmouthed, to fit upon the plate.

The pole plate is usually placed immediately over the wall plate, so that the weight upon it is transmitted directly through the latter to the wall (see Figs. 227, 258), but in some cases the position has to be altered. For instance, in Fig. 230, where the joint between the rafter and tie beam rests upon the wall, the pole plate, in order to be immediately over the wall plate, would necessarily be placed so as to cut into and weaken the principal rafter as shown in dotted lines.

This position for the pole plate, though objectionable for the

¹ Sc. *Sarking*.

² Sc. *Poll plate*.

reason stated, is sometimes advisable. For example, in the case where room is required to form a gutter between it and the blocking course (see Fig. 270), or in the valley between two roofs where a wide gutter is required (Fig. 269).

Generally speaking, the position and size of the pole plates depend upon the form of the roof, method of fixing the gutters, etc. and are very varied.

Ceiling Joists.—When a ceiling is required, the joists to support it are generally notched and nailed to the under side of the tie beam, as shown in Figs. 228 to 231.

Ceiling joists attached to roofs are similar to those fixed below floors, as described at p. 99.

The Eaves are the lower edges of the slopes of a roof. They

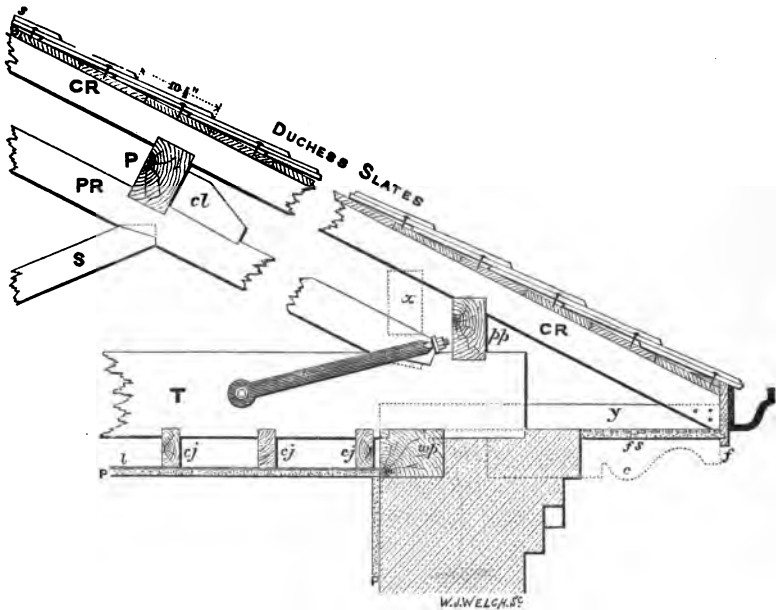

Fig. 230.

may project over the walls, as in Figs. 224, 230; or they may finish upon an iron gutter on the top of the wall, as in Fig. 256; or upon a lead gutter formed behind a blocking course, or a parapet wall, as in Figs. 265, 270.

When the eaves project considerably, as in Fig. 230, small joists, *y*, may be fixed to support the *Soffit* or *Planceer*, which is formed either by boarding the under sides of the joists, or by lathing and plastering them as shown.

In some cases the soffit is supported by *Eaves corbels*, *Cantilevers*, or *Consoles* (as dotted at *c*), built into the wall.

A *Fascia Board*, *f*, is fixed to the ends of the rafters, and to it the gutter is attached. When the eaves project only a few inches, the small joists, *y*, become unnecessary, and the roof is finished as in Fig. 224.

Gutters.—It is necessary to provide for carrying off the rain-water and snow from the roofs, to prevent them from running over the face of the building, and in many cases to collect them for storage and use.

This is effected by gutters of different forms leading to vertical "down pipes," which latter conduct the water to drains provided for it. Some of the principal forms of iron and lead gutters are described in Chap. X. under the head of Plumbers' Work.

Wooden gutters are sometimes used in the country, or for very temporary buildings. They consist merely of V-shaped or rectangular channels made of boards nailed together, and require no further description.

Sizes of Roof Timbers.—TABLES OF SCANTLING.—The following table, from Tredgold's *Carpentry*, gives the *scantlings* (or sizes) of timbers for King-Post roofs with ceilings. The trusses are supposed to be not more than 10 feet apart, the pitch of the roof about $\frac{1}{4}$ or 27°, the covering slates, and the timber Baltic fir.

KING POST ROOFS.—TABLE of SCANTLINGS of TIMBER, recommended by Tredgold, for different spans, from 20 to 30 feet.

Span.	Tie beam, T.	King Post, K.P.	Principal Rafters, P.R.†	Braces or Struts, S.	Purlins, P.	Common Rafters, C.R.
20 feet.	9½ by 4	4 by 3	4 by 4	3½ by 2	8 by 4½	3½ by 2
22 "	9½ by 5	5 by 3	5 by 3	3½ by 2½	8½ by 5	3½ by 2
24 "	10½ by 5	5 by 3½	5 by 3½	4 by 2½	8½ by 5	4 by 2
26 "	11½ by 5	5 by 4	5 by 4½	4½ by 2½	8½ by 5	4½ by 2
28 "	11½ by 6	6 by 4	6 by 3½	4½ by 2½	8½ by 5½	4½ by 2
30 "	12½ by 6	6 by 4½	6 by 4	4½ by 3	9 by 5½	4½ by 2

With regard to this table it should be mentioned that the dimensions given are a safe guide, erring, if at all, on the side of excess of strength. The scantlings for the tie beams may be considerably reduced when there are no ceiling joists attached to them. In practice the width of the King-Post, Principal Rafters, and Struts, is generally made the same as that of the tie beam.

Several points connected with roofs, such as the formation of

Hips and Valleys, the trimming of rafters round chimneys, etc., must be reserved for Part II., as they do not fall within the limits of this course.

ROOFS OF WOOD AND IRON COMBINED.

As the tensional strength of iron is much greater than that of timber, it is generally preferable to use the former for any member exposed to longitudinal strains only.

Iron king bolts would, as before mentioned, probably have come into general use, but that it is difficult to make a simple and good joint where the feet of the struts rest against them.

Iron tie rods would also be preferred to timber tie beams, if it were not that these often have to carry ceiling joists, which could not conveniently be fixed to iron rods.

In some roofs, however, the first difficulty above mentioned has been overcome; when no ceiling is required the second does not exist, and a judicious combination of iron and wood has been effected.

King-Bolt Roof (Wooden Tie).—In the roof, Fig. 231, a wooden tie beam is retained to carry a ceiling, but a king bolt is used, and the difficulty in forming a joint for the struts at its feet is avoided by the use of a straining piece, SP.

In roofs of a greater span than 24 feet,¹ the tie beam may be

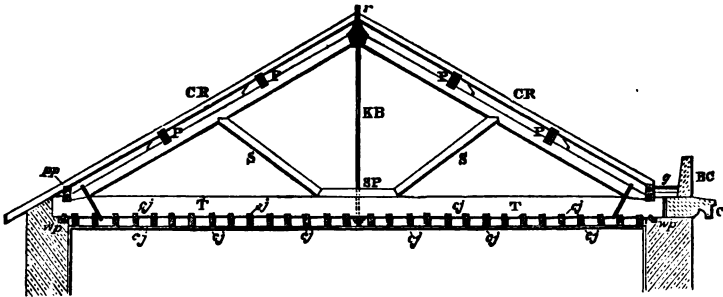

Fig. 231.

supported at intermediate points by similar bolts hanging from the points where the struts meet the rafters.

A further use of iron is here exemplified in the shape of a cast-iron socket to receive the upper ends of the rafters and the king bolt, and to carry the ridge board.

It will be noticed that the principal rafter carries two purlins,

¹ See page 116.

which support the common rafters at intervals equal to a third of their length. The tie beam carries ceiling joists to support a lathed and plastered ceiling.

King-Bolt Roof (Iron Tie).—Fig. 232 shows a roof of which both the king bolt and tie rod are iron. The struts abut against

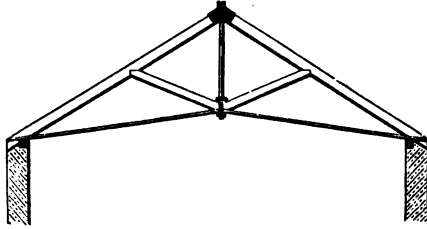

Fig. 232.

one another, and rest upon a nut at the lower end of the king bolt, which can be screwed up so as to tighten the roof if necessary.

Collar-Beam Roof.—In the roof shown in Fig. 233 an attempt is made to remedy the great defect of the ordinary collar-beam construction by providing tension rods to hold in the feet of the rafters. The more nearly horizontal these tension rods are made, the better is their object fulfilled.

When the feet of the rafters are firmly held in by a tie rod in a horizontal position, as dotted, the collar beam becomes permanently a strut, and the construction is a good one.

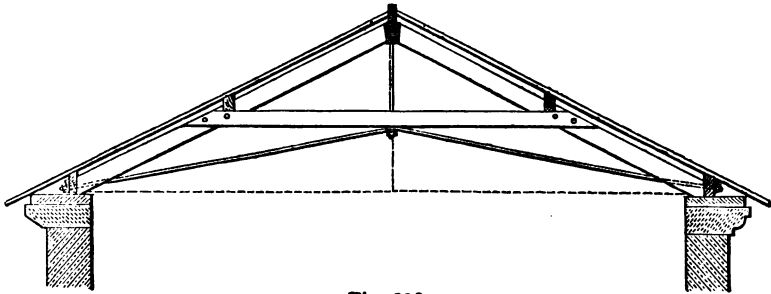

Fig. 233.

The ends of the tension rods and of the king bolt are furnished with screws and nuts, by which they can be tightened up when required.

Those of the tension rods pass through the lower extremities of the rafters, and through plates which abut against the feet of the rafters and extend the whole length of the wall. The upper end of the king bolt is received by a cast-iron socket.

Trussed Rafter Roof.—In the roof shown in Fig. 234 each rafter is trussed by means of a short cast-iron strut, supported by tension rods. The two trussed rafters are prevented from spreading by a tie rod furnished with a union joint (shown in section at *u*), so that it may be shortened if necessary.

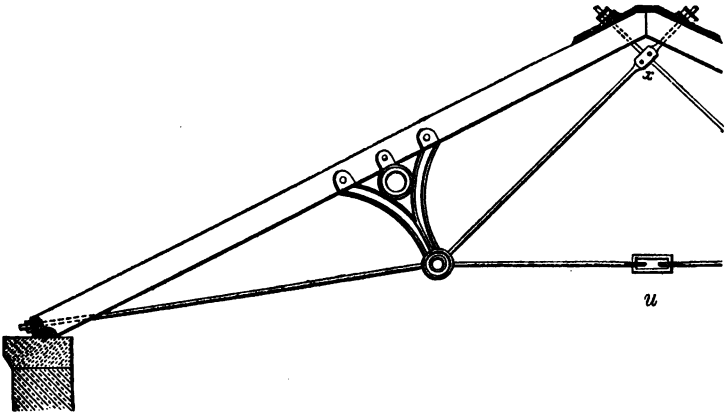

Fig. 234.

The inner ends of the tension rods are received and secured in a hollow circular iron box, which forms the head of the strut (see Fig. 253); the other ends pass through the extremities of the rafters, as shown, screws and nuts being provided in order to tighten the rods, and iron shoes to provide proper bearings at right angles to the strain, and to prevent the nuts from indenting the timber.

One of the tension rods is provided with a slot at *x*, through which the other passes.

Timber rafters, in roofs of which the other members are of iron, are objectionable, for the reasons stated at page 134.

Queen-Bolt Roof.—Fig. 235 gives the section of the roof of a

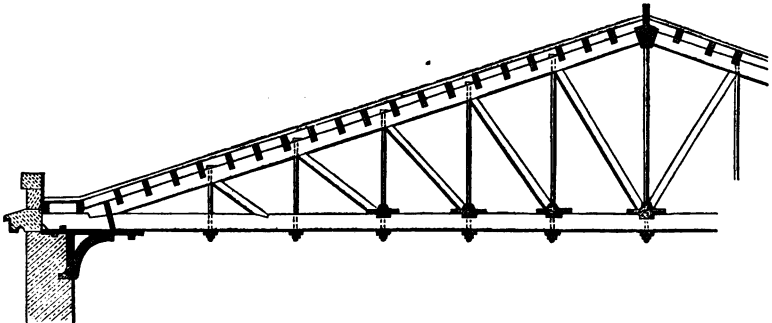

Fig. 235.

shed at London Bridge Station, which is very commonly referred to as a good combination of wood and iron. The feet of the suspending bolts and of the struts are here received by cast-iron shoes. A cast-iron socket carries the head of the king bolt, and a bracket of the same material supports the end of the tie beam.

It will be observed that the boarding of this roof is carried upon a number of horizontal common rafters or purlins.

The tie beam is supported at a great number of points, which renders it peculiarly adapted for carrying a ceiling.

This roof is shown for the sake of illustrating some of the parts, but such a truss would in these days, as a rule, be formed entirely of iron.

CHAPTER VIII.

IRON ROOFS.

AS the machinery for preparing iron bars has improved, and the facilities for obtaining these of any required form have become greater, so iron has gradually, to a great extent, taken the place of wood for roofs, especially those of large span.

When iron was first employed in the construction of roofs, it was used only for those members of the ordinary timber trusses for which it was evidently better adapted than wood.

Some examples of these roofs in the transition state, composed of wood and iron combined, are given in pages 124 to 127.

In process of time iron was substituted, first for one member of the roof, then for another, until the whole truss was composed of iron in different forms.

The result of this gradual change was that the early iron roofs were nearly of the same form of construction as the ordinary timber trusses.

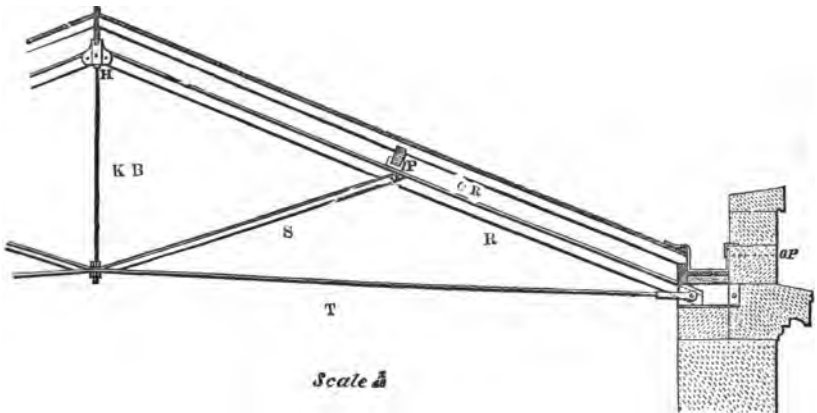

Fig. 236.

Figs. 236, 238 give examples of iron principals resembling those of a king and queen post roof¹ respectively.

¹ The timber queen-post roof does not come within the range of this course, but is described in Part II.

In the king-post roof, shown in Fig. 236, the principal rafters are of T iron, the struts of angle iron, the common rafters and purlins of wood, the latter being supported on the principals by cast-iron shoes. The king bolt is of circular rod iron, fixed at the top into a cast-iron head, its lower end being furnished with a screw, which, passing through holes in the feet of the struts and in the centre of the tie rod, is secured by a nut.

The upper end of each principal rafter enters the cast-iron head, and is secured to it, while the lower end is fastened by a bolt (which passes also through the end of the tie rod) to an iron chair which is secured to the wall.

It will be seen that by screwing up the nut at the foot of the king bolt, the tie rod is raised and the roof tightened up.

Fig. 237 is a common modification of the king-post roof constructed in iron. The dotted lines show additional suspending rods, which may be added in roofs of larger span, *i.e.* above 30 feet.

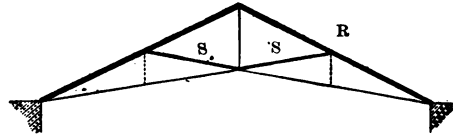

Fig. 237.

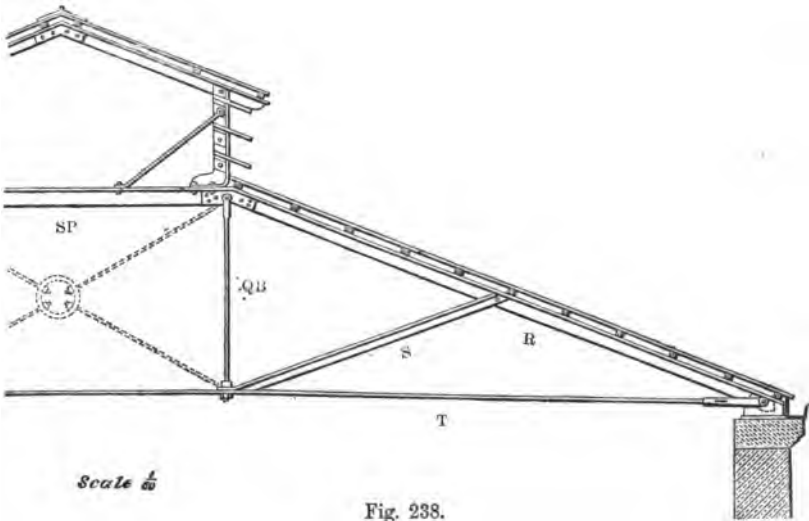

Fig. 238.

Fig. 238 shows an iron roof arranged in the form of the ordinary wooden queen-post¹ roof. The principal rafters and strain-

¹ In iron roofs the term "Queen Rod" roof is generally applied to those having several suspending rods analogous to the Princesses in wooden roofs.

ing piece are of T iron, the struts also of T iron, the queen bolts and tie rod of circular rod iron.

The head of the rafters is secured to the straining piece by plates of iron covering the joint and rivetted to both. The roof boarding is carried by horizontal common rafters, or, as they are usually called, "purlins," of angle iron filled in with wood. On the boarding may be laid slates, corrugated iron, sheet-iron, or zinc.

The end of the tie rod is fastened to the rafter by a bolt, which, passing through both, secures them to a cast-iron shoe fixed upon the wall.

The tie rod may be slightly altered in length by the action of a cottered joint, which is described at p. 137.

The dotted lines show cross braces, which are often added in roofs of more than 30 feet span. In some cases the straining piece is supported in the centre by a curved T iron springing from the feet of the vertical bolts.

This roof is surmounted by a skylight, the construction of which is obvious from the figure.

It will be seen that the parts of the roofs just described are arranged in the same way as those of wood, the only alteration being in their section and in the form of joints by which they are connected.

It was soon noticed, however, that the material could be better applied, and different forms were adopted for iron roofs, some of which will now be described.

Classification of Iron Roofs.—The various forms of iron roofs have been classed as follows:—¹

1. Roofs with straight rafters.
2. Roofs with arched rafters.
3. Mixed roofs, which form a transition between the other two.

Of these, the second and third classes are used chiefly for very large spans, far exceeding those of 40 feet (to which this course is limited). It will, therefore, be unnecessary further to notice them, except in the case of a very simple example of an arched roof, which may here be described before the whole of Class 2 and 3 are dismissed as not coming within the scope of these notes.

Corrugated Iron Arched Roof.—This simple form of arched roof consists merely of sheets of corrugated iron rivetted together into the form of an arch. The edges of the resulting large arched

¹ Unwin's *Wrought-Iron Bridges and Roofs*.

sheet are secured at the springing to wall plates, angle irons, or to the inner sides of iron gutters. The thrust upon the walls is prevented by a horizontal tie rod forming the chord of the arch.

Such an arrangement may well be adopted for spans up to 20 feet, and has been used even for roofs of from 40 to 50 feet in width.

ROOFS WITH STRAIGHT RAFTERS.

The simplest form of iron roof with straight rafters is shown in Fig. 239.

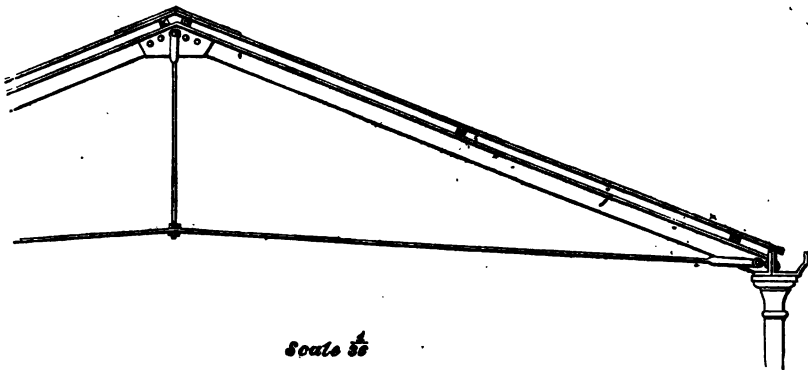

Fig. 239.

The rafters are of T iron, united at the apex by an overlapping plate rivetted to both, and from which is suspended the king bolt, the head of which is furnished with jaws similar to those forming the head of the bolt in Fig. 251, so as to pass on each side of and embrace the plate.

The tie rod is bolted to the lower end of the rafter, and is supported in the centre by a double nut at the foot of the king bolt. The lower end of the rafter is itself secured to the head of the column supporting the roof.

As the rafter is entirely without support, except at the ends, this form of roof is not adapted for spans greater than from 15 to 20 feet.

The roof, when fixed, may be tightened up by screwing the nut at the foot of the king bolt, so as to shorten the latter and raise the tie rod.

Common Trussed Rafter Roof. — TRUSS WITH ONE STRUT. — Fig. 240 is an example of one of the earliest, and still one of the best and simplest forms of iron roof for small spans. In it each

rafter is trussed by means of a strut supporting it in the centre, the strain on the strut being taken up by tension rods which connect the head of the strut with the extremities of the rafter. The thrust upon the walls is counteracted by a horizontal tie rod joining the heads of the two struts, ~~and~~ which holds the trussed rafters together.

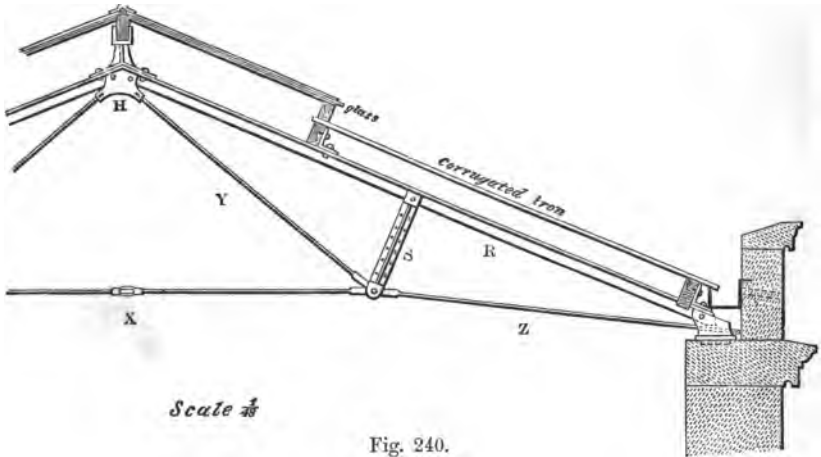

Fig. 240.

In this example the rafters are of T iron, the struts each of two T irons rivetted together (see Fig. 252), with heads formed to receive the ends of the tension rods, as shown, and also those of the tie rod, which unites the two sides of the roof. The higher end of the upper tension rod, Y, is secured to the cast-iron head H, and the foot of the lower tension rod, Z, passes through an iron shoe secured to the wall. Both tension rods can be slightly altered in length by means of cottered joints, and the tie rod by means of the union joint, X, so that they may be brought into a proper state of tension when the roof is fixed.

“The merit of this truss is that the bracing is nearly all in tension.

“Mr. Bow has shown that, if the members are proportioned to the stress, it is more economical of material than any other form.”¹

In the example given the upper purlin is arranged so as to support the lower side of the skylight, otherwise it would be better placed immediately over the head of the strut, so as to cause no

¹ Unwin's *Wrought-Iron Bridges and Roofs*.

cross strain upon the rafter. Some authorities recommend that with trusses of this form the weight of the covering should be distributed by means of angle-iron purlins at short intervals, as in Fig. 242.

In some varieties of this roof the intermediate tie is kept too high, which leaves a strain on the rafter similar to that experienced in a collar-beam roof (see page 110).

This form of truss is adapted for spans of from 20 to 30 feet; it is, however, frequently used for much larger spans. Professor Unwin gives an instance in which it has been adopted for a span of 87 feet, but recommends at the same time that it should be restricted to spans of 60 feet.

As the span of the roof increases, the length of the rafters becomes such that they require support at more points than one.

TRUSSED RAFTERS WITH TWO STRUTS.—Fig. 241 gives an example adapted for spans of from 30 to 40 feet, in which the

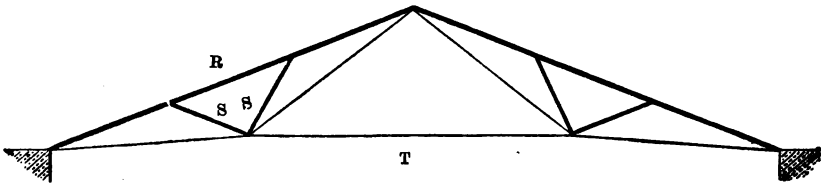

Fig. 241.

rafter is supported at two intermediate points. Such a construction is, however, better adapted for roofs of larger span, and will be further considered in Part II.

Queen-Rod Roofs.—These are modifications and extensions of the old timber roofs with Kings, Queens, and Princesses. (See Part II.)

The example shown in Fig. 242 has rafters and struts of T iron, the tension and tie rods being all of round iron. The main tie rod is secured at the ends to fixed iron chairs by means of joints with jibs and cotters. (See page 135.)

The roof covering of slates is carried by angle-iron purlins rivetted to the back of the principal rafters.

The feet of the struts are secured to the tie rod by bolts with double nuts, figured and described at page 138.

This roof is surmounted by a skylight, consisting of cast-iron louvered standards supporting T iron rafters, which carry angle-iron purlins similar to those of the main part of the roof.

The skylight is strengthened by a tension rod passing across it, and secured to the sides and centre standard by cottered joints.

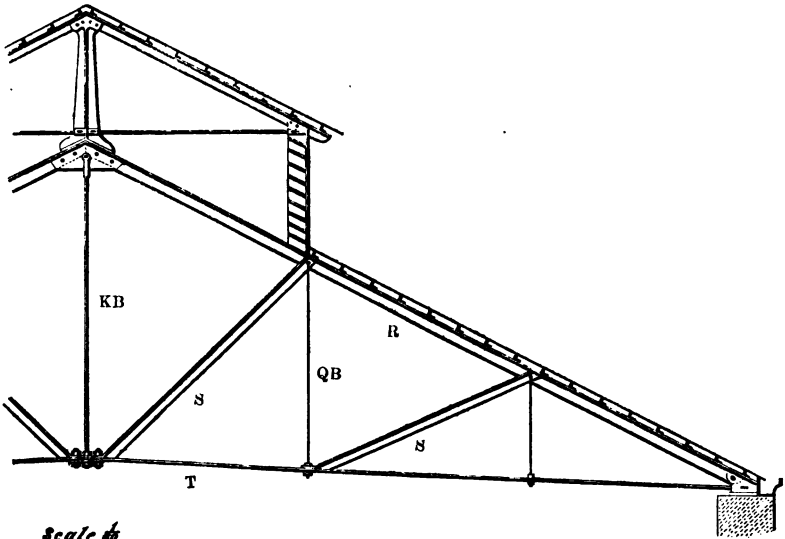

Fig. 242.

A truss of this form is well adapted for carrying a roof-covering resting on purlins placed just above the heads of the struts, so that they cause no cross strain on the rafter.

PARTS OF IRON TRUSSES.

Principal Rafters.—As these are in compression they were originally formed of cast-iron, with the usual double flanged section, frequently tapering in form, the lower flange being made wider in the centre of the length of the rafter than at the ends.

This material being, however, very heavy, and liable to snap suddenly, was soon generally abandoned.

Timber rafters are objectionable in iron roofs, in consequence of the wood and iron not contracting and expanding equally under changes of temperature. Thus, when the tension rod is lengthened by heat, the feet of the rafters are free to spread and thrust out the walls, and, on the other hand, under the influence of cold, the tie rod is so contracted in length as to be subjected to undue and excessive strains, which may break it or bend the rafter.

Wrought-iron rafters for small roofs are most usually made of a T section, with the table¹ uppermost, so as to form a base on which to fix the purlins.

For verandahs and roofs of small span covered with glass, T iron rafters may be used with the table downwards, thus forming sash bars, the glass being fitted into the angles and resting upon the flanges.

Rafters of I section, double-bar rafters, also rafters of double angle-iron, or of channel or bulb iron, are more adapted for roofs of larger span than 40 feet, and will be described in Part II.

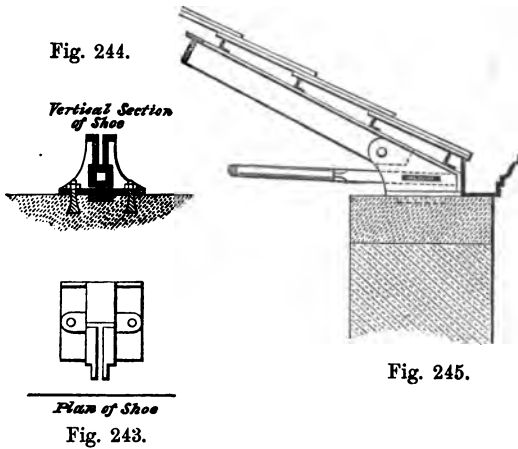

Fig. 244.

Fig. 245.

Fig. 243.

The foot of the principal rafter is generally secured in a cast-iron chair, in between the sides of which the vertical web of the rafter passes, and is fastened by a bolt passing through it and the sides of the chair. In some cases the same bolt secures the tension rod, the end of which is then formed with jaws to pass on each side of the web of the rafter.

Two or three examples of the commonest and simplest forms of these chairs are given in the Figures 236 to 242, and on a larger scale in Figs. 243, 244, 245, 247, 248. Other forms will be given in Part II.

In large roofs, arrangements have to be made to allow free expansion and contraction of the iron, under changes of temperature, but these need not here be described; they will be referred to in Part II.

Tie Rods are generally of rod iron, circular in section. For

¹ In iron of T section the horizontal part of the T is called the *table*, and the vertical part the *web*.

very large spans they may be flat bars, on edge, which have an advantage, inasmuch as they are less liable to sag than a circular tie rod of the same strength. A flat bar, however, exposes a larger surface, and causes a heavy appearance in small roofs.

When flat bars are used, additional strength may easily be obtained by placing two or three bars side by side.

Where bolts pass through a tie rod, the latter is widened out, so as to leave sufficient substance round the hole, in order that its tensional strength may not be reduced.

In small roofs the tie rod may be simply bolted or rivetted to the rafter (see Fig. 239), or to a chair of some description (Fig. 236).

In larger roofs a common arrangement is to form a jib and cotter joint, such as that in Figs. 245, 247, 248.

The centre of the tie rod is upheld by the king bolt, which passes through it, and is secured by a nut on each side of it.¹

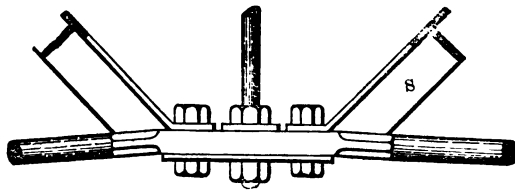

Fig. 246.

The feet of the struts are attached to the tie rod in a similar way, as shown in Figs. 246, 249.

Cottered Joints.—These are used in connection with any member of a roof which it may be advisable to have the power of adjusting, so as to tighten up the truss after it has been put together and into position.

The construction of these joints is similar to that of the joint used by carpenters for connecting a king post with a tie beam, as explained at page 117.

Figs. 247, 248 show a simple example of a cottered joint applied to a tie rod. The end of the tie rod, being flattened out, passes between two plates which are bolted to the chair, and lie on each side of the web of the rafter.

¹ In larger roofs the tie rod is generally severed in the centre, and the ends thus formed are shaped into eyes, through which pass the bolts securing the feet of the struts. An illustration of this is given in Part II.

A rectangular slot is made through the plates, and the end of the tie rod. In this slot are placed two iron wedges or "cot-
ters," *cc*, and the sides of the hole are protected and rendered smooth by means of wrought iron *gibs*, *jj*, so that the wedges may slide easily when driven. As the wedges are driven inwards, they force the slot in the tie rod towards the chair, so that it tends to coincide with the slot in the plates—thus the tie rod is shortened, and the roof tightened up.

One wedge is frequently used instead of a pair, and has the same effect, for, as it is driven in, and the wider part enters the slot, it draws the two members in connection toward each other. Fig. 245 is an example of a cotted joint, the slot for which is formed

in the shoe itself. Fig. 254 gives an elevation of a similar joint (with one wedge only) formed in the head of a king-bolt roof; and at H, Fig. 240, is an iron head adapted for receiving two tension rods of a trussed rafter roof, which are attached to it by cotted joints.

Suspending Rods.—These include *King bolts*, which hang from the apex of the roof, and all rods parallel to them which suspend the tie rod from the rafters.

In iron roofs all suspending rods except the *King bolt* are called *Queen bolts*.

These rods are generally formed with jaws at the upper end, so as to embrace the web of the principal rafter, to which they are secured by a bolt, as shown in Fig. 251.

The lower ends of the rods pass through a hole in the tie-rod, and terminate in a screw carrying a nut, by screwing up which the tie rod may be raised and the truss set up.

Struts should, unless they are very short, be of wrought-iron in preference to cast-iron, as the latter are clumsy, apt to get broken in transit, and to snap suddenly in the work.

For small roofs the struts are generally made of angle or T

Fig. 248.

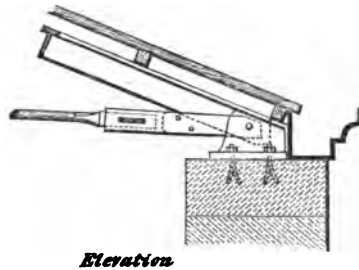

Elevation

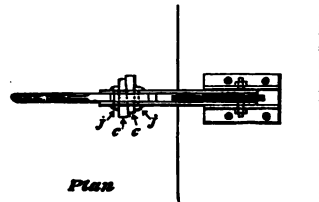

Plan

Fig. 247.

iron, or sometimes of two T irons rivetted together so as to

Fig. 249.

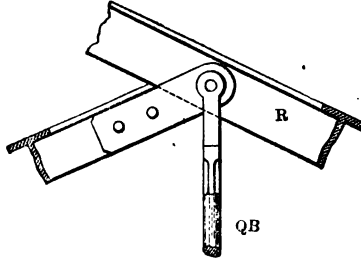

Fig. 251.



*Plan of the rod*

Fig. 250.

form a cross thus—  or of two channel irons similarly united.

Very graceful and efficient struts are formed by flat or angle irons kept apart by distance pieces, varying in length so as to form a tapering beam; these are, however, adapted to larger roofs, and will be described in Part II.

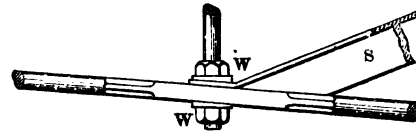
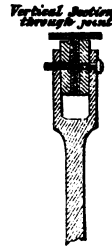
The head of each strut is usually secured to the rafter by flat strips of iron placed on each side of the web of the strut, and rivetted through that of the rafter (see Fig. 249). The end of the web of the strut may be cut off obliquely to fit the under side of the rafter.

The foot of the strut is secured to the tie rod by a bolt passing through the end of the table, which is turned up, and then secured with a double nut, as in Fig. 249. Washers, W W, of a bevelled section, are required in order that the nut may communicate an even pressure to the flange of the strut.

Short struts, such as that for the roof in Fig. 234, are frequently made of cast iron in as light and open a form as possible.

The head of this strut is a hollow circular box, with (see

Fig. 253) openings in the side through which the ends of the tie and tension rods pass, being secured in the inside by knobs, which prevent them from being drawn out. The cover of the head is put on after the rods are inserted.

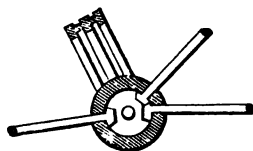

Fig. 253.

Cast-iron struts of a cross-shaped section are frequently used, their upper ends being formed with jaws to seize the web of the principal rafter.

Purlins, properly so called, for carrying common rafters, are seldom used in small iron roofs, but in those of large size they tend to economy, as the principals can be placed farther apart.

Small purlins, or horizontal rafters, which themselves directly support the boarding or roof covering, are however in common use.

These small purlins are generally of an L section—commonly called *angle-laths*—and are frequently filled in with wood, as shown in Fig. 254, for convenience in attaching the roof boarding or other covering.

Iron purlins of T or U section (the latter filled in with wood) are also sometimes used.

Large purlins carrying secondary rafters are best supported by trusses like that in Fig. 242, when they can be placed immediately over the heads of the struts supporting the rafters.

Wooden purlins may be used to avoid the difficulties caused by the expansion and contraction of long iron purlins.

They may be notched on to the principal rafters, and secured to them either by an angle-iron rivetted to both, as in Fig. 240, or by being supported in a cast-iron shoe, as at P, Fig. 236.

The distance apart and arrangement of the purlins depends entirely upon the roof covering to be used, and will be considered under that head in Part II.

Heads.—The simplest way of securing the upper ends of the rafters is by rivetting a flat plate on each side of them, as shown in Figs. 239, 242. This plate also serves to carry the upper end of the king bolt.

Cast-iron heads are often used to receive the rafters—of these there is a great variety.

A very simple form of cast-iron head is shown in Fig. 254; the ends of the rafters pass into slots in the side of the head, and

are there secured by bolts; the upper part of the head is formed to receive the ridge board, and the body receives the king rod,

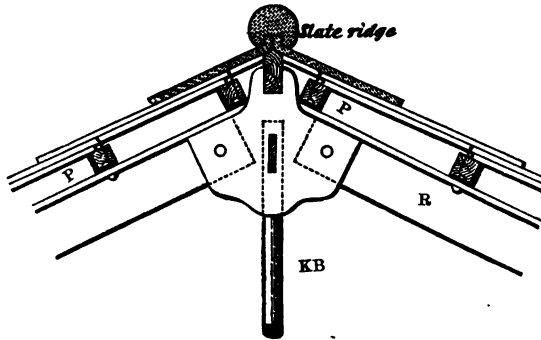

Fig. 254.

which is secured by a cottered joint arranged so that the rod may be slightly shortened in order to raise the tie rod and set up the truss when necessary.

The head shown in Fig. 240 is a little more complicated; in addition to the rafters, it has to receive two tension rods, which are united to it by cottered joints.

Coverings for Iron Roofs.—Several kinds of covering are used for iron roofs—such as slates, corrugated iron, sheet iron, cast-iron plates, tiles (occasionally), zinc, and glass.

The peculiarities of these different materials will be discussed in Part II. The only roof covering which comes within the scope of the Elementary Course is slating (see page 142).

Pitch of Iron Roofs.—The inclination of the slopes of iron roofs should, as in wooden roofs, depend upon the nature of the covering to be used.

With slates (the only covering at present under consideration) the pitch may vary, according to the size of the slates, and the climate, as stated at page 142.

The steepest pitch there mentioned is, however, very seldom used for iron roofs, and in many cases where such roofs are erected—over railway stations, sheds, or other places where a slight leak is not of much importance, the slope is for economy made rather flat, 21° or 22° being a very common pitch for roofs covered with ordinary slating. Large slates are of course to be preferred for these flatter roofs, and “Duchesses” are very often used for the purpose.

PROPORTIONS OF TRUSSED RAFTER ROOFS (see Fig. 240) from 20 to 45 feet span.¹ Rise = $\frac{1}{8}$ span. Camber of tie rod $\frac{1}{30}$ span.

Span in feet.	Rafter T iron. Dimensions in inches. R	Diameter of Tension Rods in Inches.		
		Between heads of Struts. X	Between head of Strut and foot of Rafter. Z	Between head of Strut and apex of Roof. Y
20	2½ by 2 by ¾	¾	¾	¾
25	2½ „ 2 „ ¾	¾	1	¾
30	2½ „ 2½ „ ¾	2½ by ¼	2½ by ¾	2½ by ¼
35	3 „ 2½ „ ¾	2½ „ ¾	2½ „ ¾	2½ „ ¾
40	3½ „ 3 „ ¾	2½ „ ¾	2½ „ ¾	2½ „ ¾
45	4 „ 3½ „ ¾	3 „ ¾	3 „ ¾	3 „ ¾

PROPORTIONS OF WROUGHT-IRON QUEEN-ROD ROOFS (see Fig. 242), from 20 to 40 feet span, usually adopted in practice.² Rise = $\frac{1}{8}$ to $\frac{1}{4}$ of span. Camber of tie-rod = $\frac{1}{40}$ to $\frac{1}{15}$ of span. Distance apart of Principals, 6 or 7 feet.

Span of Roof in feet.	Tie Rod, diam. of, in inches. T	King Bolt, diam. of, in inches. KB	Queen Bolts, diam. of, in inches. QB		Struts of T iron. S			Rafters of T iron. R			
			1st Pair.	2d Pair.	No.	Depth in inches.	Sectional area of top table in inches.	Sectional area of web in inches.	Depth in inches.	Sectional area of top table in inches.	Sectional area of web in inches.
20 to 25	1	¾	¾		2	2	0.4	0.5	3	0.6	1.1
25 to 30	1½	¾	¾		2	2	0.5	0.6	3	0.9	1.1
30 to 35	1½	¾	¾		4	2½	0.5	0.9	3	0.9	1.1
35 to 40	1½	1	¾		4	2½	0.7	0.9	3½	1.2	1.6

Note.—The tie rod may be reduced from the ends to the middle $\frac{1}{4}$ inch in diameter for each division of the tie rod formed by the queen bolts.

General Remarks.—Some general remarks on iron roofs—on the precautions to be taken to prevent the evils caused by contraction and expansion under changes of temperature, and on other points relating chiefly to roofs of large span—will be found in Part II.

¹ From Molesworth's *Pocketbook of Engineering Formulae*.

² From Hurst's *Architectural Surveyor's Handbook*.

CHAPTER IX.

S L A T I N G.

Pitch.—The general question of the proper "*pitch*," or inclination for different roof coverings, will be entered upon in Part II.

As this course refers only to slating, it will be sufficient here to state that experience shows the proper pitch for slates of different sizes to be as follows:—

	Inclination of Sides of Roof to Horizon.	Height of Roof in parts of Span.
Large slates . . .	22°	$\frac{1}{8}$
Ordinary slates . . .	26½°	$\frac{1}{4}$
Small slates . . .	33°	$\frac{1}{3}$

The more severe the climate, and the smaller and lighter the slates, the steeper should be the roof, otherwise the wind will lift the slates and blow the rain up under them. A high roof, however, is of course more expensive, as it contains for the same span more timber and more surface to cover than one of flatter pitch.

Slates are laid either upon boarding or battens.

Boarding costs more than battens, but keeps out the wet and heat better, and is almost necessary for light slates.

Battens may be used for heavy slates, and are nailed upon the rafters at a distance apart equal to the "gauge." (See p. 144.)

The scantling of the battens used with rafters 12 inches apart varies from 3 inches by 1 inch for large slates to 2½ inches by ¾ of an inch for the smaller sizes.

Names of Parts.—The "*back*" of a slate is its upper surface.

The "*bed*" is its under surface.

The "*head*" is the upper edge of a slate.

The "*tail*" is the lower edge.

The "*margin*" is the part of each course exposed to view on the outer surface of the roof.

The "*lap*"¹ is the distance by which each slate overlaps the next slate but one below it. This should never be less than

¹ *See Cover.*

$2\frac{1}{2}$ inches or 3 inches. The flatter the roof the greater should be the lap.

The "*gauge*" is the depth of the margin.

The "*lap*" and "*gauge*" are generally more accurately defined as follows:—

The "*lap*" is the distance between the tail of any course and the nail hole of the next course but one under it.

The "*gauge*" is half the difference between the length of the slate (measuring from the nail hole) and the lap.

For example, with "*ladies*" = (16" × 8") nailed at the head, as shown in Fig. 256, $\frac{15 \text{ in.}^* - 3 \text{ in.}}{2} = \frac{12 \text{ in.}}{2} = 6$ inches (the gauge); with "*countess*" slates (20" × 10") similarly nailed, $\frac{19 \text{ in.}^* - 3 \text{ in.}}{2} = \frac{16 \text{ in.}}{2} = 8$ inches (the gauge).

The last-mentioned definition of lap and gauge refers, however, only to slates nailed near the head (see Fig. 255). When slates are nailed near the centre (see Fig. 257) the lap is the distance between the tail of any course and the head of the course next but one below, and the gauge is equal to half the difference between the lap and the full length of the slates.

Thus with countess slates, 20 inches by 10 inches, nailed near the centre, the lap being 3 inches, the gauge is $\frac{20 \text{ in.} - 3 \text{ in.}}{2} = \frac{17 \text{ in.}}{2} = 8\frac{1}{2}$ inches.

Preparing and Laying Slates.—The slates are first carefully squared to size, except the heads, which may be left rough, but not concave, the edges straightened, each punched with two nail holes, and the whole sorted, if necessary, into three thicknesses.

In laying the slates the great object to be attained is that the bottom edge, or "*tail*," of every slate should fit as closely as possible to the backs of those immediately below it; they should therefore be laid (except the lower slates of the doubling courses) with their smooth sides downwards. The sections of the slates will therefore be as shown in Fig. 256—the bed being a little longer than the back, and the edges ragged and splayed; but they are generally drawn square-edged, as in Fig. 258 and others. The vertical joints between the slates should be as close as possible, and each should fall on the central line of the slate below.

In good slating, the vertical joints of the alternate courses should range in straight lines from ridge to eaves, and the tails of the slates should be in perfectly straight horizontal lines.

* One inch is deducted from the full length of the slate, being the distance from the nail hole to the head.

NAILING SLATES.—There are two methods of nailing slates, which differ very considerably, and will each be described separately.

Nailing near the Head.—In this method the nail holes are

Fig. 255.

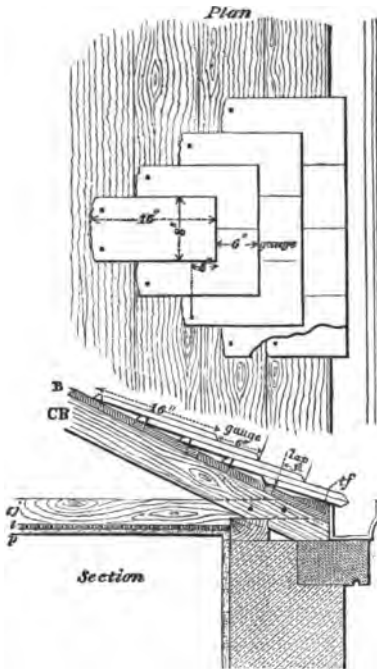

Fig. 256.

N.B.—The thickness of the slates in this and other figures is exaggerated.

Nailing near the Centre.—In this arrangement the nail holes are placed near the centre of the slate, at a distance from its tail equal to a little more than the gauge + lap, so as to clear the head of the slate below.

This is a plan of more recent introduction than the other, and is preferable for large slates, as from the position of the nails the wind acts upon the slates with a leverage of only about half their length. Moreover, the slating so laid is easier to repair. It is, however, objected to by some, as the breakage of one slate exposes the nail of the slate below to the weather, and opens a direct communication with the roof through the nail hole.

With the same size of slates and same nominal depth of lap,

pierced at about an inch from the head of the slate, and the tails of the next course but one above override the nail hole by the specified "lap."

This plan used to be universally adopted, and is still in vogue, especially for very small slates.

It is preferred by some, because there are two slates over every nail hole, so that, when a slate is broken, the nail below is still covered by one slate, and thus protected from the weather. On the other hand, however, when the slate is nailed near the head, the wind acts upon it with a leverage equal to nearly its whole length, and this makes a considerable difference if the slate is large.

Common or small slates secured with one nail only are necessarily fastened in the centre of the head.

the gauge is, under this arrangement, wider than when the slates are nailed at the head; it is therefore evident that fewer slates are required to cover the same area, and that this plan of nailing is more economical than the other. The so-called three-inch lap is, however, in this case really only barely 3 inches, whereas in the other method it is practically 4 inches.

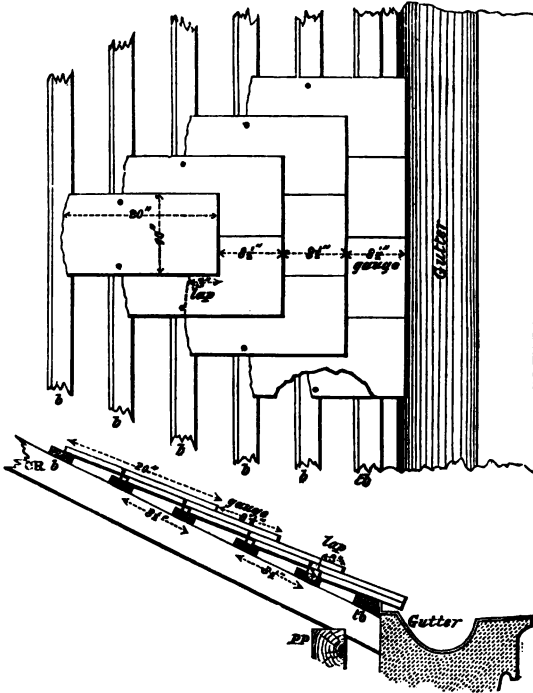

Fig. 257.

Fig. 258.

In the best work slates are secured with copper nails, but zinc and "composition" nails are sometimes used, or simply iron nails dipped in boiled oil to preserve them from corrosion.

The nails should be proportioned to the size of the slates, both in length and stoutness, and should have large heads, thin and flat, so that they may not prevent the slates from lying close.

In good work every slate should be secured with two nails, and in exposed places three have been used, though in very common work one nail only for each slate is often permitted.

In nailing care should be taken not to bend or strain the

slates, or they will crack, and fly under sudden changes of temperature.

EAVES AND RIDGE COURSES, etc.—If the slates vary greatly in size they should be assorted in lots, and the breadth of the courses decreased gradually from the eaves upwards.

The thickest slates should be in the lowest courses.

The lowest course of all, called the "*doubling eaves course*," is laid with a double layer of slates, the lower one being cut so as to be about one inch longer than half the length of the uncut slates. The highest or "*ridge course*" is also a double one. The slates in these courses are nailed near the head.

The eaves course is supported and the tails of the slates kept well up by a wedge-shaped board called a "*tilting fillet*"¹ (*tf*, Fig. 256), or "*eaves board*." This prevents any open space occurring under the tails of the slates into which the wind could penetrate so as to loosen the slates and make them rattle. When battens are used the effect of the tilting fillet is produced by a "*tilting batten*," thicker than the others. (See *tb*, Fig. 258.)

In the hips and valleys the slates have to be cut off obliquely to fit the angles; in the angles of valleys, and also where walls, chimneys, or windows cut into the roof, they have their sides slightly raised by means of tilting fillets running parallel to the valley. (See Fig. 274.)

HIPS AND RIDGES are frequently covered with lead, as described at p. 165.

SLATE FILLETS are sometimes used to cover ridges. They are nailed on to the head of the ridge piece, so as to project and cover the joint between its sides and the top course of slates, the space between the under side of the fillet and the slates being pointed in cement.

SLATE RIDGING consists of a roll and sides formed out of thick slate. There are various patterns connected in different ways, which cannot here be described.

A common form in which the roll and one wing are in one piece is given in Fig. 259.

Another form having the roll and wings in separate pieces, the two latter being secured together with copper screws, is shown in Fig. 254.

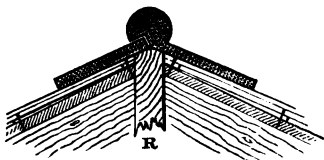

Fig. 259.

¹ Sc. *Doubling*.

The top of the ridge piece is kept higher than the slates in order that it may be bevelled off to receive the ridging.

Slate ridging is generally somewhat twisted, and very difficult to keep in straight lines when laid in long lengths.

TILE AND POTTERY RIDGING is frequently used with slates, especially with those of a coarse description. It is similar in form to slate ridging, but the roll and wings are always in one piece. The ornamental cresting may be detached, fitting into a groove in the roll.

SLATING FOR IRON ROOFS.—In covering iron roofs the slates may be laid on boarding or battens, or upon angle-iron laths filled in with wood and fixed at the proper gauge, in exactly the same way in which they are laid on wooden roofs.

When it is wished to make the roof fireproof the woodwork may be entirely dispensed with by laying the slates directly upon iron laths (as in Fig. 245), to which they are secured by copper nails or wire bent round the laths, by copper or zinc clips, or by leaden pegs.

SHOULDERING.—In exposed situations, especially when the slates are rough, their heads are imbedded for a width of about two inches in hair mortar, mixed with ashes (so as to resemble the slates in colour). This is termed "shouldering." It keeps the slates down tight at the tails, and effectually prevents the wind from penetrating.

RENDERING.—Slates laid on battens are frequently rendered all over the under side with lime and hair. This may be done even when the roof is boarded, in order to give the slates a firm bed and to enable them to withstand traffic over them.

TORCHING.—Sometimes the slates are laid dry, and the joints between the tails of one course and the heads of another are afterwards pointed from the inside with hair mortar; this, however, does not last long under changes of temperature.

The boarding is frequently covered with felt, which delays the passage of heat and cold, and keeps the roof dry in case of defects in the slating. It is a good plan to fix battens upon the felt, to which the slates may be secured, so as to have a circulation of air just above the felt, which preserves it from decay.

TABLE showing the SIZES and WEIGHTS of SLATES and the numbers required for ROOFING.¹

Name of Slate.	Size.	Gauge for 3 inch lap nailed in centre.	Number of squares covered by 1200.	Weight of 1200. 1st quality.	Number required to cover one square.	Weight per square. 1st quality.	Nails required per square.	
							Iron.	Copper.
	Inches.	Inches.		Cwts.		Cwts.	Number	lbs.
Singles ² . . .	12 by 8	4½	2·8	17½	430	6¼	860	5
Doubles . . .	13 by 6	5	2·5	15	480	6	960	6
Ladies (small) . . .	14 by 12	5½	5·0	31	240	6½	480	3½
Do. (large) . . .	16 by 8	6½	4·¾	25	300	5½	600	3½
Viscountesses . . .	18 by 10	7½	6·0	36	200	6	400	2½
Countesses . . .	20 by 10	8½	7·0	40	171	5¾	342	4
Marchionesses . . .	22 by 12	9½	9·4	55	130	6	260	3½
Duchesses . . .	24 by 12	10½	10·0	60	125	6	250	3
Princesses . . .	24 by 14	10½	12·¾	70	94	5½	188	3
Empresses . . .	26 by 16	11½	15·¾	95	79	6½	158	3½
			Squares Covered by 1 ton.					
Imperials . . .	30 by 24	13½	2·5	...	48	8	96	3
Rags . . .	36 by 24	16½	2·2	...	40	9	80	3½
Queens . . .	36 by 24	16½	2·5	...	40	8	80	2

WYATT'S PATENT SLATING consists of very wide slates, laid without boards from rafter to rafter, the lap being as usual, and the side joints being covered with narrow slips of slate bedded in putty.

Such slating may be laid at an inclination as flat as 10°; it is not often used, and is liable to injury from expansion and contraction, also from the slightest settlement in the roof, and from the falling out of the putty.

SLATE SLABS have also been laid in a similar manner, they save the expense of boarding, but are very heavy, costly, and easily broken.

A very economical system of slating with large slates is as follows:—The rafters are placed at a clear distance apart about 1½ inch less than the width of the slates. Down the centre of each rafter is nailed a fillet, thus forming a rebate on each side, in which the edges of the slates rest, being secured by black putty, or—as this looks smeary and uneven—by a second fillet 2 inches wider than the first, nailed over it so as to cover the edges of

¹ From Hurst's *Arch't. Surveyor's Handbook*, Gwilt's *Encyclopædia of Architecture*, and Seddon's *Notes on Building Trades and Building Construction*.

² Also called *Smalls*.

³ Slates of inferior quality are thicker and heavier.

the slates and hold them down. Each slate laps about 3 inches over the one below it; only half the number is required in this as compared with the ordinary method of slating, and no boarding or battens are necessary.

ORNAMENTAL SLATING.—Slating is sometimes laid in patterns, and also lozenge-wise—that is, with the angles up and down, but this latter arrangement forms a less durable covering than the ordinary method.

OPEN SLATING¹ is sometimes used for sheds or other inferior buildings.

The slates, instead of being laid with close side joints, are about $1\frac{1}{2}$ inch to 2 inches apart. This requires only about $\frac{2}{3}$ the number of slates used for the ordinary method, and keeps out the wet sufficiently for very common purposes.

¹ Sometimes called *Half-Slating*.

CHAPTER X.

PLUMBERS' WORK.

THE work of the plumber includes laying sheet-lead or zinc¹ on roofs and "flats," forming gutters and flashings, lining cisterns, fixing pipes and fittings for water supply and other purposes, also pumps, baths, water-closets, etc.

Laying Sheet Lead.—The surface to be covered with sheet lead is generally boarded. It should be perfectly smooth, even, and the boards thick enough to prevent their warping, otherwise the lead is liable to be damaged by the sharp edges of the boards.

All sheet lead should be laid with a "current" or slope to throw off the water.

The amount of inclination varies according to circumstances; in gutters it must depend greatly upon position, and the space available for the fall. In any case, the current should not be less than 1 inch in 10 feet ($\frac{1}{120}$), but on flats, where there is no difficulty, it may be made 3 inches in 10 feet.

In order to guard against the effects of contraction and expansion in large pieces under the influence of changes of temperature, nothing larger than a quarter of a sheet—that is, a piece about 10 feet by 3 feet—should be used.

For the same reason, sheets of lead should on no account be rigidly fixed on both sides, nor should they be soldered to one another.

The joints necessary between adjacent sheets are made in various ways, so as to allow sufficient play for contraction and expansion.

The joints in the direction of the "current" are made with "*rolls*" or "*seams*" while "*drips*" are used for those joints which run across the current.

Fig. 260 is the plan of a portion of two roofs arranged so as to show a lead flat, a valley with trough gutter between the

¹ The description of the method of laying zinc forms a part of the Advanced Course and will be given in Part II.

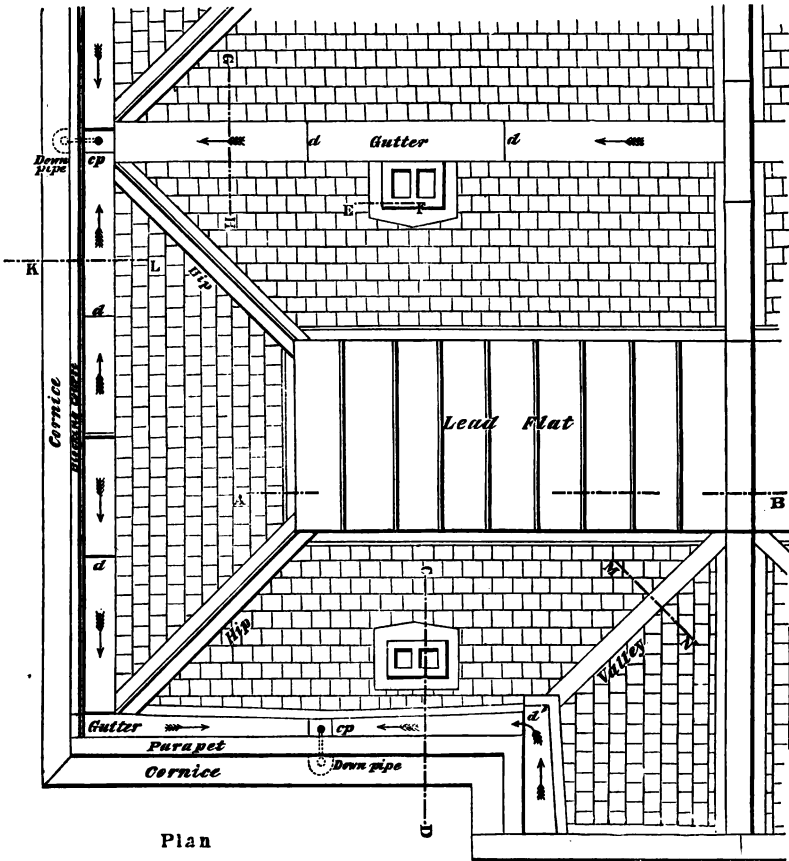

Plan

Fig. 260.

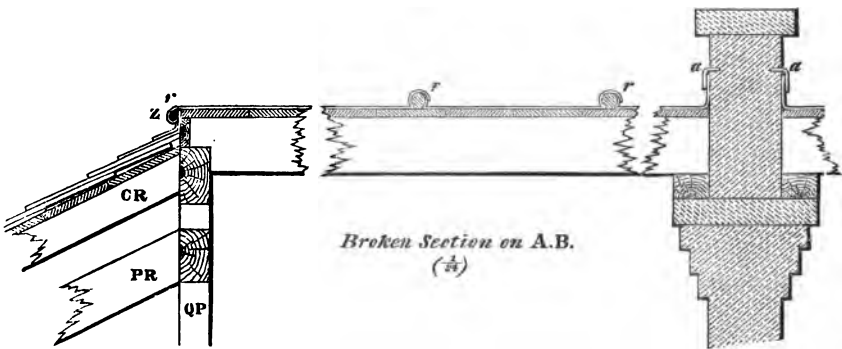

Fig. 261.

roofs,¹ a gutter behind a blocking course, also one behind a parapet wall, a valley in the angle formed by two portions of one roof,² together with hips, chimney and gable flashings, cess-pools, drips, etc.

The subsequent figures, 261 to 274, are sections on the lines marked and lettered on Fig. 260, giving details, showing how the lead is fixed in the different parts of a roof.

Rolls are joints between two sheets on a flat (*rr*, Fig. 261), formed by fixing under the junction of the sheets a piece of wood about 2 inches diameter, having its upper surface rounded and the



Enlarged Section of Roll

Fig. 262.

lower corners either left square, or chamfered off as shown in Fig. 262.

This wooden roll is overlapped by the edges of the adjacent sheets.

One of these is hammered and dressed closely in to cover the roll,

reaching as far as the crown, and the edge of the other sheet is then beaten and dressed down over the first, as shown.

The laps should be on the least exposed side of the rolls, so that the wind may not blow the lead up. The rolls should be about 2 feet apart.

In many cases the inner sheet is dressed right over the roll down to the flat on the other side. This is a waste of lead, and is injurious to the work, for it confines the sheet so much that it cannot expand and contract under changes of temperature.

The outer sheet is also frequently continued right over the side of the roll and doubled down, so that about an inch or more lies upon the flat. This is intended to make the joint more secure, but is objectionable, not only because it confines the lead, but also because the water lying upon the flat gets in between the sheets of lead and is drawn up by capillary attraction, so as to pass the joint and soak into the wood rolls and boarding.

HOLLOW ROLLS are in some parts of the country³ preferred to those with the wooden roll or core.

The ends of two adjacent sheets are turned up against one another as at O (Fig. 263) the upper edge of one being bent down over the other; the two are then bent over together to form a roll as at P.

¹ *Middle Gutter.*

² *Sc. Flanks.*

³ Chiefly in Scotland and the north of England.

Between the ends of the two sheets so treated is a "tingle"¹ (shown in Fig. 263 by a thick line). This is a narrow strip of lead, of which about 2 inches is nailed to the boards, being let into a groove formed in them to receive it.

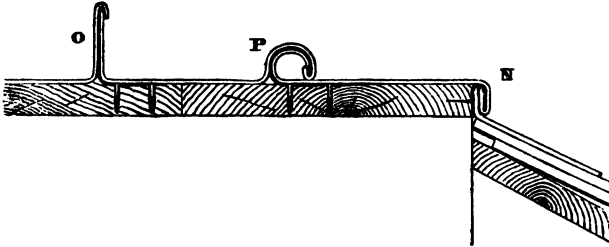

Fig. 263.

Similar tingles are fixed at intervals of about 2 feet throughout the length of the rolls, and, being turned over between the ends of the sheets in forming the rolls, secure the latter firmly to the boarding.

The ends of the hollow rolls are dressed over the *nosings* forming the sides of the flat.

Nosings are rolls formed at the angle between the horizontal surface of the flat and the sloping sides of the roof.

The upper half course of slates is first covered by a flashing, which is dressed about 8 inches upon the slope, turned up, and terminated at the angle of the flat. Upon this is secured a wooden roll, undercut on the lower side, as shown at Z, Fig. 261. Over the roll the lead of the flat is dressed in a manner similar to that above explained.

Occasionally the roll at the edge of the flat is formed with its base upon the top of the boarding in the same way as the other rolls on the flat. This is considered by some to have a better appearance than the nosing, as it forms a sort of ridge which ranges with the ridges of the hips of the roof.

Hollow Nosings may be formed on the same principle as hollow rolls (see N, Fig. 263.) This figure shows a flat nosing, but they are often made round or "*bottled*" for the sake of appearance, being then in section like the roll P, but with the base vertical.

Seams are formed by bending up the adjacent edges of two sheets—turning one over the other, and then dressing them down close to the flat.

¹ Sc. *Latchet* (see page 160).

They take up less room than rolls, but do not form so good a joint.

Lapped Joints are those in which one sheet is dressed down flat and the edge of the adjacent sheet over it, so as to lap from 4 to 6 inches.

This joint is used chiefly between the different portions of long and narrow pieces of lead, such as flashings, coverings for hips, ridges, valleys, etc.

Drips are joints made across the current of a sheet of lead, thus:—

The surface to be covered is interrupted by steps from $1\frac{1}{2}$ to 3 inches in depth (the deeper the better), running across it at intervals of about 8 or 10 feet. The lower sheet is first laid, dressed close up to and over this step, its upper edge fitting into a rebate cut for it in the boarding of the higher level of the gutter.

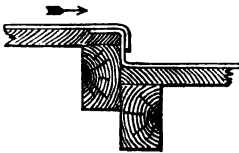

Section of Drip
Fig. 264.

The upper sheet overlaps the lower, and is turned down over it as shown. This upper sheet should stop short of the horizontal sheet below, otherwise the wet will be drawn up, by capillary attraction, between the sheets into the boarding above.

Five drips are shown at *dd* in the gutter, Fig. 260, and Fig. 264 represents a section of one of them; the arrow shows the direction of the flow of water.

BOTTLENOSE DRIPS.—In some parts of the country a drip, such as that in Fig. 264, is formed thus:—The boarding on the upper level is allowed to project an inch or so over the bearer; the lower sheet of lead is turned up until it reaches the lower side of this projection, or “bottleneck;” the upper sheet is dressed round the projection, and hangs down over the turned-up lead, to form the apron.

Fixing Lead to Masonry.—A RAGLET is a groove about an inch deep, and as narrow as possible, cut into masonry or brickwork to receive the edge of sheet lead to be fixed to the walls.

WEDGES, WALL-HOOKS.—The lead may be secured in several ways—by wooden or lead wedges¹ driven in tight between it and the edge of the raglet, or by wall hooks,² which are short pins with thin flat heads on one side, at right angles to them. The lead wedges are more adapted for use in stone work, and the wall hooks in brick work.

¹ *Sc. lead bats.*

² *Sc. Thumbnails.*

The joint is generally pointed and made good with cement or mastic.

BURNING IN.—When the raglet is formed along the top of a course, as shown in Fig. 270, and a very secure joint is required, to withstand exposure, the lead may be “burnt in,” which consists in inserting the edge of the sheet in the raglet groove, and filling the latter with molten lead, which is then well punched or “caulked” in.

Lead Dots.—In some cases—for example, in covering a small dome with sheet-lead—it is necessary to screw the lead to the woodwork. The screws are generally used in pairs, inclining inwards toward one another, and the boarding is countersunk, so that the heads of the screws are well below the surface of the wood. Into the hollow thus formed, the sheet-lead is dressed and screwed down, and then a patch of molten solder (a *lead dot*) is poured in, so as to protect the screws, and bring the whole to an even surface. If the boarding is not hollowed out where the lead dots occur, they, of course, project above the surface. The heads of nails may be similarly protected.

Flashings are pieces of sheet lead placed so as to cover joints which would otherwise admit wet to the roof timbers, or other parts of the building.

The term is frequently applied to a piece of sheet lead fixed to a wall, and *hanging over*, so as to cover the edge of a gutter or other sheet lead turned up against the wall, and to protect the joint between the lead and the masonry (See *aa*, Fig. 265.)

In some parts of the country, however, this particular flashing is known as an “*apron*,” and as such a distinction serves to prevent confusion, it will be adopted in these notes.

The term “*flashing*” will be taken, therefore, to include the whole of the lead used for the protection of a joint, and “*apron*” to refer only to the overhanging piece.

The flashings principally required in a building are over the joints formed where a roof is cut through by a wall, chimney, skylight, or dormer window.

The flashing may be fixed in various ways; it may lie over the slates as in Fig. 267, or under them, as in Fig. 268.¹

The portion turned up against the wall should be 5 or 6 inches high, and may itself be secured in a raglet, or the turned-up end may be left free, so as to allow contraction and expansion, and be covered by an apron.

¹ This kind of flashing may be considered a form of gutter.

AN APRON is a covering piece of sheet lead, of which the upper edge is turned into a raglet, and there secured as above described. The remainder is turned down, and hangs freely over the upright part of a flashing or gutter.

Fig. 265.

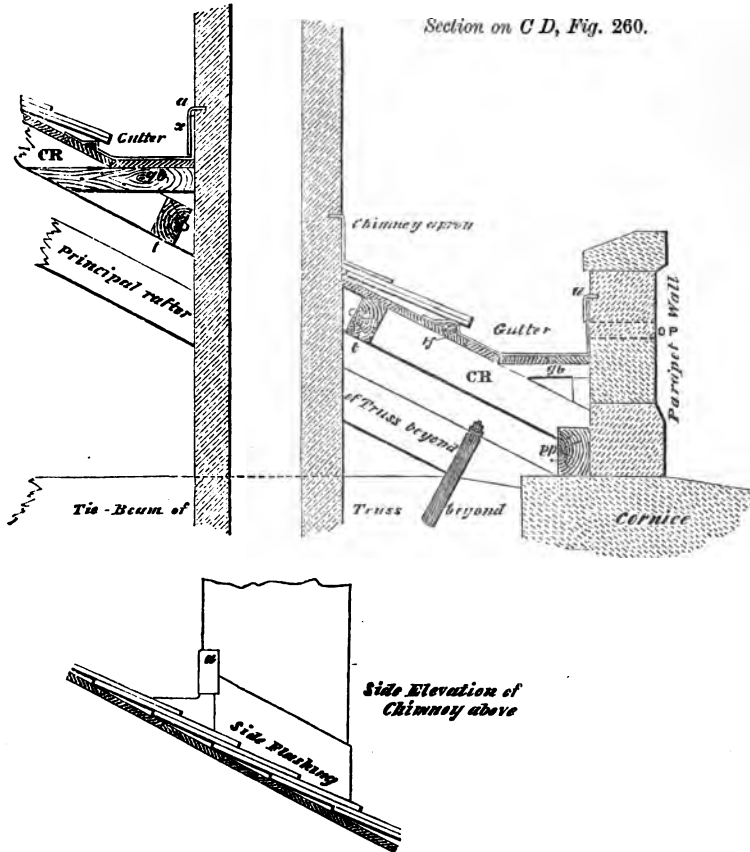

Fig. 266.

When the side or end of a gutter or flat is turned up against a wall, the joint between the wall and the upturned lead is thus securely covered and protected from wet, while the lead is free to expand and contract under changes of temperature.

In the best work, sheets of lead which are wide, or of which the outer edge is fixed, should never themselves be secured to the wall, but should be connected with it by means of an apron.

Some authorities recommend that the apron should be of the same width as the upturned lead, as shown at *x* in Fig. 265, so that it may not be liable to be blown up and expose the joint; this, however, is generally considered a waste of material, and it is objectionable, for it leads to the sucking up of moisture past the joint by capillary attraction. The apron is therefore usually turned down only 3 or 4 inches over the edge of the upstanding lead, so that the lower edge may be clear of any wet which lies upon the horizontal sheet of lead below.

CHIMNEY APRON.—The flashing between a wall or the side of a chimney and the roof that slopes down from it is also frequently called in England an "apron," and in Scotland a "berge."

It is a simple flashing, formed out of lead some 15 or 16 inches wide, of which 6 or 8 inches may be dressed over the slates down the slope, 6 inches upturned against the chimney, and the remainder fixed in the raglet.

HORIZONTAL FLASHINGS.—When a joint occurs between a horizontal surface, such as a lead flat, and a wall or chimney, the lead is dressed up against the masonry to a height of from 5 to 7 inches, and the joint covered by an apron, as at *a* in Fig. 261.

RAKING FLASHINGS are required to cover the joint which exists where the slope of a roof is cut into by a wall or chimney.

There are two methods of arranging the flashing. The arrangement about to be first described is the more common in England, and the second in Scotland.

1. The strip of lead required should be about 16 inches wide; of this, 8 inches lie¹ upon the slates; 6 inches are turned up against the masonry, and the remainder into a raglet parallel to the slope, and secured there.

A tilting fillet² is fixed in the angle formed by the wall and roof boarding, which raises the sides of the nearest slates, so as to throw off the water.

The section, Fig. 267, shows this arrangement; it is taken through the lap of the slates where there are, of course, three layers.

An additional precaution is sometimes taken by forming a

¹ This is when countess slates are used. The width should be 3 inches more than half that of the slate, so as to overlap the first side joint 3 inches.

² Sc. *Doubling*.

cement fillet, of triangular section, under the lead flashing in the angle between the slate and the wall, so that if the flashing is blown up, the joint is still kept secure until the lead is replaced.

2. In the second method the tilting fillet is placed from 2 to 4 inches from the chimney or wall, and the lead dressed close over it, turning up against the wall and into the raglet as before. The slates lie over the lead.

In superior work, the upturned lead, instead of being secured in the raglet, is free, and covered by an apron.

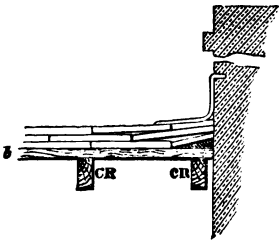

Section on E F, Fig. 260.

Fig. 267.

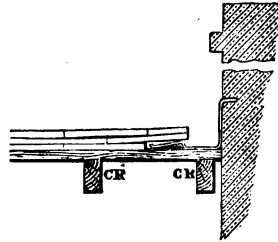

Section on E F, Fig. 260.

Fig. 268.

Fig. 268 gives a section (taken through the lap of the slates) of this method as generally carried out. It will be seen that it virtually forms a sort of gutter down the side of the chimney, and it is sometimes so described. This arrangement requires a little more lead than the other, but secures it better, for the lead, being under the slates, is not liable to be blown up. The wind is apt, however, to catch the exposed sides of the slates, and displace them. The remedy for this is to continue the slates right over the gutter until they nearly touch the chimney. When this is done, not only are they themselves protected from the wind, but they keep the sun off the lead, and prevent the latter from cracking.

The disadvantage of the arrangement last described is that when the gutter is covered by the slates its interior cannot easily be cleared out, and it becomes choked with dust and dirt, which lead the wet over the tilting fillet and lead into the roof boarding.

An elevation of a raking side flashing for a chimney is given in Fig. 266.

STEPPE^d FLASHINGS are often used where large and wide chimneys, or gable walls, cut into the slope of a roof.

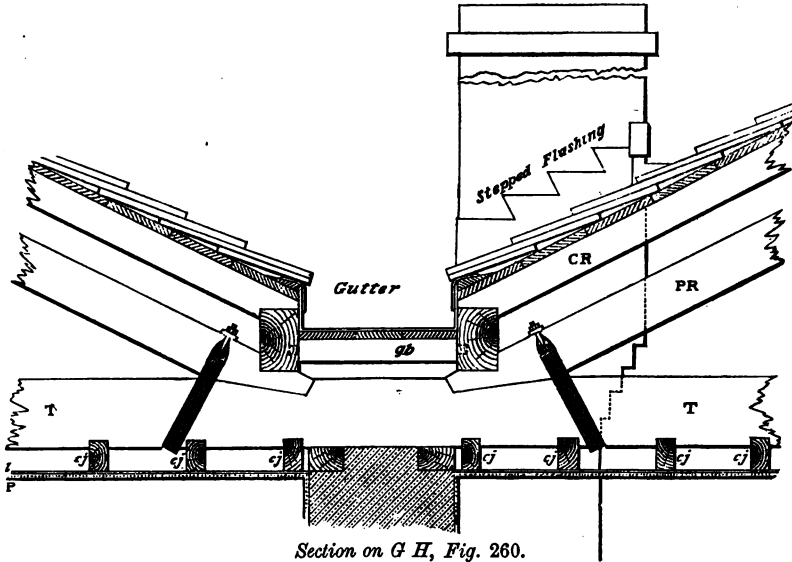

Fig. 269.

The raglet, instead of running parallel to the slope of the roof, is in short horizontal lines, and the lead is cut into steps, the ends of which are at right angles to the slope, as shown in Fig. 269.

This is a great advantage in brick work, as it enables the raglet to be formed by raking the horizontal joints, instead of cutting into the bricks.

There are several ways of fixing stepped flashing.

The most common is to use lead some 16 inches wide, of which 8 inches may lie on the slates, 6 or 7 inches turn up against the wall, and the remainder into the raglet.

The section in this case would be similar to Fig. 267, and the elevation as in Fig. 269, except that the edge of the lead lying upon the slates would be seen.

Another plan is to form a side gutter along the wall, as in Fig. 268, securing the upturned lead in a stepped raglet, or covering it by an apron all in one piece cut to fit the steps,¹ as shown in elevation Fig. 269.

¹ Sometimes called a *Skeleton Flashing*.

A better flashing is formed by hanging the stepped apron in pieces, one to each step, so arranged that the broad end of each piece overlaps the narrow end of the piece next to it, down the slope, by 2 or 3 inches. These pieces may have a mean width of about 5 inches, of which an inch is secured in the raglet, and the remainder hangs over the flashing. The flashing itself will be disposed, as in Fig. 268, over a tilting fillet under the slates; the upturned portion need not be more than 3 or 4 inches high, and will be covered by the stepped apron.

Step flashings fixed with an apron are good for masonry as well as for brick work.

SOAKERS¹ are used instead of stepped flashing, and consist of pieces of lead worked in between the slates as they are laid; each piece is the length² of a slate, and about 14 inches broad, so that 6 to 8 inches may be under the slate, and 4 to 6 inches up against the wall, being covered by an apron.

This form of flashing is now in very general use. It is simple and secure; the lead cannot be stripped off without removing the slates.

TINGLES³ are fastenings placed at short intervals to prevent exposed sheet-lead—such as flashings which lie upon the slates' head upon ridges, etc. etc.—from being blown up by the wind. They consist of strips of sheet-lead which are nailed to the boarding, or hooked on to the head of a slate, and bent over so as to clip the edge of the flashing.

Lead Gutters.—Two or three methods of constructing lead gutters are illustrated in Fig. 260, and the details connected therewith.

All gutters should have a current or fall of at least $\frac{1}{100}$, and the joints between the ends of the sheets should be formed, when possible, by drips not more than from 8 to 10 feet apart.

The sides of gutters which abut upon walls or blocking courses should be turned up from 6 to 7 inches against them, and be covered by an apron. The side is, however, frequently fixed by simply turning its upper edge into a raglet; as the other edge is trammelled by the tilting fillet, this prevents free expansion and

¹ Often also called stepped flashing.

² Very frequently the soakers are made, for economy, only about 4 inches longer than the gauge of the slating, so that each covers the exposed portion of a slate, and laps 4 inches over the next piece.

³ Sometimes called Bale Tacks. Sc. *Latchets*.

contraction under changes of temperature, and often results in splitting the lead. The ends of lead gutters are either *bossed up*—that is, neatly beaten into shape—or else formed with *dog-ear joints*, the lead being folded like the end of a paper parcel.

BRIDGED GUTTERS are formed with sheet-lead laid upon boarding, supported by bearers. These bearers may either be framed in between the timbers of the roof or merely nailed to them. In the former case they are called *trough* or *framed gutters*; in the latter case *V gutters*.

Trough¹ or Parallel Gutters.—Fig. 269 (being a section on A B of Fig. 260) shows a trough gutter formed in the valley between two roofs.

It consists of a gutter bearer (*gb*) framed in between the pole plates of the roof, which are placed upon the rafters, so as to afford room for the gutter.

Boarding is fixed upon the gutter bearer, and upon this is laid the lead which passes up the slope on each side, and over the tilting fillet under the slates.

When a gutter is very deep and wide, so as to require a great width of lead, the sides sometimes stop short before they turn up the slopes of the roof, and are covered by an apron on each side hanging over the end of the rafter and the pole plate, as shown in Fig. 269.

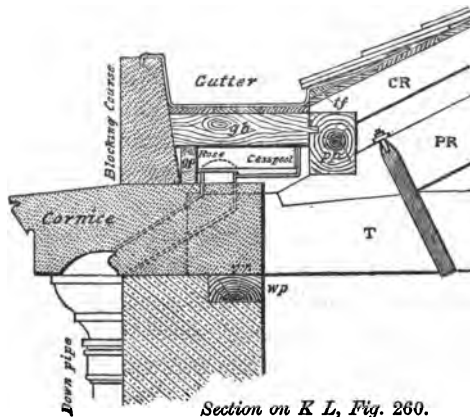

Fig. 270.

A trough gutter fixed behind a blocking course is shown in Fig. 270, which is a section on K L, Fig. 260.

¹ Sc. Box Gutter.

The bearer is framed at one end into the pole plate of the roof, the other end being supported by a gutter plate, *gp*.

One side of the gutter lead is turned up against the blocking course, and may be secured, as shown, by turning it into a raglet on the top.

It may, however, be covered by an apron, either similarly secured (see Fig. 131), or continued over the top of the blocking course and turned down about an inch over the front edge. In the last case the apron is kept in position by a conical-headed rivet leaded into the top of the blocking course.

The inner edge of the lead is turned up over the tilting fillet and boarding of the roof until it is higher than the top of the blocking course (or than the overflow pipe, if any), so that, in case the gutter should be choked, the water may flow over or through the blocking course, not over the inside into the building.

When the blocking course is high an overflow pipe may be introduced, as in Fig. 265.

It is evident that the necessary fall for a trough gutter may be obtained by lowering the bearers gradually along its length, the width remaining the same throughout. The section, Fig. 270, is taken at a high part of the gutter, and the bearer is nearly up to the top of the pole plate; but in Fig. 269, which is a section at a lower point of the valley gutter, the bearer is nearly at the foot of the pole plate.

V Gutters.¹—An example of a V gutter formed behind a parapet wall, and also of one behind a chimney, is shown in Fig. 265, which is a section on C D, Fig. 260.

The gutter bearers, instead of being framed into the pole plate of the roof, as in the trough gutter, are here nailed to the sides of the common rafters.

The lead is arranged as before, about 4 to 6 inches being turned up against the inside of the parapet wall and covered by an apron.

As the parapet is generally of considerable height, an overflow pipe should be inserted, as at O P, so that, in case of the gutter being flooded, the water may escape through the wall and not into the roof.

The end of the lead turned up the roof should be at least as high as this overflow.

The necessary fall for a V gutter is obtained by lowering the

¹ This name is sometimes applied to common arris gutters, formed with two boards fixed together at an angle.

bearer. It will be noticed that, as this brings it farther down into the angle between the slope of the gutter and the parapet wall, it has the effect of narrowing the gutter, which tapers in plan from the highest to the lowest level (see Fig. 260).

In arranging such a gutter, therefore, the points of exit for the water should be as frequent as possible, in order to avoid long lengths of gutter, for these spread out as they rise till they become very wide, and require a large quantity of lead. It will be noticed also, that as each drip raises the level suddenly, it has the effect of widening the gutter at the point where it occurs. An illustration of this is shown at *d'*, Fig. 260.

Fig. 265 shows a gutter formed at the back of a chimney where it cuts through the roof.

Such a gutter must be made of a size proportionate to the area of roof that drains into it.

It is constructed on the same principles as the ordinary **V** gutter, being higher and consequently broader in the centre, so as to throw the water off on each side of the chimney.

If the chimney be against a wall, the water must, of course, be thrown off to one side only, and the gutter is broader at the end next the wall.

The apron in Fig. 265 is shown the full depth of the upturned flashing as an illustration of the remarks at page 151.

Fig. 271 is a section of a **V** gutter formed between two roof slopes. The construction is similar to that just described, the fall being obtained by lowering the bearer. In the figure, the bearer is shown at the lowest point, and it will be seen that when it is raised to higher levels, in order to procure the necessary inclination, the gutter will be widened considerably.

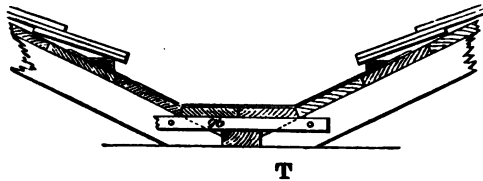

Fig. 271.

It is evident that troughs have great advantages over **V** gutters, inasmuch as they remain throughout of a constant width, and do not require a large, unsightly, and expensive width of lead.

Drips can be formed without widening the gutter, and down pipes are not required to be frequent.

STONE GUTTER LINED WITH LEAD.—Another form of gutter is that shown in Fig. 258, in which the lead is merely a lining to the gutter hollowed out in the cornice.

Such a gutter is very commonly used, especially in the North, but it is open to considerable objection. It is impossible, for want of depth, to form drips in the stone, and the lead must be in one long piece, composed of sheets soldered together, and liable to great contraction and expansion; or the joints between the sheets must be lapped, which makes the surface uneven and insecure.

Cesspools¹ are small cisterns formed in lead gutters at those points where it is intended to get rid of the water.

Fig. 260 shows two such cesspools, marked *cp* in plan. One of these is partly seen in elevation in Fig. 270.

The cesspool is a wooden box lined with sheet lead, turned up on all its sides, which are covered by aprons.

In the illustration given in Fig. 270 a channel is cut through the coping connecting the cesspit with the head of the down pipe. The mouth of this communication is protected by a perforated zinc rose or grating, to prevent dead leaves or rubbish from getting into and choking the down pipe.

Iron Gutters are cast by the founder, but the work of arranging them generally devolves upon the plumber.

EAVES GUTTERS² run along the lower edges of the roof slopes, and are fixed in different ways.

Fig. 224 shows semicircular gutters² resting on holdfasts nailed to the boarding of the roof. The ogee gutter in Fig. 230 is secured at intervals to the fascia board. The moulded gutter in Fig. 245 rests upon the wall, and that in Fig. 238 on a projecting sailing course or upon corbels.

This latter construction is to be preferred to that in Fig. 224, as, when repairs are required to gutters fixed to the roof boarding, the slates have to be torn up; moreover, the gutter resting upon the wall or sailing course is firmer, but care must be taken to weather the stone upon which it rests, outwards, so that in case of the gutter leaking, the wet may not enter the masonry.

IRON VALLEY GUTTERS are often used, and may be obtained either of sections like **V** gutters gradually varying in depth and

¹ *Sc. Drip Boxes.*

² *Sc. Rhones or Runs.*

width throughout their length, or of uniform cross section throughout like trough gutters.

The **V** gutters must of course be cast to suit the pitch of the roof, or the pitch arranged to suit such patterns as may be kept in stock.

Fig. 240 shows an iron trough gutter at the back of a parapet wall.

Zinc Gutters for eaves may be semicircular or moulded, and fixed in the same way as iron gutters; but zinc valley or trough gutters are laid somewhat in the same way as those of lead.

Down Pipes.¹—It has already been mentioned that all gutters should lead to vertical down pipes, which conduct the water to drains provided to carry it off.

These pipes are generally of cast-iron, circular in section, and about 3 or 4 inches diameter, the size varying according to the amount of water they will have to carry off.

They are secured by iron holdfasts, which clip the pipe, and are driven into the wall.

Zinc pipes, and even lead pipes, are similarly used, but they are not common, and need not further be noticed.

The openings into heads of all down pipes should be protected by a rose similar to that shown in Fig. 270, to prevent dirt and rubbish from getting in and choking the pipe.

Ridges and Hips.—The lead for covering these should weigh about 6 lb. per superficial foot. It has to a great extent been superseded by the use of slate and tile ridges.

Ridges on the apex of the roof are covered with lead laid over a wooden roll fixed to the ridge piece. This lead is dressed well into the angles under the roll, and laps over the slates on each side about 6 or 8 inches according to the size of the slates. It is generally left without any fastening, being kept down by its weight and the grip it has upon the under side of the roll.

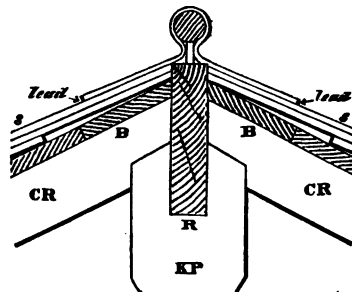

Fig. 272.

It may, however, in exposed positions be further secured by either

¹ Also called "Down-comers," "Stack Pipes," "Spouting," and "Rain Water Pipes." *See Conductors, Wall Pipes.*

of the following methods :—(1) by securing the lead to the sides of the roll with lead-headed nails; (2) by sheet-lead ears soldered to the under side of the sheet and nailed to the boards on each side of the roll; (3) by straps or tingles of stout lead laid at intervals along the ridge over the slates, and secured to the top of the ridge by the spike which carries the roll. The ends of these straps

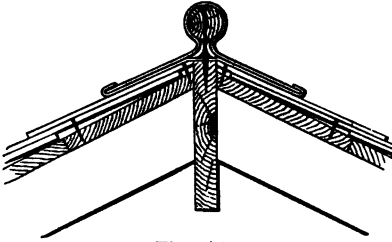

Fig. 273.

are bent back and dressed down upon the extremities of the sheet lead covering the ridge, as shown in Fig. 273.

HIPS, which are the salient angles formed by the meeting of two roof slopes (see Fig. 260), are covered with lead in the same way as ridges, except that, as the sheets have a tendency to slide down, they require to be nailed at the upper ends, the nails being covered by the lap of the sheet above.

The lead for covering hips varies from 18 to 20 inches in width, according to the inclination of the roof and the size of the slates.

VALLEYS.—In the valley formed by the intersection of two roof slopes forming a re-entering angle, such as that shown in Fig. 260, a strip of lead is laid on the boarding along the intersection of the slopes. The sides are turned up along the boarding for a distance of from 5 to 7 inches, and then dressed over tilting fillets¹ fixed parallel to the angle, so as to raise the sides of the adjacent slates.

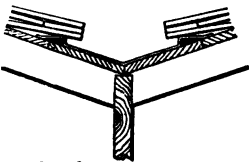

Section of Valley on M.M.

Fig. 260.

Fig. 274.

The joints between the different sheets necessary in a long valley are lapped for a length of 4 or 5 inches.

Substitutes for Lead Flashings.—Sheet zinc is frequently used instead of lead for the flashings of inferior buildings. It is laid nearly in the same manner, but not quite so easily, and does not last so long, especially in bad atmospheres.

Cement flashings, or rather "*filletings*," are used in the very commonest work. They consist merely of triangular fillets of cement worked into the angles of joints to be protected. Hair mortar is used for filletting in the same way as cement.

¹ Sc. *Doublings*.

Another form of cement flashing is thus constructed:—a row of nails is driven into the wall or chimney an inch or two above the joints to be protected. Round these is twined tarred oakum. This is then covered with cement forming a projecting ledge, which keeps wet out of the joint.

Courses of the brick or stonework are sometimes allowed to project over the joints in a similar way, or slates, tiles, or flat stones may be built in for the same purpose.

Cisterns.—The various forms of cisterns, and the lead pipes and apparatus connected with them, do not come within the limits of this course, and cannot here be entered upon.

The lead used for lining cisterns must have soldered joints; but the water keeps it from expansion and contraction.

CHAPTER XI.

CAST-IRON GIRDERS, BRESSUMMERS, AND CANTILEVERS.

THE consideration of the strains upon iron beams, and of the dimensions required to resist them, will be entered upon in Part III., but it is necessary to note in this section one or two points that fall within the Elementary Course.

This course merely requires "a knowledge of the best cross section for cast-iron beams in use for floor girders, or as bressummers,¹ or as cantilevers,² and to be able to draw such a section from given dimensions of flanges."

Without going into particulars reserved for Part III., it will be sufficient to mention that experiment has proved the best section for a cast-iron beam to be of a T shape, one of the flanges having an area of about six³ times that of the other.

When such a beam is supported at both ends,⁴ as in a girder or bressummer, the larger flange is placed downwards, as in Fig. 275. When the beam is used as a cantilever, that is, fixed only at one end, so as to project from the wall, the large flange is placed uppermost, as in Fig. 276.

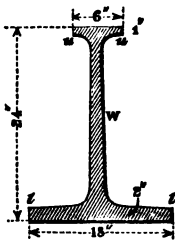

Fig. 275.

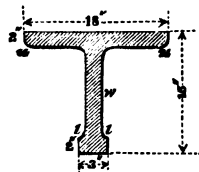

Fig. 276.

With regard to the method
of drawing a section in its

¹ A bressummer is a girder over a wide opening, and generally supporting a wall above it.

² A cantilever is a bearer, of which one end is fixed in the wall, the other end being unsupported.

³ The reason for this is that cast-iron on the point of fracture offers much greater resistance to compression than to tension. The flange that is in tension is, therefore, made larger than the other. In a girder supported at both ends the lower flange is in tension, and must, therefore, be larger. In a cantilever the upper flange is in tension, and the small flange is downwards. Authorities differ as to the proportions of the flanges. Some make the larger flange four or six times, and others make it only three times the area of the other flange.

⁴ Cast-iron girders should never be *fixed* at the ends.

right proportions, nothing can be more simple. The depth of the girder (generally about $\frac{1}{12}$ to $\frac{1}{10}$ the span) being known, and the size of the lower flange having been calculated, the upper flange is drawn so as to have $\frac{1}{4}$ to $\frac{1}{6}$ the area of the bottom flange. This is for a girder or bressummer; for a cantilever the flanges are reversed.

For example, in the girder whose section is shown in Fig. 275, the depth given is 24 inches, the area of the lower flange 18 inches by 2 inches = 36 inches, the area of the upper flange should therefore be $\frac{1}{6}$ of 36 inches = 6 inches. The web is gradually tapered, its thickness at the bottom being equal to that of the lower flange, and at the top equal to that of the upper flange, so that there are no sudden changes in the thickness of the metal, which would lead to unequal contraction while cooling, and consequent rupture at the junctions of the unequal parts. For the same reason both the flanges and the web are often made of the same thickness throughout. The method of calculating the strength of girders, their shape in longitudinal section and plan, and other points connected with their construction, will be described in Part III.

CHAPTER XII.

J O I N E R Y .

General Remarks.—The joiner's work is distinguished from that of the carpenter, as being necessary, not for the stability of the building, but for its comfort as a habitation.

It includes making and fixing the doors, frames, sashes, and shutters, also wooden stairs, linings of all kinds, architraves, skirtings,¹ and floor boards.

These are all prepared in the workshop. A great deal at the present time is done by machinery, and the work of the joiner is daily becoming more confined to fixing only.

As the joiner's work is generally seen from a short distance, it must be fitted with care and exactness, and requires greater neatness and smoothness of finish than carpenters' work.

The thorough seasoning of the wood for joiners' work is of the first importance. Some particulars connected with the selection of timber for this purpose are given in the chapter on Materials, Part III.

All framing should be fitted and put together, and left as long as possible, before it is glued or wedged up, which should be done, if practicable, in summer when the wood is most dry.

Large pieces of timber should never be used in joinery.

The interior of all joints for outside work should be painted over with white lead ground in linseed oil; those for inside work glued.

Joiners' work is generally put together with the aid of a cramp; great care should, however, be taken in cramping and wedging up to prevent a strain upon the timbers, which would lead eventually to cracking and distortion.

Beadings.—These are adopted generally for ornament, or in order that the opening of a joint caused by shrinkage may be hidden in the shadow cast by the projection of the bead.

¹ The consideration of linings, skirtings, architraves, and the grounds to which they are fixed, does not come within the limits of this course. Some of these are, however, shown in a few of the figures to make them more complete, and to save repeated illustrations when they are described in Part II.

Beads are narrow, convex, plain mouldings;¹ in section generally parts of a circle.

When the bead is formed upon a board, in the substance of the wood itself, its upper surface being flush, or nearly so, with that of the board, it is said to be "*struck*" (see Figs. 278, 279, 280).

If the bead is formed in a separate strip, and nailed or bradded² to the board, it is described as "*laid in*" or "*planted*" (see Fig. 281).



Fig. 277.

A *Nosing or Rounded Edge* is formed by rounding the edge of a piece of stuff, as shown in Fig. 277. It is frequently used for finishing off the edge of a projecting board, such as the tread of a step, a window board, etc.



Fig. 278.



Fig. 279.



Fig. 280.



Fig. 281.

Quirked Bead.—In Fig. 278 the circular portion is the section of the bead, and the indentation at the side is called a "*quirk*."

A *Double-quirked Bead* is one with a quirk on each side, as in Fig. 279. It is also known as a *Flush Bead*, because it is flush with the surface of the wood.

A *Staff or Angle Bead* is a double-quirked bead, formed upon an angle, as shown in Fig. 280. It is sometimes called a *Return Bead*.

A *Cocked Bead* is one which projects above the surface of the board. In order to avoid reducing the whole surface of the board, the bead may be made in a separate strip, and planted upon it, or laid in a shallow groove, as in Fig. 281.

A *Cocked Bead and Fillet* is one resting upon a flat strip or fillet slightly wider than itself, and planted on to the surface of the board, as in Fig. 308.

Reeding consists of parallel beads placed close together (see p. 179).

The *Torus* is a very large bead, surmounted by a flat strip or

¹ *Mouldings*, technically so called, do not fall within the limits of the Elementary Course, but are described in Part II.

² A *brad* is a particular form of nail, and is described in Part III.

"fillet," as shown on a small scale on the upper edge of the skirting, *Sk*, in Fig. 317.

The torus is generally considered as a moulding, and is placed under that head in Part II.

The distinction between a torus and a bead is that the former is always surmounted by a fillet.

The above-mentioned are the most simple beads in common use. There are several combinations of these, which cannot be further considered in this course.

The different positions in which beads are used are referred to farther on.

Shooting is simply making the edge of a board straight and smooth by planing off a shaving. A board is said to have its "edges shot" when both edges have been made smooth and true with a plane.

Scribing is cutting the edge of a board to fit an irregular surface; thus the skirting in Fig. 318, if not tongued into the floor (as shown), would be scribed at the bottom to fit the boards supposing they were uneven.

Rebating has already been described at page 92.

Chamfering is taking off the "arris" or sharp edge, so as to form a flat narrow surface down an angle. This is frequently done for ornament, and also to render the angle less liable to injury.

Chamfers are also often used for the same purpose as beads, especially on the edges of boards forming a close joint, so as not only to form an ornament, but also to hide the opening caused by shrinkage. An example of chamfers thus applied is shown in the plan of the door, Fig. 294.

V-JOINT is the angle formed by the meeting of chamfers on two adjacent edges, as in the boarding of the door above referred to.

STOP CHAMFER is one in which the chamfer is not carried to the extremity of the arris, but stopped and sloped, or curved up at the end till it dies away again into the square angle. Examples of this are seen in the framing of the door, Fig. 293, where the chamfers are stopped about an inch short of the extremities of the rails and braces.

Housing consists in letting the whole end of one piece of timber for a short distance into another. Thus the top-lining, *tl*, in Fig. 322, is housed into the inside and outside linings.

JOINTS.

When large surfaces have to be covered with boarding, the pieces should be as narrow as possible, in order that the shrinkage in each, and the consequent opening of the joints, may be reduced to a minimum.

Such shrinkage, however, there will inevitably be, and several arrangements are adopted for preventing cold air, dust, etc., from penetrating through the opening thus made between the boards, also in order to prevent the shrinkage from injuring the appearance of the joints; and further, to counteract the tendency of an ill-seasoned board to warp,¹ twist, and raise its edges above the general plane of the surface.

Several joints of this nature have already been described in the section on Floors (see page 94).

Plain or Butt Joints are explained and figured at page 93. The opening caused by the shrinkage of such a joint is, of course, very apparent; and there is nothing to prevent a board from twisting its edges above the surface.

Dowelled Joint is shown in Fig. 211. The shrinkage in this joint is visible, and causes an opening, but the dowels keep the surfaces of the boards in a true plane.

Grooved and Tongued Joint is explained and figured at page 94.

Match Boarding consists of boards put together with the last-mentioned joint. It is so called because the groove is formed with one plane and the tongue with another to match or correspond, so as to fit the groove.

Plough Grooving is so called because the groove is formed with a peculiar plane called a "plough."

Cross Grooving is the same as the above, but that the groove is cut across the grain of the wood.

Slip Feathers are detached tongues or strips of iron or of hard wood cut across the grain for strength; in using them both boards have to be grooved and the tongue inserted, as shown in Fig. 209. Tongues are generally of hoop iron, and slip feathers of wood cut across the grain.

If a slip feather is cut with the grain—that is, if the grain runs parallel to the length of the slip—and it is glued tight into the grooves, it is very liable to split longitudinally when

¹ Sc. for warped is *Thrawn*.

the boards it unites commence to shrink. This cannot happen with a *cross tongue*—that is one cut across the grain.

Ploughed and Tongued—**GROOVED AND FEATHERED**—are terms applied to boarding prepared with tongues or slip feathers.



Fig. 282.

Dovetailed Slip Feathers are of a double dovetail shape in section (see Fig. 282), and must of course be pushed into position endways from the extremity of

the boards. They are very seldom used.

Rebated Joints.—**REBATE WITH CROSS GROOVE AND TONGUE, REBATED AND FILLETED JOINTS, and FILLISTERED JOINTS,** are all described at page 94, in connection with floor boards, for which they are most adapted.

In all the above (except the dowelled and butt joints) it will be seen that any opening caused by shrinkage of the boards will be covered by the tongue, feather, or fillet, or (in the case of the rebated, and of the fillistered joint) by the projection below of the adjacent board.

In each of the joints illustrated in Figs. 206, 207, 210, part of the width of the board itself is taken up in forming the joint, so that a greater quantity of boarding is required to cover a given surface than if joints with detached tongues, fillets, or dowels, are used, as in Figs. 208, 209, 211.

There are several elaborate forms of joint, consisting of double grooves and tongues of different lengths, combinations of the above, but they are too complicated for use in practice.

Beaded Joints.—It has been said above that a certain amount of shrinking in the boards of ordinary work is inevitable.

The actual passage of air and dust through the openings thus formed may be prevented by the various forms of tongued, feathered, and similar joints, already described; but in many positions, such as in linings of walls, in doors, etc., the unsightly appearance presented by the gaping joints between the boards would be objectionable.

In such cases, to hide the openings caused by shrinkage, a quirked bead is "stuck" upon one angle of each board, in order that the opening of the joint may be hidden in its shadow, or look merely like another quirk on the opposite side.



Fig. 283.

Fig. 283 shows the bead as applied to a grooved and tongued

joint; it may be used in the same way for rebated or plain butt joints.

Dovetail Joints are chiefly used to connect boards meeting at an angle.

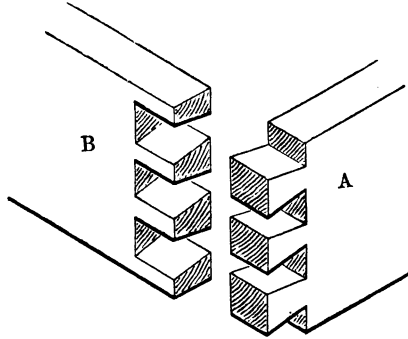

Fig. 284.

Common Dovetail Joint.—In this the edge of each board is cut into a series of alternate projections and indentations, known as the “pins” and “sockets,” which fit one another and form the joint. In Fig. 284 the pins are formed upon A and the sockets on B.

The ends of the projections or dovetails show on each side of the angle formed by the boards when they are put together.

In some cases the spaces between the pins are only equal in size to the pins themselves, as shown in Fig. 284. This makes the strongest joint, but very frequently the pins are placed much farther apart.

The angle or bevel of the sides of the dovetail should vary according to the nature of the wood in which it is formed. A dovetail in hard wood should have more splay or bevel than one in soft wood.

The common dovetail is chiefly used for the angles of drawers and superior boxes, but it is also occasionally adopted in building for securing the angles of skirtings, and for casings of a superior description.

MITRED, or SECRET, DOVETAILS and LAP DOVETAILS are modifications of the above, used chiefly by cabinetmakers; they will be described in Part II.

Mortise and Tenon Joints, used for framing in joiners' work, resemble those in carpentry, but are much smaller, and require to be made with greater care and exactness, so that they may fit smoothly in all their parts.

The thickness of the tenon varies from $\frac{1}{3}$ to $\frac{1}{4}$ of that of the framing, care being taken to leave sufficient substance in the

cheeks of the mortise. The width of the tenon should not be more than 5 times its thickness, or it will be liable to bend.

HAUNCHING a tenon is the cutting away a part of it, so as to leave a piece, h (projecting to a distance of only $\frac{1}{2}$ inch or 1 inch), between it and the outer edge of the rail on which it is formed. This haunch gives the tenon great lateral strength, and saves cutting so large a mortise hole. The haunch and the mortise to receive it may extend to the outer edge of the pieces framed together.

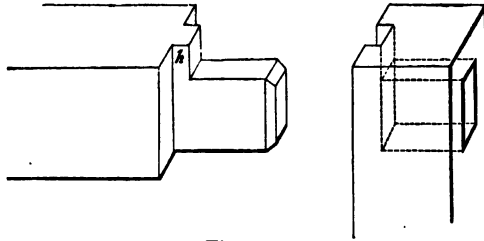

Fig. 285.

Examples of haunching are shown in the rails of the door, Fig. 304.

DOUBLE TENONS are formed on very wide rails in framing. They prevent the rail from twisting, do not shrink so much as a single wide tenon, and do not require so large a mortise, which latter tends to weaken the framing in which it is formed. As the wood between the roots of the tenons shrinks more *across* the grain than the wood between the mortises does *with* the grain, the result often is to split the rail. The space between the tenons is haunched, as will be seen in Fig. 286 by examining the mortise.

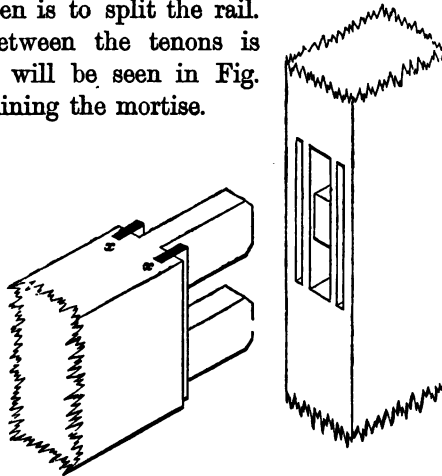

Fig. 286.

An example of such haunching is also shown in the lock rail of the door, Fig. 304.

Occasionally two tenons side by side in the thickness of the framing are advisable, as, for example, in the lock rail of a thick door, to receive a mortise lock (see M, Fig. 304); but where a single tenon with cross tongues can be used, it is stronger and more easily fitted.

STUMP TENONS are required if the frame be very thick as well as wide. They are tongues or projections left in the wood on each side of the tenon.

Slip feathers or cross tongues inserted in ploughed grooves are frequently used for the same purpose, as shown at *xx* in Fig. 286.

FRAMING.

Frames in joinery consist of narrow pieces of wood connected by mortise and tenon joints, and grooved on the inside to receive boards, which fill up the openings in the framing.¹

In every frame the vertical pieces are called "*styles*," SS (Fig. 287), the horizontal pieces *rails*, RR. These constitute the framing itself, and in the example shown are filled in with panels, PP.

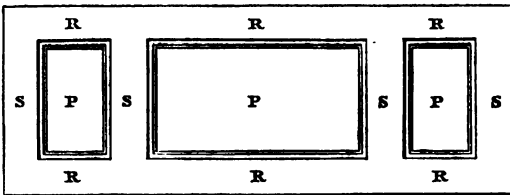

Fig. 287.

The pieces of wood forming a frame should be narrow, so as to be affected as little as possible by shrinking under atmospheric influence.

The inner edges of the styles and rails are grooved to the depth of about $\frac{1}{2}$ inch to receive the panels, which should fit so tightly as not to rattle, and yet should be free to contract.

Panelling.—The boarding which fills in each opening of any piece of framing is called a *panel*.

Boards, except of American pine, can seldom be obtained of sufficient width to form panels in one piece, on account of shakes and other defects.

¹ Sc. for Framed is *Bound*.

A joint down the panel is therefore generally necessary; this should, if the stuff is thick enough, be ploughed, and a slip feather be glued into it, which keeps the surface of the panel in a true plane and holds the joint together, so that when the panel shrinks it comes slightly away from the grooves in the styles, as it is intended to do.

The pieces thus used to form panels should be reversed alternately, so that the grain may run in opposite directions.

A piece of strong canvas glued over the back of a panel will assist in keeping it together.

There are several forms of panels, known by technical names, depending upon the manner in which they are respectively constructed and ornamented.

The different kinds of panels now to be described are illustrated in Figs. 295 to 303. These figures are elevations and sections of doors, but the same constructions are used for panelling of all descriptions.

SQUARE AND FLAT PANELS¹ are those in which the boards are of the same thickness throughout, thinner than the frame, sunk square below its surface, and not ornamented by beads or mouldings. The panels marked A and B in Figs. 295 and 297 are "square and flat"¹ or "square" on both sides.

MOULDED AND FLAT.¹—When the edge of the panel, close to the framing, is ornamented by a moulding either "planted" or "stuck" on to the inner edge of the frame, it is designated as "moulded," or "moulded and flat."¹ Panel F, Fig. 301, is moulded on both sides, and panel E moulded in front only.

FLUSH PANELS have their surface "flush," or in the same plane with the surface of the frame. A panel may be flush on one or both sides.

In nearly all forms of flush panelling the edges of either the frame or panel are ornamented by a bead, chamfer, groove, or moulding, to cast a shadow and conceal the shrinkage.

If required to be flush on both sides, the back is generally filled in with a separate solid piece, or with diagonal battens crossing their grain with that of the front panel.

D, Fig. 298, is a panel flush on both sides, while C is flush in front only.

¹ The words "and flat" (originally used to prevent the panel from being roughly bevelled off toward the edges to fit the groove) are now generally omitted, and a panel is described as "framed square" or "moulded," it being understood that the surface is flat and the panel of equal thickness throughout.

SOLID PANELS are those in which the panel is in one piece, of the same thickness as the frame, and flush on both sides with its surface, like panel D, Fig. 298.

BEAD-FLUSH panels have a bead all round close to the inner edge of the framing, as shown in the panels I K, Fig. 299.

The bead in this case is sometimes "stuck" on the styles and rails, as shown in Figs. 305, 306.

If the framing is thin and the quirk of the bead deep, it cuts nearly through to the groove and is a source of weakness, so much so, that the swelling of the panel sometimes presses the bead off; moreover, when the framing shrinks, the mitred angle of the bead (at the corners of the panel) opens, and sticking the bead on the framing itself, entails extra trouble in putting it together.

In modern practice, however, the vertical beads are generally "stuck" (with the grain) on the panels, and as the horizontal beads cannot easily be formed across the grain, sunk rebates are cut for them on the panels close to the edges of the rails, and beads on separate strips bradded into the groove thus formed. Sometimes these strips become curved when the panel shrinks, and are apt to fall out; and as they shrink less in length (along the grain) than the panel does in width (across the grain) they cause it to split; however, as this plan is more economical than the other, it is commonly adopted.

The detached part just described is illustrated in Fig. 303, which is an enlarged vertical section of the lower part of the lock rail and upper part of the bottom panels of Fig. 299. The horizontal section of a bead-flush panel formed in this way is similar to that of bead-butt shown in Fig. 298.

BEAD-BUTT panel is a modification of the last, used chiefly in inferior work.

In this case the beads are formed only down the sides of the panel, *with* the grain of the wood, and always "stuck" on the panel itself, as shown in elevation in Fig. 295, and in plan in Fig. 298, the panels being marked C D in both figures.

REED-FLUSH panel is one covered with parallel semi-cylindrical beads, close together, either "stuck" in the substance of the panel, if they run with the grain, or "planted" on if they run across the grain.

GROOVED PANEL.—In this a groove is formed around the outside edge of the panel, close to the framing, causing a dark shadow, which answers the same purpose as a bead.

CHAMFERED (or V-JOINTED) PANEL is ornamented by chamfers run down the edges of the framing and of the panel, as shown in the back of the panel marked D in Fig. 298.

RAISED PANEL¹ has the surface nearly flush with the frame in the centre, but recessed back at the sides where it meets the frame.

The rising of the panel may either be left square, as at H, or enriched by a moulding, as in panel G, Fig. 302. See also Fig. 310.

The frame also is frequently ornamented with mouldings, either "stuck," as in Fig. 310, or planted on, as in Figs. 302, 308.

Panelling is often enriched with mouldings of different descriptions; these are either "stuck" on the frame, or more frequently laid or "planted" in in strips bradded on to its inner side.

Sometimes, especially in doors, the panelling is intended to have a better appearance on one side than the other. It is then formed differently on the two sides, and named accordingly.

For example, in Fig. 301, the panel E is "moulded in front with square back."

The panel F is "moulded on both sides."

In Fig. 298, panel D has a "bead-flush front, with chamfered and flush back."

Panel G, Fig. 302, is a "moulded and raised panel with moulded rising on both sides;" while H is a "raised panel with square rising in front, and square back."

DOORS.

Internal doors should be at least 2 feet 9 inches wide, and 6 feet 6 inches high. A usual opening is 3 feet, or 3 feet 6 inches. Very large rooms sometimes have doors 8 feet or more in width, and 8 feet to 10 feet high.

Entrance doors vary in width from 3 feet 6 inches to 5 feet.

When a door is more than 3 feet 6 inches wide it should be hung in two halves ("*hung folding*"), by which arrangement it requires less space into which to open, and the leaves are lighter.

Doors should, as a rule, open inwards, *from* a person entering the room. The hinges should generally be on his right, but this is sometimes altered by peculiarities of the position.

¹ Sc. *Fielded panel*.

The following letters are used to mark the parts mentioned, in the figures of this section relating to doors :—

Architrave A	Ledges ledge
Brace br	Lock L
Frame F	Rails R
Ground g	Styles S
Hinge h	Wood Brick WB
Latch l	„ Plug wp

Doors receive their distinctive names according to the nature of their construction.

A **Ledged Door**¹ is the simplest kind of door made, and is used only for temporary or inferior buildings.

The very commonest consist of vertical boards butted against one another, and connected by two or three horizontal pieces called “*ledges*”² nailed across the back.

In ledged doors of a better class the boards are grooved or ploughed and tongued together, sometimes united by rebated joints, and nearly always beaded or chamfered.³

The ledges should be fixed on the inside of the door, which is in Figs. 288 289, shown to open outwards. The rebate in the frame is here shown of a depth only equal to the thickness of the boards or door itself, the ledges being cut off at the ends so as not to fit into the frame.

In some cases, however, the ledges are made of a length equal to the full width of the door, and recesses are cut out in the frame beyond the rebate to receive them where they occur.

The arrangement here shown would be objectionable for a door of any importance, for even when locked it can at anytime be opened by unscrewing the hinges from the outside.

If such a door be required to be very secure, it should have hinges on the inside, as in Figs. 290, 291, or be hung with hook and

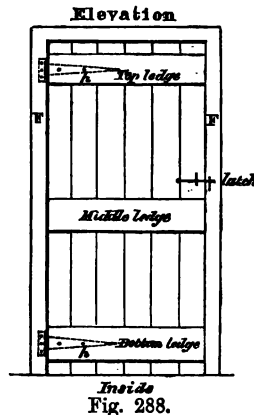

Fig. 288.

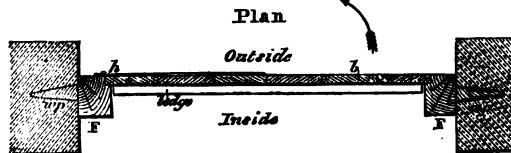

Fig. 289.

¹ Sc. Barred Door.

² Sc. Bars or Cross Bars.

³ A “*Proper-Ledged Door*” is one in which the boarding is wrought, ploughed, tongued, and beaded.

eye hinges fixed with bolts and nuts (see Figs. 292, 294), which cannot be removed when the door is locked.

A **Ledged and Braced Door** has braces diagonally across the back in addition to the horizontal ledges, and generally housed into them, as shown in Fig. 290.

The ledges and braces shown in this figure are bevelled or beaded, and the boarding is ploughed, tongued, and beaded on both sides.

The braces should be fixed so as to incline downwards toward the side on which the door is hung.

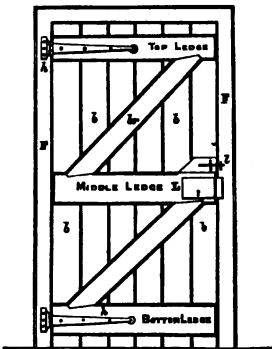

Fig. 290.

The beads on the inside of the door are often omitted, but are just as much required there as on the outside, to conceal the joints when the boards shrink.

The frame generally has a bead run round its inner edge to conceal the joints between it and the door.

The door illustrated in Figs. 290, 291, is arranged to open inwards, the rebate in the frame being made of a depth equal to the united thicknesses of the boarding and ledges as shown in Fig. 291.

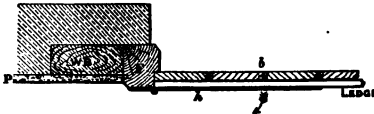

Fig. 291.

Sometimes the frame is rebated to a depth only sufficient to receive the boarding alone, in which case the hinges are fixed upon blocks attached to the frame, the surfaces of the blocks being flush with those of the ledges.

A Framed and Braced Door.¹—This door consists of a frame strengthened by a middle or lock rail and diagonal braces, the edges of which are stop-chamfered to give them a light appearance, as shown in the internal elevation Fig. 293.

The ends of the braces are tenoned into the styles and rails as shown; the upper ends are frequently made to abut partially upon the styles, but this has a tendency to force them off the rails. The braces should therefore be connected at the upper end with the rails only, as shown in Fig. 293. The lower ends may abut

¹ Sometimes called Framed, Ledged, and Braced.

partially upon the hanging style, and they are sometimes kept entirely clear of the rails.

Elevations.

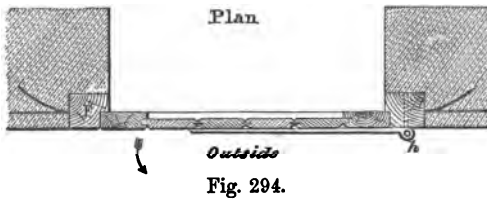
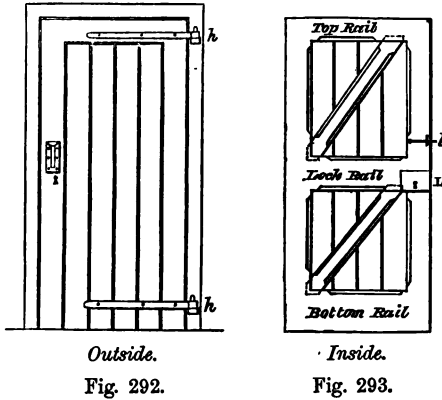

The braces and lock rail are thinner than the remainder of the framing by the substance of the boarding, which lies against them and is nailed to them.

In external doors the bottom rail is generally covered by the boarding, so as to be invisible from the outside. This enables the rain to get clear away, instead of being caught by the bottom rail.

In Fig. 293 the framing is stop-chamfered, and the boarding ploughed, tongued, and V-jointed on both sides. The door opens outwards, and is hung with hook and eye hinges.

A Framed and Ledged Door is like that shown in Fig. 293, without the braces.

Panelled Doors consist of a framework of narrow pieces of equal thickness put together with mortise and tenon joints, and grooved on the inside edges to receive the panels.

Fig. 295 shows the elevation of a four-panelled door, and Fig. 299 that of a door with six panels.

Figs. 297, 298, 301, 302, are horizontal sections taken through the panels identified in elevation by the same letters.

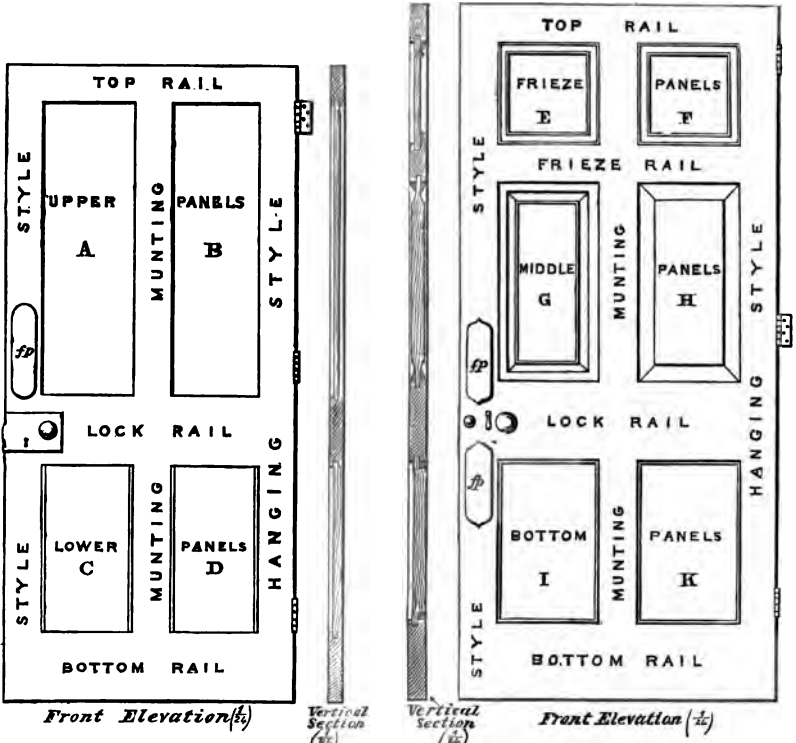

Fig. 295.

Fig. 296.

Fig. 300.

Fig. 299.



Fig. 297.



Fig. 298.

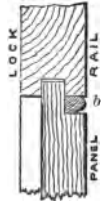

Fig. 303.



Fig. 301.



Fig. 302.

The horizontal bars of the framing are called "*Rails*," and the vertical bars "*Styles*." The centre style is also called a "*Munting*."¹

In a six-panelled door the uppermost horizontal bar is the *Top Rail*, the next below is the *Frieze Rail*, the next the *Lock* (or *Middle*) *Rail*,² and the lowest the *Bottom Rail*.³

The two highest panels are the *Frieze Panels*, the two next the *Middle Panels*, and the lowest the *Bottom* or *Lower Panels*.

The *Top Rail* and *Frieze Rail* are generally of the same width as the *Styles* and *Munting* (about $4\frac{1}{2}$ inches); the *Lock* and *Bottom Rails* are about twice, or frequently rather more than twice, as wide as the others.

The lower edge of the lock rail should be about 2 feet 6 inches or 2 feet 8 inches above the ground, so that the lock may be at a convenient height for the hand.

In a four-panelled door there are no *Frieze Panels*. The uppermost panels are the *Upper* or *Top Panels*. The *Frieze Rail* is also omitted, the other parts being named in the same way as in the six-panelled door.

The number, relative size, form, and position of the panels is varied in different doors according to taste and to the purpose for which they are intended.

In six-panelled doors the frieze panels are often of oblong form, being wider than their height, and the four lower panels nearly equal in size to one another (see Fig. 304). Sometimes the small panels are placed in the middle of the door.

METHOD OF PUTTING A DOOR TOGETHER.—Fig. 304 shows the method of putting together a

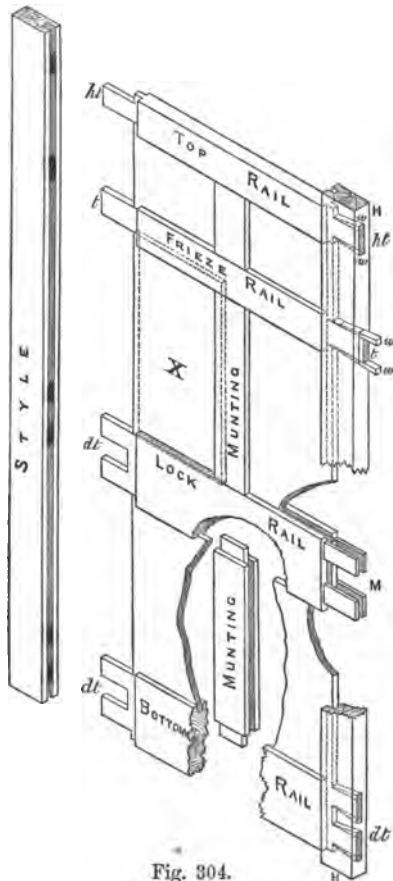

Fig. 304.

¹ Sc. *Mounter*.

² Sc. *Belt Rail*.

³ Sc. *Sole Rail*.

"*six-panelled square framed door.*" A comparison of this figure with the horizontal section of a square framed panelled door given in Fig. 297 will clearly show its construction. The mouldings are omitted in Fig. 304.

The figure shows one style of the door detached, the other is in position, and supposed to be transparent, in order to show the construction of the tenons which fit into it.

The rails and styles are continuous throughout their length; but the munting is divided into three parts tenoned in between the rails. A portion of the door is broken away to show the construction of the munting between the bottom panels.

It will be noticed that the styles are longer than the height of the door, having projecting "*horns,*" HH, which extend above and below the bottom rails. These horns are left until the door is wedged up, in order that there may be sufficient substance to resist the pressure of the wedges, which would otherwise, pressing in the direction of the grain, force out the wood beyond the mortise in the style, and destroy the joint.

These horns are, of course, removed when the door is finished and cleaned off ready for fixing.

The ends of the rails are formed with tenons of different kinds, as shown in Fig. 304. These fit into mortises in the styles, and are then secured by wedges.

The top rail has a single haunched tenon at each end, the frieze rail a common tenon at each end, and the bottom rail a double tenon at each end.

The lock rail is provided at *dt* with a double tenon, strengthened by a haunch between them; thus the necessity of a very large mortise (which would cut the style nearly in two) is avoided. When a mortise lock is used for a thick door, that end of the rail in which the lock is to be fixed should be provided with four tenons as shown at M; between these there is room for the lock, which can be inserted without interfering with the tenons. The construction of this joint is shown in the figure, a portion of the style having been broken away in order to show the tenons more clearly.

The common practice, however, is to make an ordinary double tenon in the centre of the framing (like that at *dt*), the result being that the formation of the mortise for the lock cuts away portions of the tenons, and weakens the joint.

The inside edges of the styles, munting, and rails, are grooved

down the centre about $\frac{1}{2}$ inch deep and for $\frac{1}{3}$ of their width to receive the panels. The edge of the panel X is shown in dotted lines.

The door having been made, the tenons carefully fitted to the mortises, etc., is put together without any fastening, and left until immediately before it is required to be fixed, in order that it may have as long a time as possible to season.

Before being fixed the door is taken to pieces, the mortises cleared out, the tenons covered with glue, the styles, munting, and rails tenoned into each other, and the panels inserted. The deal wedges, *ww*, are then dipped in glue and driven in as shown on each side of the tenons, the flat part of the wedge being next to the tenon.

In the figure the wedges securing the frieze rail are shown as originally fixed. Those for the top and bottom rails have been cut off flush with the style; this is shown so for the sake of illustration, but in practice it is not done until all the parts of the door are put together and "*wedged up*."

The door should then be laid upon a flat firm surface till the glue is dry.

The different descriptions of Panelled Doors are distinguished by technical names expressing their thickness, the number of panels they contain, and the kind of panelling.

The doors in Figures 295 to 303 are each shown with two or three different kinds of panels, but it will be understood that this is only to save repeated illustrations. As a rule,¹ all the panels on the same side of a door are of the same construction, though frequently those on the front are more ornamented than those on the back of the door.

By combining the information contained in the figures, the student will be able to draw several varieties of doors. The names of some of these, and a reference to the figures from which they may be constructed, is now given, and is arranged for convenience in a tabular form.

¹ There are, however, exceptions to this rule, as, for example, in Fig. 306, where the upper panels are moulded both sides, but the lower panels have a bead-flush front for strength.

Description of Door.	Arrangement and Size of Panels.	Section of Panels.	Appearance of Panels in Elevation of Front, Size and Arrangement being as described in Col. 1.
1½-inch Four-panelled— Square framed . . .	As in Fig. 295	Like AB, Fig. 297	Like AB, Fig. 295
Bead butt and square . . .	" " 295	" C, " 298	" CD, " 295
Filled in solid, bead butt, and back chamfered flush . . .	" " 295	" D, " 298	" CD, " 295
2-inch Six-panelled— Moulded and square . . .	" " 299 or " 304	" E, " 301	" EF, " 299 " EF, " 299
Moulded on both sides . . .	" " 299	" F, " 301	" IK, " 299
Bead flush and square . . .	" " 299	" I, " 303	
Raised and moulded panel with moulded rising both sides . . .	" " 299	" G, " 302	" G, " 299
Raised panel and square rising, back square . . .	" " 299	" H, " 302	" H, " 299
2-inch Six-panelled door hung folding, four upper panels moulded on both sides, bottom panels bead flush and moulded back . . .	" " 307	Figs. 305, 306	Two lowest panels like IK, Fig. 299; the other panels like those in Fig. 307.

A TWO-LEAVED or FOLDING DOOR is hung in two flaps, one on each side of the opening.

Figs. 305, 306, 307, show respectively the plan, a vertical section through the panels, and the interior elevation, of a six-panelled outer door—hung folding—with a fanlight over it.

The piece framed in between the door-posts, separating the fanlight from the door, is called a *Transom*. Its upper surface is weathered outwards, and the joint between it and the fan-light is sometimes secured by a water bar or stepped so as to prevent the entrance of wet.

The four upper panels of the door are moulded on both sides, while the two lower panels are made bead-flush on the outside, so that they may be thicker and stronger.

In the example given the wood linings are secured to plugs let into a rough axed arch, shown in section, Fig. 306, and partly in elevation (Fig. 307), some of the plaster, etc., having been removed so as to expose it. A concrete lintel or wood lintel with relieving arch may be used instead of the rough axed arch to support the wall above the door.

In this illustration the joints and soffits of the opening are



Fig. 308.

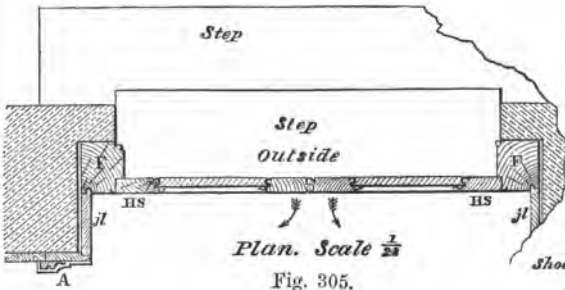
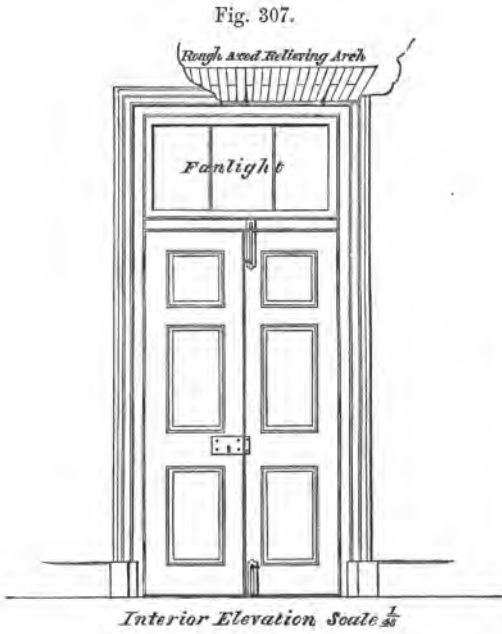
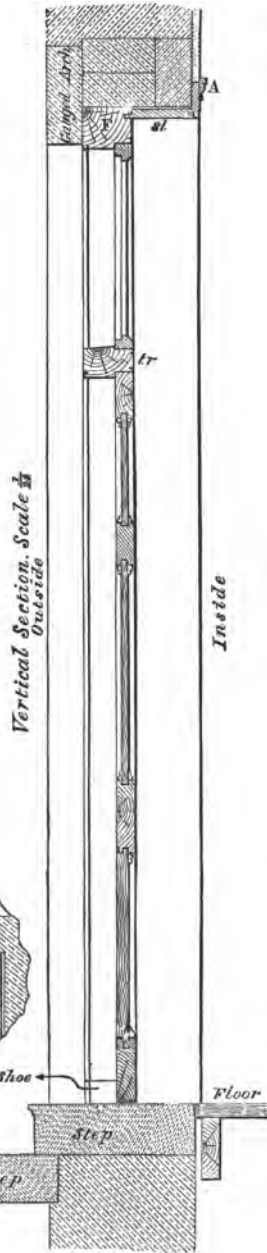

Fig. 306.



covered by wood linings, the description of which does not fall within the Elementary Course. When there are no linings the frame is grooved to receive the plastering of the wall, as in Figs. 291, 311.

The joint formed by the meeting of the leaves may either be simply rebated and beaded, as shown in Fig. 305, or it may be further secured by a detached "cocked bead and fillet" planted on each side, as in Fig. 308.

DOUBLE-MARGINED DOORS are hung in one flap, but have a bead run down the centre, so that they may look like doors hung "folding."

SASH DOORS have their upper portion glazed. The styles of the glazed portion are often made narrower than those of the panels below, and are then described as "*diminished styles*." In this case the joints between the ends of the lock rail and the styles are cut obliquely instead of being vertical. When the door is glazed with heavy plate glass, which takes the place of panels, the styles need not be diminished.

JIB DOORS are made in appearance exactly like a portion of the wall of the room, the chair rail, dado, etc. (if any) being carried across the door. They are made use of for the sake of uniformity of appearance in a room, to save the expense of having a second door to match one necessarily fixed for use.

SLIDING DOORS have metal wheels fixed upon either their top or bottom edges: these wheels run upon iron rails fixed above or below the door, which moves laterally.

Door Frames.—There are several ways of hanging doors, but this course extends only to the consideration of those hung in solid door frames.

SOLID DOOR FRAMES consist of two posts, whose upper extremities are tenoned into a "*head*" or "*lintel*," and whose feet are furnished with cast-iron shoes¹ (see Figs. 306, 309), each having a projecting stud in the bottom which fits into a *sill* of hard wood or stone. It is better that the frame should in external doors rest upon a stone step, as in Fig. 306, for wood sills soon decay.

The frame is either built in as the masonry progresses, or recesses are left, into which it is afterwards fitted. In the former case the ends of the head are allowed to project beyond the width of the door and posts, forming "*horns*," HH, Fig. 309, which serve to keep the frame steady in the masonry. Unless the horns are very

¹ A piece of sheet lead and a slate dowel are often substituted for the cast-iron shoe.

long, the mortises are sometimes cut through to their extremities, as shown in Fig. 309.

The posts and head for ordinary doors may be in section about 4 inches by 5 inches, and will fit conveniently into brickwork if they are made $4\frac{1}{2}$ inches square. They are, however, frequently made of much lighter scantling, in which case the recesses to receive them should be diminished accordingly, or spaces will be left behind the frame which are seldom solidly filled in.

A rebate is formed round the inside of the posts and head, into which the door fits when shut. This rebate is worked through the whole length of the head to the extremities of the horns, the tops of the posts being fitted accordingly.

The inside edge of the rebate on the frame is generally beaded or chamfered, so as to conceal the joint between the door and the frame. This bead is not shown in Fig. 309 (see Figs. 290, 305).

Any chamfer or bead on the posts should be continued upon the cast-iron shoes.

The rebate to receive the door is sometimes formed by nailing on a wooden fillet or *stop* instead of checking out the solid frame.

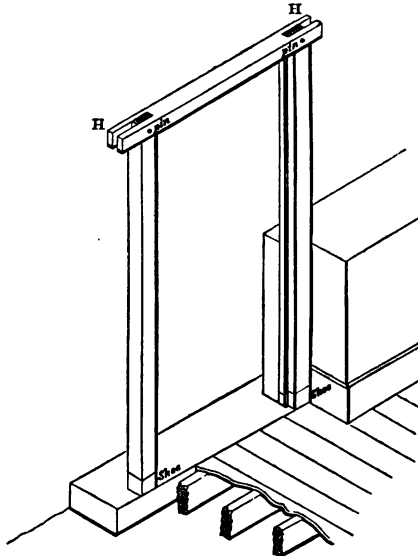

Fig. 309.

The solid frame is generally used for external doors, and its position in the wall is varied according to circumstances.

The frame itself is secured to the masonry either by being nailed

to wood plugs, as in Fig. 289, to wood bricks, as in Fig. 291, or by being fastened to forked wrought-iron holdfasts built in, as in Fig. 294.

In very common work the frame is simply attached to the inside of the jambs of the opening without any reveal, as in Fig. 289; but in order to make a firm job, sinkings or recesses to receive the frame should always be formed in the wall.

When the door is required to open outwards and fold back against the wall, the frame is inserted in recesses formed in the exterior angles of the opening, so that the front face of the frame is flush with that of the wall. An example of this is shown in Fig. 294.

External entrance doors of houses are, however, usually made to open inwards, the frame being fixed in a recess formed on the inside of the wall, as shown in Fig. 310, so that the masonry of the reveal prevents the wind and rain from penetrating between the frame and the wall.

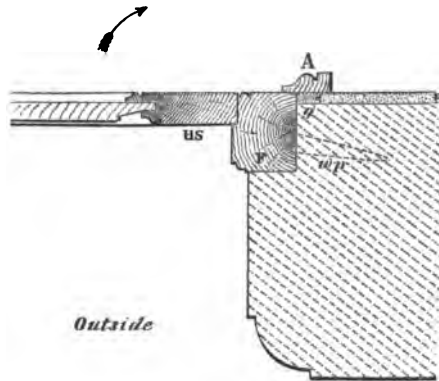

Fig. 310.

The reveal shown for the external door in Fig. 305 is only $4\frac{1}{2}$ inches thick, but unless there is a porch or other protection in front of the door it is an advantage to leave as great a thickness as possible of masonry in front of the frame, in order that the door may be protected from the weather.

WINDOWS.

The sizes of windows are regulated both by their external appearance, and also by the arrangements required for light and ventilation in the rooms.

Several rules are given by different writers for the sizes as regards appearance. These need not here be entered upon. The undermentioned may be useful to regulate the size as regards internal arrangement.¹

The area of light should = $\sqrt{\text{cubic contents of room}}$.—*Morris*.

The breadth of window = $\frac{1}{3}$ (breadth height of room).—*Chambers*.

The height generally from 2 to 2 $\frac{1}{2}$ times the breadth.

There should be 1 foot superficial of window space to every 100 or 125 cubic feet of contents of the room in dwelling-houses, or 1 foot superficial to 50 or 55 cubic feet in hospitals.—*Galton*.

The window sill should generally be about 2 feet 6 inches from the floor inside.

Windows should (as nearly as the construction will admit) reach to the ceiling, for the sake of ventilation.

Windows consist of two parts:—1. *The sash* or sashes (including the bars) which hold the glass. 2. *The frame* carrying the sashes.

The sashes may be fixed, hinged on the sides to open like a door, either in one flap or two—hinged at the top or bottom edge—suspended by lines over pulleys, with counter-weights to slide up and down—arranged to slide laterally—or hung on pivots near their centres.

The frames may be solid or hollow. The latter (which are called "*boxed or cased frames*") are required to receive the counter-weights when the sashes are hung over pulleys.

N.B.—In the figures illustrating this section the parts are marked with the distinctive letters mentioned below:—

<i>A</i> . . .	Architrave.	<i>psl</i> . . .	Parting slip.
<i>B</i> . . .	Bracket.	<i>s</i> . . .	Styles.
<i>b</i> . . .	Batten.	<i>SS</i> . . .	Stone sill.
<i>bl</i> . . .	Back lining of sash frame.	<i>SL</i> . . .	Stone lintel, or window head.
<i>br</i> . . .	Bottom rail of sash.	<i>SF</i> . . .	Solid frame.
<i>c</i> . . .	Capping.	<i>sb</i> . . .	Sash bar.
<i>f</i> . . .	Fillet.	<i>sl</i> . . .	Sash line.
<i>g</i> . . .	Ground.	<i>sk</i> . . .	Skirting.
<i>H</i> . . .	Head of sash frame.	<i>t</i> . . .	Throat.
<i>h</i> . . .	Hinges.	<i>tl</i> . . .	Top lining.
<i>ib</i> . . .	Inside bead.	<i>tr</i> . . .	Top rail of sash.
<i>il</i> . . .	Inside lining of sash frame.	<i>w</i> . . .	Weights.
<i>l</i> . . .	Laths.	<i>WB</i> . . .	Wood brick.
<i>mr</i> . . .	Meeting rails.	<i>wb</i> . . .	Water bar.
<i>ol</i> . . .	Outside lining of sash frame.	<i>wp</i> . . .	Wood plug.
<i>os</i> . . .	Oak sill.	<i>WL</i> . . .	Wood lintel.
<i>P</i> . . .	Plastering.	<i>WiBd</i> . . .	Window board.
<i>Pp</i> . . .	Pocket piece.	<i>x</i> . . .	Wedge.
<i>p</i> . . .	Pulley.	<i>y</i> . . .	Do.
<i>pb</i> . . .	Parting bead.	<i>Y</i> . . .	Rough axed arch or concrete lintel.
<i>ps</i> . . .	Pulley style.		

¹ From *Notes on Practice of Building*, printed at Chatham.

The Solid Window Frame is very simple, consisting, like that of a door, of a head, two posts, and a sill.

A rebate is run all round the frame to receive the sash, as it shuts against it, or a stop may be nailed on to fulfil the same object.

If the sash is to be fixed, the rebate should be on the outside of the frame, as in Fig. 313, for then the pressure of the wind tends to tighten the joint between them; but if the sash is to be movable, the rebate may be either outside, as in Fig. 313, or inside, according to the way the sash is hung.

It is a very common practice to fix solid frames with the rebate inside, as it is often convenient for the sash to open inwards; but it is an advantage to have the rebate outside if possible, for in that case any water which finds its way in between the sides of the frame and the sash, is stopped by the projection of the rebate, against which the sash shuts, whereas when the rebate is inside, any water penetrating at the sides is conducted downwards until it reaches the sill and trickles over it into the room.

The sill,¹ *os*, Fig. 313, is generally made of hard wood, such as oak or pitch pine, as it is much exposed; its upper surface is bevelled to fit the lower rail of the sash, "weathered" to throw off the water, and frequently throated, as in Fig. 317, to prevent the water from being blown along it; occasionally it is double throated, as in Fig. 315.

In order to prevent the wet from working in underneath the oak sill, a metal tongue or "water bar," *wb*, is inserted between it and the stone sill, as shown in Fig. 313, or a step is made in the upper surface of the latter, as in Fig. 315. This last arrangement is unusual and expensive.

Figs. 312, 313 show the external elevation and cross section of a small fixed sash in a solid frame. The plan below (Fig. 311) is on double the scale of the other figures.

Cased Frames are explained at page 198, in connection with the description of sliding sashes.

The Sash consists of rails and styles (framed together as in a door) and sash bars.² It may be either single or double hung.

¹ Sc. sometimes called *Sole*.

² Sc. for sash bar is *Astragal*. This must not be confounded with the English term *Astragal*, which is the name for a particular moulding. (See Part II.)

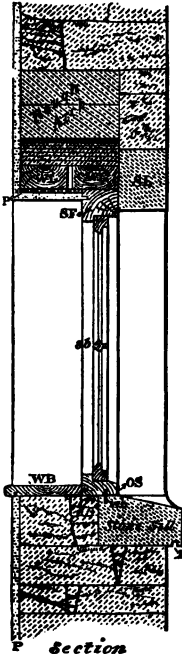

Section

Fig. 313.

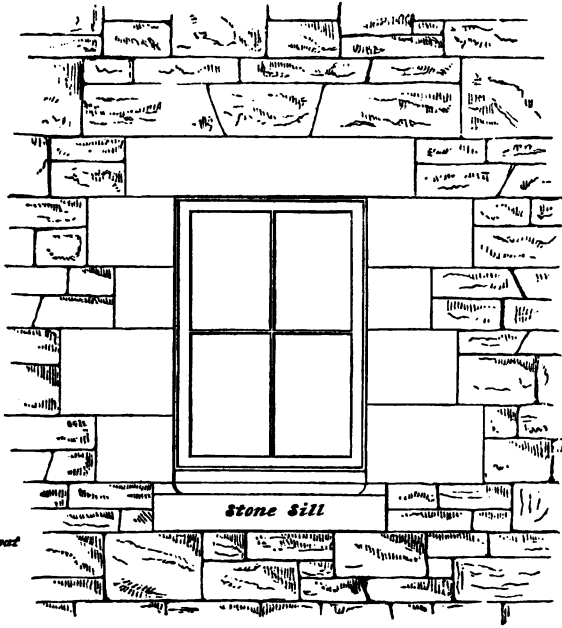

Exterior Elevation

Fig. 312.

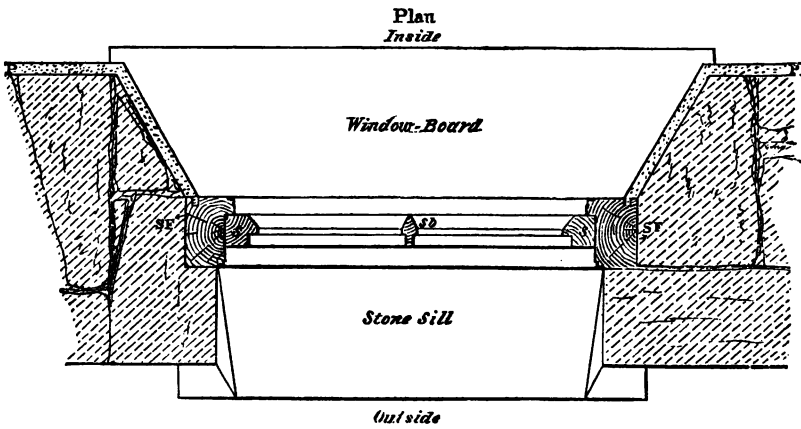

*Plan
Inside*

Window-Board

Stone Sill

Outside

Fig. 311.

In a fixed sash the vertical sash-bars are tenoned into the top and bottom rails, and run continuously between them, being mortised to receive the horizontal bars, which are cut into lengths and tenoned in between them.

When a sash is to be hung, those bars that are in the direction of the blows or jars it will receive when it is opened or closed should be made continuous, and the other bars cut and tenoned. Thus, in a sash to slide up and down, the vertical bars, and in a casement the horizontal bars, are continuous.

Fig. 314 is a plan of the junction of a vertical and a horizontal sash bar for a sliding sash. The vertical bar, VV, is not severed, but merely mortised to receive the tenons, *tt*, formed on the ends of the portions of the horizontal bars, HH. These latter are *scribed*, as shown from

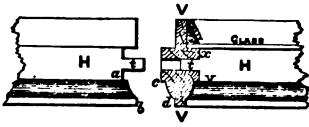

Fig. 314.

a to b, to fit the moulding, *cd*, of the vertical bar.

The tenons are sometimes made the full width of the square, *xy*, of the sash bar. In some cases the joint is *mitred* instead of being scribed—that is, an angular notch is cut upon the vertical bar from *c* to *d*, and a corresponding angle formed upon the end of the horizontal bar to fit it.

In very good work the joint is further secured by a dowel inserted between the horizontal bars to assist the tenons.

The sash bars have a double rebate (*rr*) on the outside to receive the glass, and a similar rebate is formed all round the outside of those edges of the styles and rails which are next to the glass. In Fig. 314, the glass, together with the putty which secures it, is shown on the right side of the sash bar.

When there are two sashes, as in Fig. 317, the under edge of the top or meeting rail of the lower sash is grooved instead of being rebated. A reference to Fig. 317 will show that this is necessary, in order that the meeting rails may be of the same thickness where they come in contact.

The inside of the sash bars, styles, and rails, may be left square, moulded, bevelled, or chamfered, according to taste.

An example of a bevelled or chamfered bar is given in Fig. 311, and a moulded bar is shown in Fig. 316. A square bar is rectangular in section, not ornamented in any way.

FIXED SASHES are put into solid frames, close up against the rebate, and screwed there. A bead stop is sometimes fixed on the outside to keep the joint between frame and sash more secure.

FANLIGHTS are sashes, generally fixed over a door, as shown in Figs. 306, 307. The sash is necessarily on the same side of the frame as the door, in order to be in the same plane with the latter.

SASHES HUNG ON CENTRES.—These are hung “single” in solid frames (see Fig. 315).

The sash has pivots fixed on the styles in prolongation of its horizontal axis. These pivots fall into slots in small iron sockets fixed in the frame to receive them.

If it is required that the window should fall to and close itself, the pivots are placed slightly above the centre line.

When the window is opened the lower part should move outwards, as shown in Fig. 315.

In this sash the horizontal bars (if any) extend continuously across, being mortised to receive the vertical bars. In large sashes a centre rail may be introduced,

This window is made water-tight by the following arrangement:—

A bead is fixed on the upper half of the outside, and on the lower half of the inside of the frame against which the sash abuts; the remaining portion of the bead is fixed upon the sash itself, so as to show a continuous bead when the window is shut.

Instead of fixing separate beads upon the frame, it is sometimes rebated to answer the same purpose.

Sashes hung in this manner are well adapted for windows

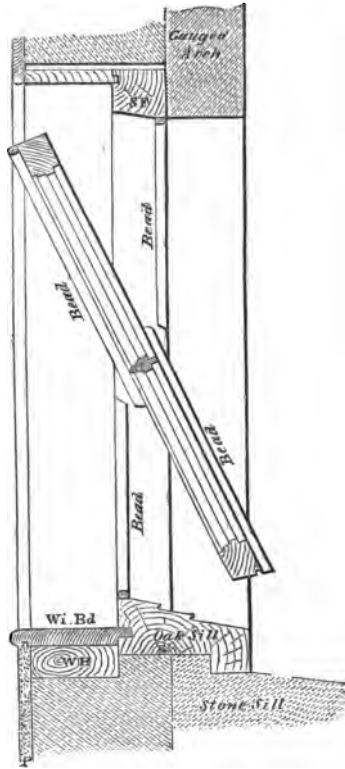

Fig. 315.

out of reach, as they can be opened and shut from below by cords.

Suspended or Sliding Sashes in "Boxed" or "Cased" Frames.—In these the styles or side-posts of the frames are hollow boxes or "cases," so made in order to receive the weights which counterbalance the sashes.

CASED FRAMES WITH DOUBLE-HUNG SASHES IN A THICK WALL.—Fig. 316 is the plan and Fig. 317 the vertical section of a window with boxed frame and sliding sashes, double hung.

Fig. 318 is an interior elevation of part of the sash and frame, with the inside lining removed, so as to show the interior of the case.

These figures are necessarily broken into portions for want of space.

The exterior elevation of this window is shown in Fig. 319, and the interior elevation in Fig. 320. Both of these figures are on a reduced scale.

Each box or case consists of the *back lining*,¹ *bl*, the *inside lining*, *il*, and the *outside lining*, *ol*, the side nearest the sash, *ps*, being called the "*pulley style*," because it carries the pulleys over which run the sash lines supporting the weights.

These portions of the casing should be grooved and tongued together, as shown in Fig. 316, but in common work the grooves and tongues are often omitted.

The upper end of the pulley style is dovetailed (or, more often, grooved) into the *head* of the sash frame, *H*, and the lower end is housed into the sill, and there secured by a horizontal wedge, *x* (see Fig. 318).

Down the centre of the pulley styles is formed a groove, into which fits a narrow strip, *pb*, called the "*parting bead*," because it separates one sash from the other.²

The parting bead is not fixed, as the outer sash cannot be put in without removing it temporarily.

The inside bead should be fixed with screws, so that it also can easily be removed if required, to put in or take out the sashes.

The inside bead *ib* is made deeper than the thickness of the

¹ *Sc. Back boxing.*

² The parting bead is sometimes carried round the upper part of the frame, being attached to the under side of the head, as in Fig. 320. This is an advantage, as it helps to keep the sash steady, and to tighten the joint.

inside lining *il*, so as to cover the joint between the inside lining and the pulley style *ps*. (See Fig. 316.)

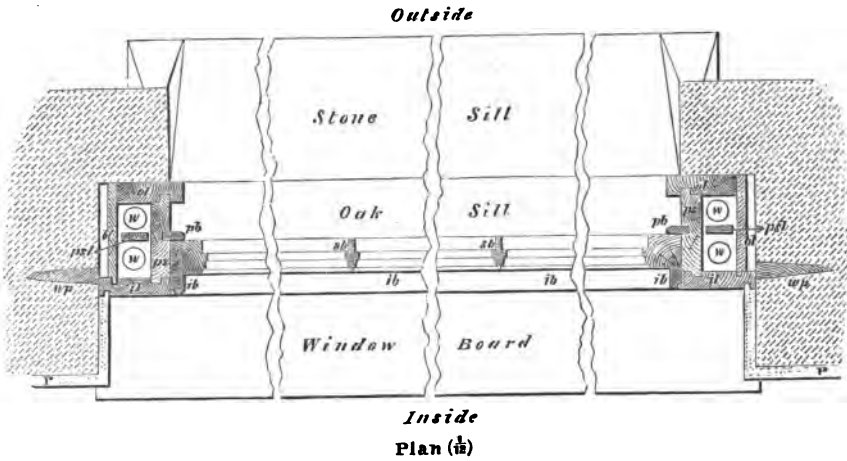

Fig. 316.

The projecting end of the outside lining, *ol*, is sometimes rounded, as shown in Fig. 322.

It will be understood that there are two sashes—an upper and a lower. The upper sash slides in the outer half of the frame, between the parting bead, *pb*, and the end of the outside lining, *ol*; the lower sash slides in the inner half of the frame, between the parting bead, *pb*, and the inside bead, *ib*.

The lower rail of the upper sash and the upper rail of the lower sash, *mr mr*, are called the “meeting rails.” They are made wider than the others (each by the thickness of the parting bead), and are bevelled off, as shown in Fig. 317 (or, in some cases, rebated), so as to fit closely where they meet.

The bottom rail of the lower sash is made deeper than the others. It fits the upper surface of the oak sill, and the lower surface of the rail is sometimes throated to prevent wet from driving under it.

Occasionally the throat is formed nearly on the extreme front edge of the bottom rail, as shown in Fig. 315, so that when closed it is immediately in front of the throat upon the oak sill described at page 109.

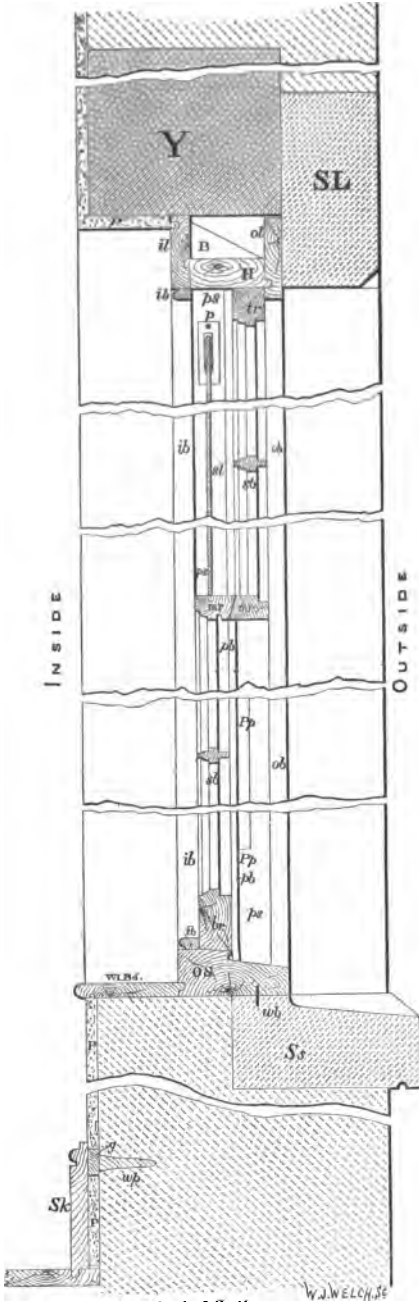

Vertical Section.
(1/2)
Fig. 317.

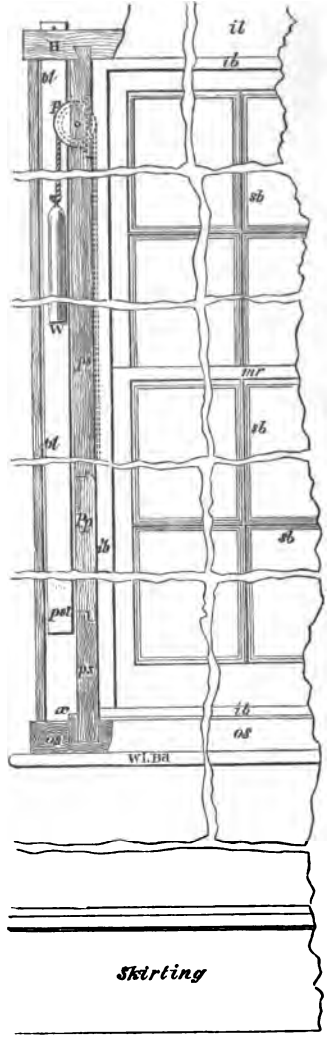

Elevation of part of Interior (1/2)
(the inside lining having been removed)

Fig. 318.

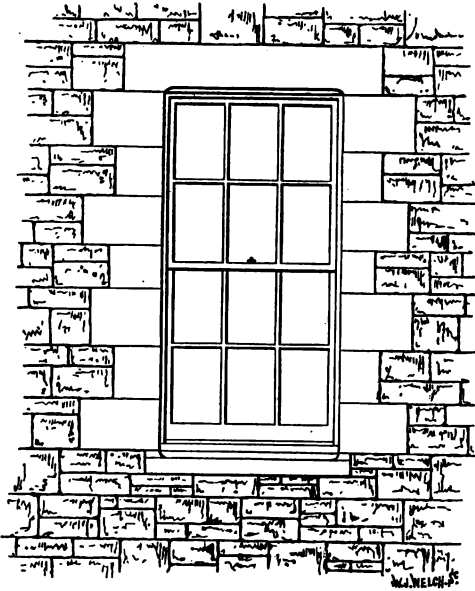

Fig. 319.

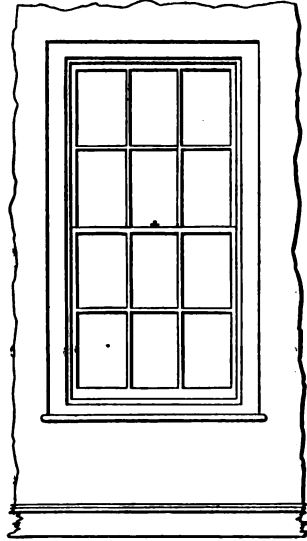

Fig. 320.

The lower surface of the bottom rail is sometimes checked out to fit the oak sill (see Fig. 321), and its back edge slightly splayed, so as not to strike the inside bead as the sash is lowered. The outer side of the inside bead may also be splayed to fit the lower side, so that the joint between them is tightened as the sash descends.

The *sill* is similar to that already described at page 190. A notch is formed in its upper surface to receive the lower end of the parting bead. The penetration of water between it and the stone sill upon which it rests is prevented by a metal water bar, as previously described.

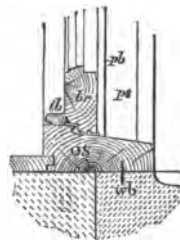

Fig. 321.

The upper parts of the styles of the sashes have grooves taken out of their sides about $\frac{1}{2}$ inch square, and extending downwards about 6 inches from the top, to receive the ends of white flax ropes or "*sash lines*," (about $\frac{3}{8}$ inch in diameter); these pass over brass pulleys, *pp* (Figs. 317, 318), fixed in slots near the top of the pulley styles, are attached to the weights, *ww*, which counterbalance the sashes.

The direction of the sash line in Fig. 318 is shown by the

dotted line. The lower end of the line, after passing through the groove in the sash style above mentioned, enters a hole bored obliquely inwards for 3 or 4 inches in depth, until it meets a larger hole sunk in the side of the style, in which it is secured by a knot which is nailed to the style. This knot is not shown in Fig. 318, as it would occur just where the figure is broken.

The weights are of common cast-iron, 14 to 24 inches long, and either circular or rectangular in section. The weights should be together slightly lighter than the sash, and they hang in the boxes, being separated (to prevent them fouling) by the *parting slip*,¹ *psl.*

The upper end of the parting slip is passed through the head of the frame and secured by a nail driven through it, as shown in Fig. 318.

Nearly at the foot of each pulley style a rectangular hole is cut to admit the weights, which can thus be got at whenever necessary.

This hole is called the "*pocket*," and is covered by a flush lid or "*pocket-piece*,"² the lower end of which is rebated, and the upper side both rebated and undercut, so as to fit into the pulley style (see *Pp*, Fig. 318).

The pocket is sometimes placed in the centre, immediately behind the parting bead, as in Fig. 317, but it is more convenient and easier to open if placed in the pulley style, forming the face of the inner box (see Fig. 316), so that it is just behind the lower sash when closed.

To open the window the lower sash is thrown up or the upper one pulled down. When the window is closed, the sashes are secured in position by a small clip or sash fastening fixed on the meeting rails.

In the example shown in Fig. 317, the inside lining above the head is stiffened by a bracket, *B*; very often a small block is placed in each of the lower corners for the same purpose, as in Fig. 322.

As this part of the course does not include linings of any description, the case selected for illustration in Figs. 316, 317, is one of a window in a thick wall of a somewhat inferior building. The jambs inside the window are merely plastered, whereas in a superior building they would be lined, as described in Part II.

The ledge formed by the thickness of the wall within the sill is however protected by a window board, *Wi Bd*, tongued into the back of the sill, and grooved to receive the edge of the plastering.

¹ Sometimes called *Pendulum Slip*.

² *Ir. Fozing*.

The inside lining is also grooved for a similar purpose.

CASED FRAME WITH DOUBLE-HUNG SASHES IN A THIN WALL.—Even in superior buildings windows may necessarily be fixed without linings. This occurs when the wall is thin, affording barely space for the boxed frame, together with a sufficient thickness of brickwork for the reveal.

Fig. 322 is a section of the upper portion of a window, in 9-inch brick wall.

The joint between the inside lining and the plaster is covered by an architrave, A, the description of which does not fall within the limits of this course, but will be given in Part II.

The frame is secured in position at the sides by being nailed obliquely through the inside lining to wood bricks built into the reveal, and at the head by being nailed through the inside lining to the wood lintel.

In this case the head is furnished with a top lining, *tl*, which sustains the inside lining, and a bracket similar to that in Fig. 317 is therefore unnecessary.

It will be seen that Figs. 317 and 322 give illustrations of the different methods in which the weight of the back of the wall above the opening is supported. In Fig. 322 there is a wood lintel, WL, relieved by a rough segmental arch of the description shown in Fig. 88. In Fig. 317, Y is a flat arch for which a concrete beam is sometimes substituted, thus in either case dispensing with the wood lintel, the evils of which have been pointed out at page 10.

If the method illustrated in Fig. 322 were applied to the thicker wall, shown in Fig. 317, two wood lintels would be required to support the back of the wall above the opening. Such a case is shown in Fig. 313. The under sides of the wood lintels are either hacked or lathed to form a key for the plaster soffit; or in superior work they are covered by a wooden soffit lining, as described in Part II.

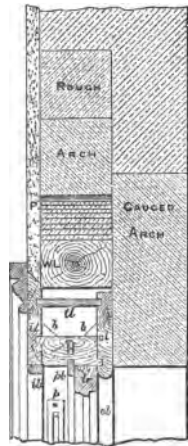

Fig. 322.

Fixing Cased Frames in Position.—Cased frames are generally secured in position by wedges, or pairs of wedges, driven in at the sides between the back linings of the boxes, or casings, and the masonry; and at the head by wedges between the top of the frame and the soffit of the relieving arch or lintel. (These last-

mentioned wedges should be driven in over the pulley styles, so that they may not bear upon the unsupported part of the head of the frame and cause it to bend.) The frame should, however, be made more secure at the sides by being nailed obliquely through the inside linings, and wedges where they occur, to plugs or wood bricks inserted at intervals in the masonry or brickwork (see Figs. 85, 86, 316), and at the top by being nailed to plugs inserted in the inner flat arch, or directly to the concrete or wood lintel, according to the construction adopted. When the inside lining is attached to the wood lintel, it should be nailed only near the ends of the lintel where it bears upon the wall, so that the lintel may be free to sag in the centre without bearing on the frame.

Cased frames are often built in as the walling progresses, in which case the head should be made longer than the width of the frame, so as to form *horns* somewhat similar to those of the solid door frame shown in Fig. 309.

SINGLE-HUNG SASHES.—These are constructed in exactly the same manner as those just described, and so are the frames to contain them; but the upper sash, instead of being suspended, is fixed, and prevented from descending, by stops nailed under its bottom rail, the lower sash being hung with counterbalance weights, as above described.

In some cases, however, it is more convenient to fix the lower sash, the upper one being hung in the usual manner.

French or Casement Windows are those in which the sashes are hinged vertically and open like a door.

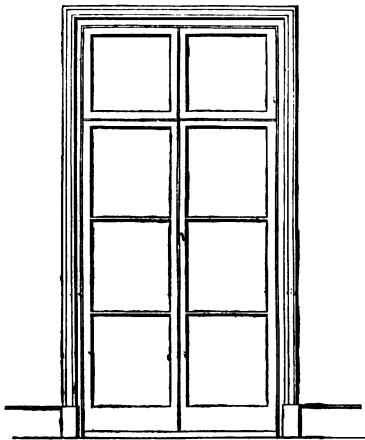

Inside Elevation

Fig. 323.

In exposed places they should be made to open outwards, as then the wind pressing upon them from the outside only makes them close more tightly.

The frames for these windows are solid, having a rebate cut round the outside to receive the sash.

The back of the hanging style of the sash is generally shaped so as to fit into a circular recess formed in the frame, as shown at *x*, Fig. 321, in order to make the joint as tight as possible.

These sashes have continuous horizontal bars, the vertical bars, if any, being framed into them.

It is difficult to keep the wet from entering these windows, especially if the sashes are hung folding in two leaves.

To prevent this various methods have been devised; among the best is the curved groove on one style and corresponding projection on the other fitting into it, as shown in the figure.

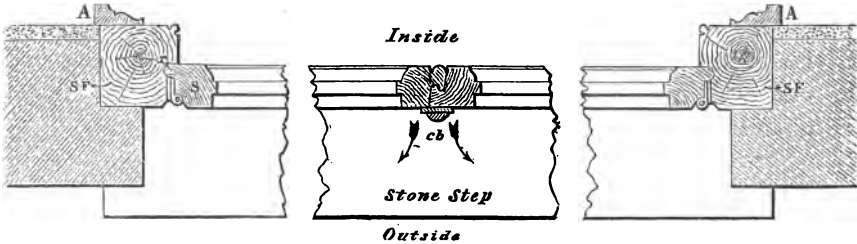

Fig. 324.

The joint is often further projected by a cocked bead, *cb*, planted on the outside.

The frames of casement windows are often placed so as to be flush with the face of the wall, in order that the sashes may fold back against the wall when open.

When a casement window extends down to the floor it becomes in fact a glass door, and is often made to open inwards; in such a case it is very difficult to keep water from entering between the foot of the door and the sill, which, if rabbeted, is so necessarily on the inside. To overcome this objection several different plans have been adopted.

One of these is shown in Fig. 322. The rain is prevented as much as possible from beating in at the joint by a moulded and throated weather board, and by a metal water bar fixed in the oak sill. Any wet that may penetrate between these is caught in the groove formed in the sill at the back of the water bar, and conveyed away through a hole bored in the oak sill as dotted.

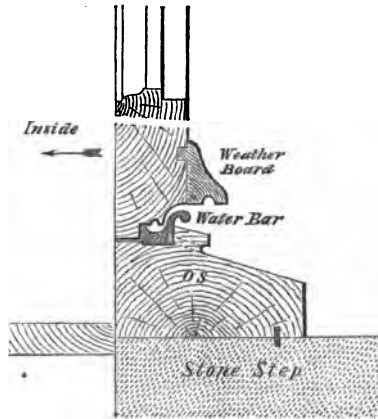

Fig. 325.

In this arrangement the water bar is rather in the way of any one entering the door. To avoid this it is often omitted, or "self-acting water bars" are used. These are attached to the lower rail of the sash, move with it, and when it is shut, turn over to secure the joint. Any detailed description of these contrivances would be beyond the range of this Course.

In order to get rid of the water penetrating between the frame and the sides of the sash, the rebate in the former is grooved down the centre, and a similar groove is formed down the side of the style of the sash. These two grooves meeting one another form a channel down which the water runs into the groove behind the water bar above noticed.

Furniture and Hinges.—The description of the different kinds of furniture and hinges in use does not fall within the range of this course, but it is required that the student should know the position in which they are fixed (see Syllabus).

Position of Furniture.—**DOORS.**—The "furniture" of a door depends upon the situation and nature of the door itself.

There are several kinds of locks and fastenings in use, of which a few only can here be mentioned, and none described. The former are fixed in or upon the lock rail, at a convenient height for the hand. The position for fastenings varies according to their description and the use for which they are intended.

For ledged, framed and braced, or other common doors, the only furniture required is a *Norfolk* or *thumb latch* and a *rim lock*. These are placed as shown on Figs. 288, 292, 293.

For superior doors, such as those in the principal rooms of good houses, mortise locks, concealed in the thickness of the door, with spring bolts and ornamental knobs, are chiefly used, and also finger-plates, *fp*, fixed just above and below the lock on both sides of the door (see Fig. 299). The lower finger-plate is very often made smaller than the other. The small bolt knob shown in this figure is going out of fashion; when used its position varies. It is sometimes in a line with the large knob, or slightly above or below it, according to the make of the lock.

The edge of the keyhole is often protected by a brass plate or *escutcheon* screwed on over it, and having a hole in it coinciding with the keyhole. Dust and dirt are excluded by the use of a small hanging cover (see *e*, Fig. 299) pivoted above the keyhole.

For common or external doors heavier locks are required. These are generally iron-cased *rim locks* (see Figs. 295, 307), or

for some doors wooden *stock locks* of an ornamental exterior are used.

External doors require to be further secured by *barrel bolts*, either horizontal, or (when hung folding) by vertical bolts at the top and bottom sliding into the head and sill respectively (see Fig. 307).

Chain and barrel fastenings are also required on the inside of outer doors, in order that they may be secured when partially open. The plate at one end of the chain is screwed to the door frame, while a knob at the other end slides in a hollow barrel fixed to the door.

Position of Hinges.—This is shown for the *cross garnet hinges*¹ on the ledged doors in Figs. 288, 290, also for the *strap hinges* in Fig. 292, and for the *butt hinges*² in Figs. 295, 299, 307.

In framed doors the upper hinge is fixed on the edge of the style just below the level of the lower edge of the top rail, in order to be clear of the tenon of the rail; for the same reason the lowest hinge is placed just above the level of the bottom rail. When there are three hinges, the intermediate one is placed half-way between the others.

The knuckle of the hinge may be placed so as to coincide with the bead on the door-frame, as in Fig. 307. This is often done in good work to preserve the appearance of the bead intact, but a very general practice is to let half the knuckle into the door, as in Fig. 299, the remaining half being let into the frame.

To enter upon the different methods of fixing hinges would require long descriptions and diagrams; the subject is a somewhat intricate one, and does not form a part of this course.

Windows.—The different fastenings in use for sashes, shutters, etc., are so numerous that it will be impossible to do more than notice one or two that are absolutely necessary.

Sliding sashes require a spring clip or *sash-fastener* to keep the meeting rails in their proper position when the window is closed; in some cases this is done by driving a *thumbscrew* through the meeting rails.

The lower sash, if heavy, should be provided with small brass handles or *lifts* screwed to the lower rail.

Casement windows require fastenings to secure the sashes when shut, and also to hold them back when open. The latter are fixed in the face of the wall when the sashes fold back upon it,

¹ Sc. *Cross-tailed Hinges.*

² Sc. *Edge hinges.*

but if they only open at right angles the fastenings are on the sill.

A common form in this latter case is a flat iron bar pivoted to the sash, with holes throughout its length which fit upon a pin fixed on the sill. The position of the hole selected regulates the degree to which the sash is opened.

When hung folding, a vertical *flush bolt* is required at the top and another at the foot of the style of the sash first closed.

Sometimes there are top and bottom bolts connected by a rod, so arranged that the turn of a handle in the centre shuts both bolts, and also secures the sashes to one another. This is known as the "*Espagnolette bolt*."

Sashes hung on centres, when out of reach, have a cord attached to the top and bottom rails, and secured to a belaying pin below; or, if they can be easily got at, they may be secured either when open or shut by the quadrant fastening above described.

INDEX.

A

Abutments of arches, 4.
Abutment cheeks of tenon, 66.
 " circular, 73.
Angle bead, 171.
Apertures in walls, 8.
Apex stone, 54.
Apron lead, 155, 156.
Arches, 3; ashlar, 47; axed, 28;
 brick, 27; centre for, 47; differ-
 ent forms of, 5; Dutch or French,
 31; gauged, 28; inverted, 6;
 names of parts, 4; over openings
 in external walls, 29; over open-
 ings in internal walls, 31; rough
 cut, 28; rubble, 47; saving,
 6, 52; stone, 47.
Architraves, 52, 170, 181, 193.
Arris, 40.
Ashlar arches, 47; masonry, 37, 39,
 41; hammer-dressed, 46; facing,
 46; arches, 46.
Astragal, 194.
Axed arches, 28.

B

Back boxing, 198.
 " of an arch, 4.
 " lining of sash frame, 193, 198.
 " of rafters, 70.
 " of slates, 142.
Bale tacks, 160.
Balustrade, 7, 55.
Band, 2.
Barred door, 181.
Barrel bolts, 207.
Bars, 181.
Bat, 13; three-quarter bat, 14.
Bats, lead, 154.

Battens, 108, 121; slating, 142;
 tilting, 108, 146.
Batter, 12.
Baulk, 111.
Bay, 84, 113, 120.
Bead butt, 179; flush, 199.
Beaded joints, 174.
Beads, different kinds, 171.
Beam and post joints, 73; beam and
 strut joints, 73.
Bed of slates, 142.
Bed plug, 48.
Berge, 157.
Bevelled halving, 63; heading, 96.
Binders for floors, 82, 84, 85; for
 roofs, 108.
Binding joists, 84; scantlings of,
 101; rules for scantling of, 102.
Birdsmouth, 73, 121.
Blocking course, 7, 55, 108.
Block in course, or blocked course
 46.
Board eaves, 146.
 " windows, 193, 202.
Boarding of floors, 82.
 " of roofs, 108, 113, 121.
 " sound, 90.
 " matched, 173.
Bolts, 77.
Bond, general remarks, 2; of brick-
 work, 13; dogs-tooth, 38; Eng-
 lish, 15; Flemish, 17; heading,
 15; of masonry, 38; stretching,
 15.
Border, oak, 85.
Bossed up, 161.
Bottled-nosing, 153.
Bottle-nosed drips, 154.
Bottom rail of door, 185; of sash,
 193.

- Bottom panel of door, 185.
 " runner, 104.
 Bound, 177.
 Box gutter, 161.
 Boxed frames, 193.
 Boxes, drip, 164.
 Brace and tie joints, 74.
 Braces, 104, 118, 181.
 Bracket, 193, 202.
 Brads, 171; flooring, 97.
 Branched straps, 80.
 Brandering, 100.
 Breeze for concrete lintels, 10.
 Bressummers, 10, 168.
 Bricknogged partition, 103, 107.
 Bricks, concrete, 11.
 " pallete, 11.
 " size of, 12.
 " wood, 10, 181.
 " " substitutes for, 11.
 Brickwork, general remarks on, 12;
 meaning of terms connected with,
 13; bond of, 13.
 Bridged gutter, 161.
 Bridging joists, 82, 89; scantlings of,
 101; rules for scantling of, 102.
 Bridle, Bridling, 91.
 " joints, 72.
 Brimstone, 48.
 Broken joint floors, 96.
 Bulb-iron rafters, 135.
 Burning in lead, 155.
 Butt joints, 173.
 " hinges, 206.
- C
- Calf, 62.
 Camber arch, 5.
 Cantilever, 123, 168.
 Cap, 54.
 Capital, 54.
 Capping, 193.
 Carpentry, joints and fastenings in, 56.
 Case bay, 84.
 Cased frames, 193, 202; parts of,
 198.
 Casement windows, 204.
 Cast-iron cantilever, 168.
 " girders, 168.
 " shoe, 80, 86, 190.
 Cast-iron strut, 126.
 Caulking, 65, 155.
 Ceiling joists, 82, 99, 108, 122;
 rules for scantling of, 102.
 Cement filleting, 166.
 Centre for arch, 47.
 Cesspools, lead, 164.
 Chain and barrel fastenings, 207.
 Chair, iron, 135.
 Chamfered panel, 180.
 Chamfering, 40, 172.
 Chamfer, stop, 172.
 Channel iron rafters, 135.
 Chase, 1.
 Chase-mortise, 71, 99.
 Check, 93.
 Cheeks of mortise, 66.
 Circular joints, 72, 73.
 Cisterns, 167.
 Cleats, 108, 119.
 Closers, 13.
 " queen, 13.
 " king, 14.
 Club-skew, 54.
 Cocked bead, 171.
 " and fillet, 171.
 Cogging, 65.
 Collar beam, 108, 110, 125.
 Common dovetail joints, 175.
 " joists, 82, 89.
 " partitions, 103, 106.
 " rafters, 108, 120.
 Concrete lintels, 10.
 Conductors, 165.
 Consoles, 123.
 Cope, 6.
 Copings, 6.
 " brick, 35.
 " stone, 53.
 Corbelling, 8, 36.
 Corbels, 53, 88, 108.
 Core, 52.
 Corking, 65.
 Cornice, 6, 108.
 " brick, 35.
 " masonry, 37, 54, 55.
 Corrugated iron arched roof, 130.
 Cottered joints, 136.
 Cotters, 116, 132, 136.
 Countess slates, 143, 148.
 Couple-close roof, 110.

Couple roof, 109.
 Coursed header work, 44.
 Courses, eaves, 7, 35, 53.
 " lacing, 46.
 " strung, 36, 53.
 Coursing joints of arches, 5.
 Coverings for iron roofs, 140.
 Cover of slates, 142.
 Cramps, metal, 49.
 Cross bars, 181.
 " garnet hinges, 207.
 " tailed hinges, 207.
 " grooving, 173.
 Crown of arch, 4.
 Current, 150.
 Cupple, 109.

D

Deafening, 90.
 Discharging arches, 5.
 Dog-ear joint, 161.
 Dog's-tooth bond, 38.
 Dooks, 10.
 Door frames, 190.
 Doors, 180; framed and braced, 182;
 furniture of, 206; ledged, 181;
 ledged and braced, 182; method
 of putting together, 185; panelled,
 183; sliding, 190.
 Door sills, 9.
 Door studs, 105.
 Dots, lead, 155.
 Double angle-iron rafters, 135.
 " bar-iron rafters, 135.
 " floors, 82, 84.
 " margined doors, 190.
 " notching, 64.
 " quirked bead, 171.
 " shoe for struts, 81.
 " tenons, 68, 176, 185.
 Doubles, 148.
 Doubling, 157, 166.
 " eaves course, 146.
 Dovetail halving, 63.
 " joints, 63, 175.
 " notch, 64.
 " tenon, 68.
 Dovetailed slip feathers, 174.
 Dowelled joints, 48, 173, 190.
 Down-comers, 165.

Down pipes, 165.
 Drafted margin or draft, 39
 Draft, sunk, 50.
 Drawboring, 76.
 Drip boxes, 164.
 Drips, 150, 154.
 Duchess slates, 122, 140, 148.
 Dutch arches, 31.
 Dwangs, 104.
 Dwarf walls, 83.
 Dykes, 1.

E

Eaves, 120, 122.
 " course, 7, 35, 53, 146.
 Edge hinges, 207.
 " rounded, 171.
 Edges, shot, 93.
 Eking, 100.
 Elliptic arch, 5.
 Empreses, 148.
 English bond, 15.
 " with broken transverse
 joints, 17.
 " compared with Flem-
 ish, 24.
 " inferior forms of, 24.
 Escutcheon, 206.
 Espagnolette bolt, 208.
 Extrados of arch, 4.

F

Fascia, 108.
 " bond, 123.
 Fastenings in carpentry, 76.
 Feather-edged coping, 54.
 Feather, slip, 173, 177.
 Fielded panel, 180.
 Filletings, 166.
 Fillets, 82, 99, 193.
 " slate, 146; cement, 166.
 Fillet-tilting, 108, 146.
 Fillistered joint, 94.
 Fillistering, 97.
 Finger-plates, 206.
 Firrings, 82, 100.
 Fishing, 57, 58.
 Fish pieces, 58.
 " plates, 58, 62.
 Fixing lead to masonry, 154.

- Fixing cased frames, 203.
 Flanges of girders, 168.
 Flanks, 152.
 Flashings, 155.
 " lead, horizontal, and raking, 157.
 " lead, substitutes for, 166
 " cement, 167.
 " skeleton, 159.
 " stepped, 159.
 Flat roof, 108.
 Flats, 150.
 Flemish bond, 20.
 " double, 21.
 " double, with false headers, 21.
 " single, 22.
 " comparison with English, 24.
 Flint rubble, 45.
 Flitch girders, 87.
 Flooring, naked, 82.
 Floors, classification, 82.
 " double, 82, 84.
 " folded, 97.
 " framed, 84.
 " general remarks, 98.
 " girders, 87.
 " in two thicknesses, 97.
 " joists, 89; do., ceiling, 99.
 " names of parts, 82.
 " of short timbers, 99.
 " parquet, 98.
 " pugging, 90
 " single, 82.
 " strutting, 89.
 " templates, 89.
 " trimming, 91.
 " wall plates, 88.
 Floor boards, 93.
 " nailing, 97.
 Flushed joint, 40.
 Flush bead, 171.
 " panel, 178.
 " bolt, 208.
 Folded floors, 97.
 Folding doors, 188.
 Footings, generally, 6.
 " in brickwork, 33.
 Forked heading joints, 96.
 Foxing, 202.
 Fox wedging, 75.
 Frame—Door, 190.
 " Window, 193.
 " " cased, 198, 203.
 " " solid, 194.
 Framed and braced door, 182.
 " ledged door, 183.
 Framed floors, 82, 84.
 " gutter, 161.
 " partitions, 103.
 Frames, cased, 193, 202; fixing, 203.
 Framing in joinery, 177.
 French arches, 31.
 " windows, 204.
 Frieze rail, 185.
 Furniture, 206.
 Furrings, 82, 100.

G

 Galleting, 45.
 Gathering over, 8.
 Gauge of slating, 142, 148.
 Gauged brickwork, 27.
 Gibs, 116, 137.
 Girders, 82, 84, 87; cast-iron, 168.
 " table of scantlings of, 102.
 " " rules for scantling of, 102.
 Gothic arch, 5.
 Groined arches, 5.
 Grooved and tongued joints, 49, 95, 173.
 Grooved panel, 179.
 Grooving-plough, 173.
 " cross, 173.
 General remarks on ashlar masonry, 39.
 " " floor boards, 96.
 " " floors, 98.
 " " iron roofs, 141.
 " " joinery, 170.
 " " masonry, 37.
 " " partitions, 103.
 " " rubble masonry, 42.
 " " timber girders, 87.
 Grounds, 170, 181, 193.
 Gutter, 108, 123, 160; bearer, 108, 161; box, 161; bridged, 161; eaves, 164; framed, 161; iron, 164; lead, 160; middle, 152; parallel, 161; plate, 108, 162;

- stone, 164 ; trough, 161 ; V, 161 ; valley, 164 ; zinc, 165.
- H
- Half-slating, 149.
Halving, 62.
" bevelled, 63.
" dovetail, 63.
Haunches of arch, 4.
Haunching, 176.
Head of partition, 104.
" slates, 142.
" " bond, 15.
Heading joints of arches, 5.
" " floors, 95.
" courses in brickwork, 13.
Headers, 3, 13.
Heads, 8.
" iron roofs, 139.
" of door frame, 190 ; of sash frame, 193.
Herring-bone strutting, 90.
Hinges, 181, 193, 206, 207.
Hips of roofs, 124, 146, 166.
Holdfasts, 165.
Hollow nosing, 153.
" rolls, 152.
Hoop iron bond, 26.
" " tongues, 173.
Horn of tusk tenon, 67.
Horns of door frame, 106, 190 ; of cased frames, 204.
Housing, 68, 172.
- I
- I section of iron, 135.
Imperial slates, 148.
Inbond, 3, 41, 51.
Incomes, 8.
Inside bead, 193, 198.
" lining of sash frames, 193, 198
Intake, 7.
Intertie, 105.
Inverted arches, 5.
Iron roofs, 128.
" classification of, 130.
" corrugated, arched, 130.
" general remarks on, 141.
" gutters, 164.
- Iron roofs, parts of, 134.
" principal rafters, 134.
" queen rod, 133.
" scantlings for, 141.
" straight rafters, 131.
" trussed rafter, 131.
" tie rods, 135.
Iron trusses, parts of, 134.
Ironwork built into masonry, 39.
- J
- Jambs of arches, 4.
" in apertures generally, 8.
" in brickwork, 32.
" in masonry, 51.
Jib doors, 190.
Jibs. *See* Gibs.
Joggle, 49.
Joggled joints, 48, 68.
Joinery, general remarks, 170 ; framing, 177 ; joints of, 173.
Joints and connections in masonry, 48.
Joints and connections in carpentry, 56.
Joints, butt, 93.
" dog-ear, 161.
" flushed, 40.
" heading, 95.
" in floor boards, 93-96.
" in joinery, 173-177.
" plain, 93.
" rebated, 50, 54.
" saddled, 55.
" in sheet lead, 152-154.
" water, 55.
Joists, bridging, 82, 89.
" ceiling, 82, 99.
" common, 82, 89.
" trimming, 82.
Junction of walls at right angles, 26.
" of two brick walls, 26.
" a brick and a stone arch, 27.
- K
- Kerf, 62.
Key strutting, 90.
Keys, 58, 76, 116.
Keystone of arch, 4.
Kicking strap, 79.

King bolt, 108, 137.
 " roof, 112, 124, 125.
 King piece, 117.
 King post, 108, 112, 117.
 " roof, 108, 113, 114; parts
 of, 115; scantlings of,
 123.
 King tie, 108.
 Kneeler, 54.

L

Lacing courses, 46.
 Ladies slates, 143, 148.
 Laid in, 171.
 Lap dovetails, 175.
 " of slates, 142.
 Lapped joints, 154.
 Lapping, 57.
 Latches, 181, 206.
 Latchet, 152, 160.
 Lathing, 82.
 Laths, 193.
 Laying slates, 143.
 " sheet-lead, 150.
 Lead bats, 154.
 " cesspools, 164.
 " cisterns, 167.
 " dots, 155.
 " flashings, 157; substitutes for,
 166.
 " gutters, 160.
 " ridges and hips, 165.
 " sheet, in masonry joints, 40.
 Lean to, 109.
 Ledged doors, 181.
 " and braced doors, 182.
 Ledges, 181.
 Lifts, 207.
 Limit of elasticity, 66.
 Linings, 170.
 Lintel course, 7.
 Lintels, concrete, 10, 193.
 " stone, 52, 193.
 " wood, 30, 193, 203.
 Lock, 181, 206.
 " rail, 185.
 Lower panel, 185.

M

Malm cutters, 27.

Marchionesses, 148.
 Margin, drafted, 39.
 Margin of slates, 142.
 Masonry, general remarks, 37; arches,
 47; bond of, 38; joints and
 connections, 47.
 Matched boarding, 173.
 Meeting rails, 193, 198.
 Metal connections for masonry, 48.
 Middle gutter, 152.
 Middle rail, 185.
 Mitred dovetail joints, 175.
 Mixed roofs, 130.
 Mortise, 65.
 " and tenon joints, 65, 175.
 " chase or pulley, 71.
 Moss, 91.
 Moulded and flat, 178.
 Mouldings, 171.
 Mounter, 185.
 Munting, 185.

N

Nails, 77; slating, 145.
 Nailing floor boards, 97.
 " secret, 98.
 " slates, 144.
 Natural bed of stone, 37.
 Neutral axis, 66.
 Nogging pieces, 104.
 Norfolk latch, 206.
 Nosings, 153, 171.
 Notching, 63, 99.

O

Oak sill, 193.
 Oblique tenon, 69.
 Oncomes, 8.
 Open slating, 148.
 Ornamental slating, 148.
 Overflow-pipes, 162.
 Outbond, 3, 41, 51.
 Outside lining of sash-frames, 193,
 198.

P

Pallette bricks, 11.
 Pallets, 10.
 Panelled doors, 182.

- Panelled doors, different descriptions, 187.
 Panelling, 177 ; different kinds of, 178 ; names for, 178, 180.
 Parabolic arch, 5.
 Parallel coping, 54 ; gutter, 161.
 Parapet wall, 7, 55, 108.
 Parquet floors, 98.
 Parting bead, 193, 198 ; parting slip, 193, 202.
 Partitions, 103 ; bricknogged, 107 ; common, 106 ; framed, 104 ; quartered, 104.
 Pedestals, 55.
 Pendulum slip, 202.
 Perpend, keeping the, 12.
 Piers of arches, 4.
 Pinhole of mortise, 66.
 Pinning, 67, 77.
 Pipes, down, 166.
 Pitch of roofs, 109, 140.
 " of slating, 142.
 Planted, 171, 180.
 Plastering, 82, 193.
 Plates, 78.
 " fish, 58, 62.
 " pole, 108, 113, 121.
 " tie beams, 80.
 " wall, 10, 82, 88, 108, 113, 115.
 Pocket, 202 ; pocket-piece, 202.
 Pole plate, 108, 113, 121.
 Polling, 45.
 Polygonal or rustic rag-work, 45.
 Popples, 45.
 Post and beam joints, 73.
 Plain joints, 93, 173.
 Planceer, 122.
 Plinth, 7.
 " rusticated, 41.
 Ploughed and tongued joint, 94, 173.
 Plugs, bed, 48.
 " lead, 49.
 " wood, 10, 32, 181.
 Plumbers' work, 150.
 Posts, principal, of partitions, 105.
 Preparing and laying slates, 143.
 Princess slates, 148.
 Principal posts of partition, 105.
 Principal rafters of wooden roofs, 108, 119 ; of iron roofs, 134.
 Principal tenons, 111, 113.
 Proper ledged door, 181.
 Pug-boarding, 90.
 Pugging, 82, 83, 90.
 Pulley, 193.
 " mortises, 71.
 " style, 193, 198.
 Purlin for wooden roofs, 108, 113, 119.
 " iron roofs, 139.
 Putty, 27, 39.
- Q
- Quarry face, 50.
 Quartered partition, 103, 104.
 Quarterings, 104.
 " double, 105.
 Quarters, 104.
 Queen-bolt roof, 126.
 " rod roof, 129, 133.
 " slates, 148.
 Quirk, 171.
 Quirked bead, 171.
 Quoins, 6, 34, 50.
 " squint, 6.
 " rusticated, 41 ; second, 51.
- R
- Rabbeting, 93.
 Rafters, 108, 119, 120, 126.
 Raglet, 55, 154.
 Raglins, 99.
 Rag slates, 148.
 Rails, 177, 181, 185.
 " names of, 185.
 Rain-water pipes, 165.
 Raised panel, 180.
 Raking flashings, 157.
 Rebated joints, 50, 54, 93, 174.
 " grooved and tongued joint 94, 96.
 Reeding, 171.
 Reed flush, 179.
 Rendering, 147.
 Reveals of opening, generally, 8, 192.
 " " in brickwork, 32.
 Rhones, 164.
 Ridge courses, 146.
 " piece, 108, 113, 115, 120.
 " pole, 120.
 " stone, 54.

Ridges, 165.
 Ridging slate, 146.
 " tile and pottery, 147.
 Rim lock, 206.
 Ring courses of arches, 5.
 Rise of arch, 5.
 Rolls, lead, 150, 152.
 Roofs, collar beam, 110, 125.
 " couple, 109.
 " couple-close, 110.
 " flat, 108.
 " king-bolt without struts, 112.
 " king-post, 113, 114.
 " timber, 108.
 " timber, parts of, 108.
 " " scantlings of, 123.
 " wood and iron, 124.
 " king-bolt, 124.
 " queen-bolt, 126.
 " trussed rafter, 126.
 " iron, 128.
 " " corrugated arched, 130.
 " " general remarks on, 141.
 " " scantlings for, 141.
 " " straight rafters, 131.
 " " trussed rafters, 131.
 Root of tenon, 66.
 Rough-cut axed arches, 28, 193.
 Rounded edge, 171.
 Rubbers, red, 27.
 Rubble masonry, 37, 42 ; different kinds of, 42-46.
 " arches, 47.
 Rustic or polygonal rag-work, 45.
 Rules for scantlings, floor timbers, 102.
 Runs, 164.
 Rybates, 51.

S

Saddleback coping, 54.
 Saddle-stone, 54.
 Saddling joints, 55.
 Sagging, 83.
 Sarking, 121.
 Sashes, 193-194.
 " double hung, 198, 203.
 " fixed, 197.
 " on centres, 197.
 " single hung, 204.
 " sliding, 198.

Sash bars, 193, 194.
 " doors, 190.
 " fastener, 207.
 " line, 193, 201.
 " weights, 193, 212.
 Saving arch, 6, 52.
 Scantlings, collar-beam roof, 111.
 " couple-close roof, 110.
 " floor timbers, 101.
 " iron roof, 141.
 " partition, 107.
 " trimmers, 91.
 " trimming joists, 91.
 " wooden (king-post) roof 123.
 Scarcements, 33.
 Scares, 59.
 Scarfing, 59.
 " wall-plates, 62.
 Scarfs, 59.
 " keys in, 76.
 Scheme arch, 5.
 Screws, 77.
 Scribing, 172.
 Scuntions, 51.
 Seams, 153.
 Second quoins, 51.
 Secret dovetails, 175.
 " nailing, 98.
 Segmental arch, 5.
 Semicircular arch, 5, 30.
 Sheet-lead, 150.
 " cesspools, 164.
 " cisterns, 167.
 " flashings, 155.
 " for foot of door frame, 190.
 " gutters, 160.
 " laying, 150.
 " nosings, 153.
 " ridges and hips, 165.
 " rolls, 150.
 " seams, 150, 153.
 " valleys, 166.
 Shivers, 42.
 Shoes, iron, 80, 81, 86, 190.
 Shooting, 172, 193.
 Shot edges, 93.
 Shouldered tenon, 67.
 Shouldering slates, 147.
 Shoulders of tenon, 66.

- Shoulders of tusk tenon, 67.
 Side timbers, 119.
 " wavers, 119.
 Sill, 8.
 " course, 7.
 " door, 190.
 " of partition, 104.
 " window, 51, 193, 201.
 Single floors, 82.
 Singles, 148.
 Sizes of floor timbers, 101.
 " roof timbers, 123.
 Skeleton, flashing, 159.
 Skewback, 4.
 Skirtings, 170.
 Slate dowels, 48, 190.
 Slates, 108.
 Slate fillets, 146.
 " slabs, 148.
 " ridging, 146.
 Slating, 142.
 " eaves and ridge courses, 146.
 " for iron roof, 147.
 " half, 149.
 " nailing of, 144.
 " names of parts, 146.
 " open, 149.
 " ornamental, 149.
 " pitch, 142.
 " preparing and laying, 143.
 " rendering, 147.
 " ridging, 146.
 " shouldering, 147.
 " table of sizes and weights,
 148.
 " torching, 147.
 " Wyatt's patent, 148.
 Sleeper walls, 83.
 Sliding doors, 190.
 " sashes, 198.
 Slip feathers, 173, 175, 177.
 " joint, 1.
 Smalls, 148.
 Snapped flint work, 45.
 Snecked rubble, 43.
 Snecks, 43.
 Soakers, 160.
 Sockets, iron, 80, 81.
 Soffit, 4, 108, 122.
 Solder, 155.
 Sole, 9, 104, 194.
 Sole rail, 185.
 Solid door frames, 190.
 " window frames, 194.
 " panels, 179.
 Sound boarding, 90.
 Spall, 40.
 Span of arch, 5.
 Spandrils of arch, 4.
 Spars, 120.
 Spikes, 77.
 Splayed heading, 96.
 " joints, 8.
 Spouting, 165.
 Springing of arch, 4.
 " line of arch, 4.
 Square headings, 95.
 Square and flat panels, 178.
 Squared rubble, 43.
 Squint quoins, 6.
 Stack pipes, 165.
 Staff bead, 171.
 Stepped flashing, 159.
 Stirrup, 79, 87.
 Stock locks, 207.
 Stone gutter, 164.
 " lintel, 193.
 " sill, 193.
 Stop, 191.
 " chamfer, 172.
 Straight arch, 5, 30.
 " joint, 2.
 " " floor, 96.
 Straps, 78.
 " branched, 80.
 " heel, 79.
 " kicking, 79.
 Strap hinges, 207.
 Stretchers, 3, 13.
 Stretching bond, 15.
 " courses, 13.
 String course, 7.
 " courses of arch, 5.
 Strut and beam joints, 70.
 Struts, 108, 118.
 " iron, 126, 137.
 Strutting, 82, 89.
 Stuck, 171, 180.
 Stub tenon, 68, 73.
 Studs, 104.
 Stump tenon, 177.
 Styles, 177, 181, 185, 193.

Substitutes for wood bricks, 11.
 Sunk draft, 50.
 Suspending pieces, 74, 118.
 „ rods, 137.

T

T iron, 135, 138.
 Table, 135.
 Tabled joints, 50, 58.
 Tabling, 58.
 Tail bay, 84.
 „ of slates, 142.
 Tassels, 10.
 Templates, 10, 82, 89, 108,
 115.
 Tenon, 65, 175.
 Tenon, double, 68, 176; dovetail,
 68; haunched, 176; notched,
 69; oblique, 69; stub, 68;
 stump, 177; tusk, 67.
 Thorough bonds, 38.
 Thrawn, 173.
 Three-quarter bats, 14.
 „ headers, 38.
 Throating, 51, 193.
 Thumbats, 154.
 Thumb latch, 206.
 Thumb screw, 207.
 Tie and brace joints, 74.
 Tie beam, 108, 115.
 „ plates, 80.
 Tie joist, 115.
 „ rod, 135, 136.
 Tilting fillet, 108, 146.
 „ batten, 108, 146.
 Timber girders, 87.
 „ roofs, 108.
 Tingle, 153, 160.
 Tongued joints, 49, 95, 96, 173, 174.
 Too-fall, 109.
 Top-beam, 111.
 „ rail, 185.
 „ lining, 193.
 „ rail of sash, 193.
 Torching, 147.
 Torus, 171.
 Transom, 188.
 Tredgold's notch, 64.
 Trenails, 77.

Trenailed floor, 89.
 Trimmers, 82, 91, 121.
 „ size of, 91.
 Trimmer arch, 91.
 Trimming, 91, 124.
 „ joists, 82, 91.
 „ size of, 91.
 Trough gutter, 161.
 Truss, principal, 108.
 Trussed girders, 87.
 „ rafter roof, 126, 131, 133.
 „ „ scantlings for iron,
 141.
 Trusses, iron, 134.
 Tubular bricks with wood plugs, 11.
 Tusk tenon, 67.
 Two-leaved door, 188.

U

Uprights, 105.

V

V gutter, 161, 162.
 „ joint, 172.
 „ jointed panel, 180.
 Valleys of roof, 124, 166.
 Viscountesses, 148.
 Voussoirs of arches, 4.

W

Wall hooks, 154.
 „ pipes, 165.
 „ plates, 10, 62, 82, 88, 108,
 113, 115.
 „ plates, scarfing, 62.
 Walls, general remarks, 1; battering,
 12; dwarf, 83; sleepers, 83.
 Washers, 78.
 Water bar, 51, 193, 205.
 „ jointing, 55.
 Weather board, 205.
 Weathering, 51.
 Web, 135, 169.
 Wedges, 154, 193.
 Wedging, 75, 186.
 Weight of flooring and partitions,
 107.
 Weights of sash, 193.

- | | |
|--|---|
| <p>Windows, 192 ; boards, 193 ; frames
 cased, 193, 203 ; frames solid,
 194 ; parts of, 193 ; sizes for,
 193.</p> <p>Window sills, 9, 51.</p> <p>Wind-beam, 111.</p> <p>Winding of joints, 40.</p> <p>Wood bricks, 10, 193.
 ,, built into walls, 9.</p> | <p>Wood lintel, 193, 203.
 ,, plugs, 10, 181, 193.
 ,, slips, 10.</p> <p>Wyatt's patent slating, 148.</p> <p style="text-align: center;">Z</p> <p>Zinc laying, 150.
 Zinc nails, 145.</p> |
|--|---|

END OF PART I.

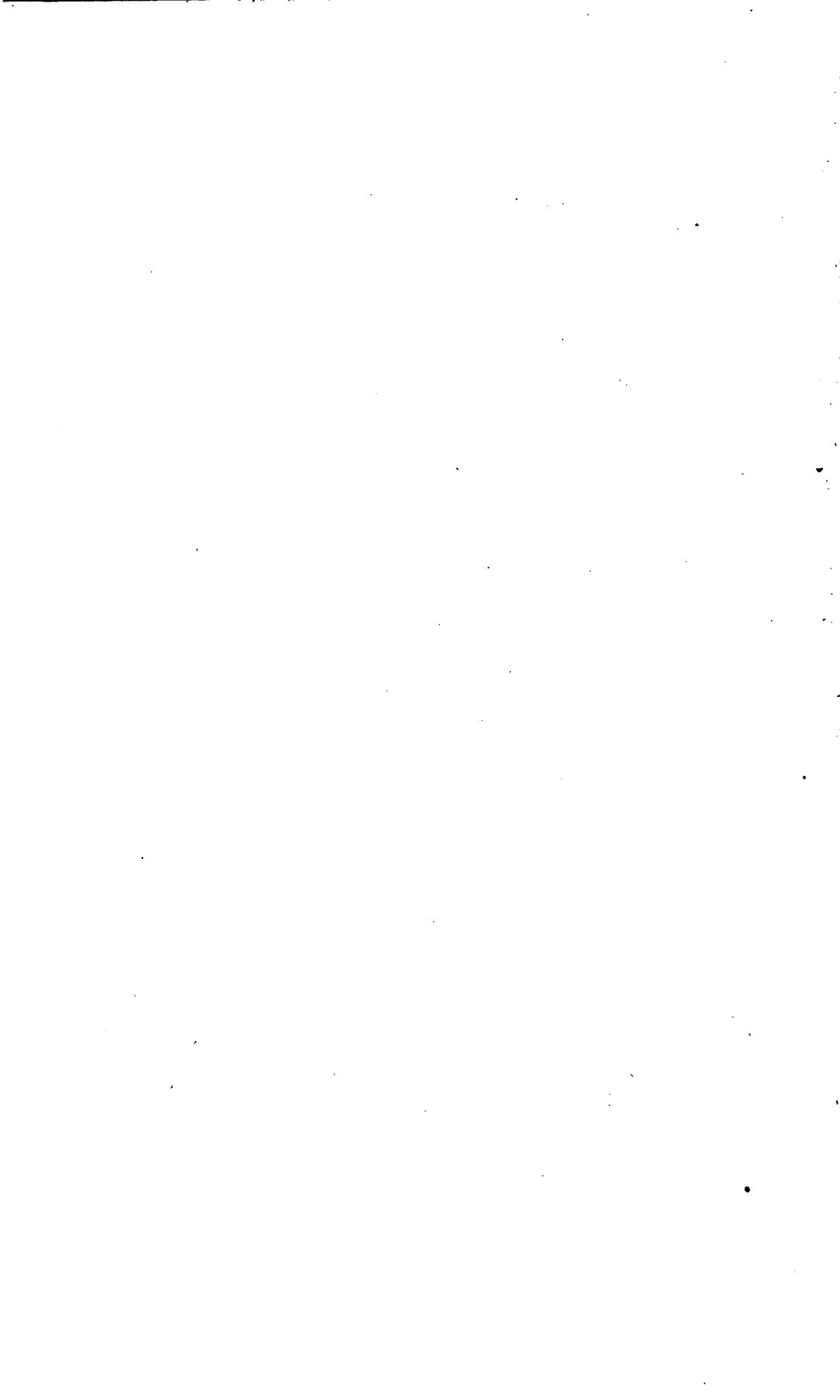



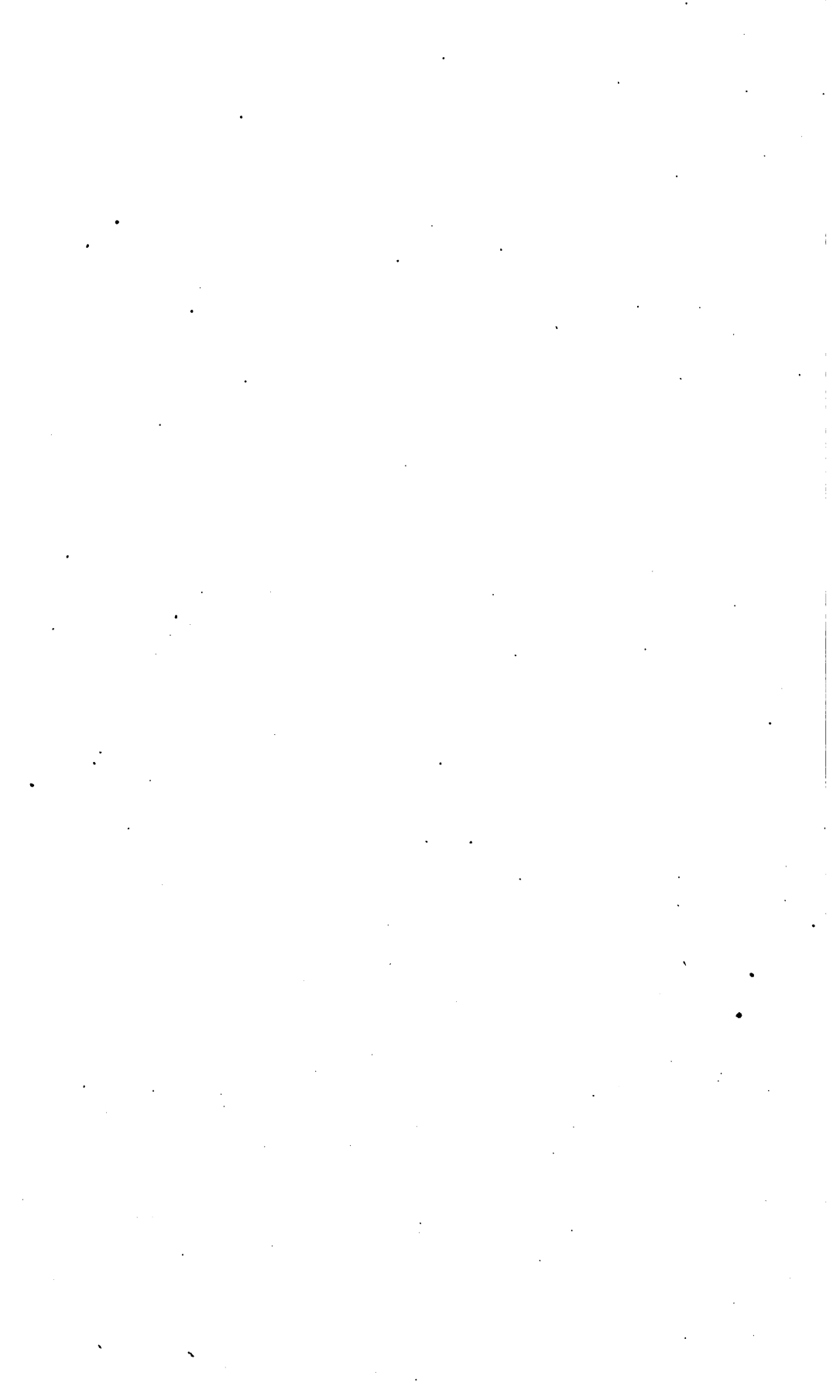

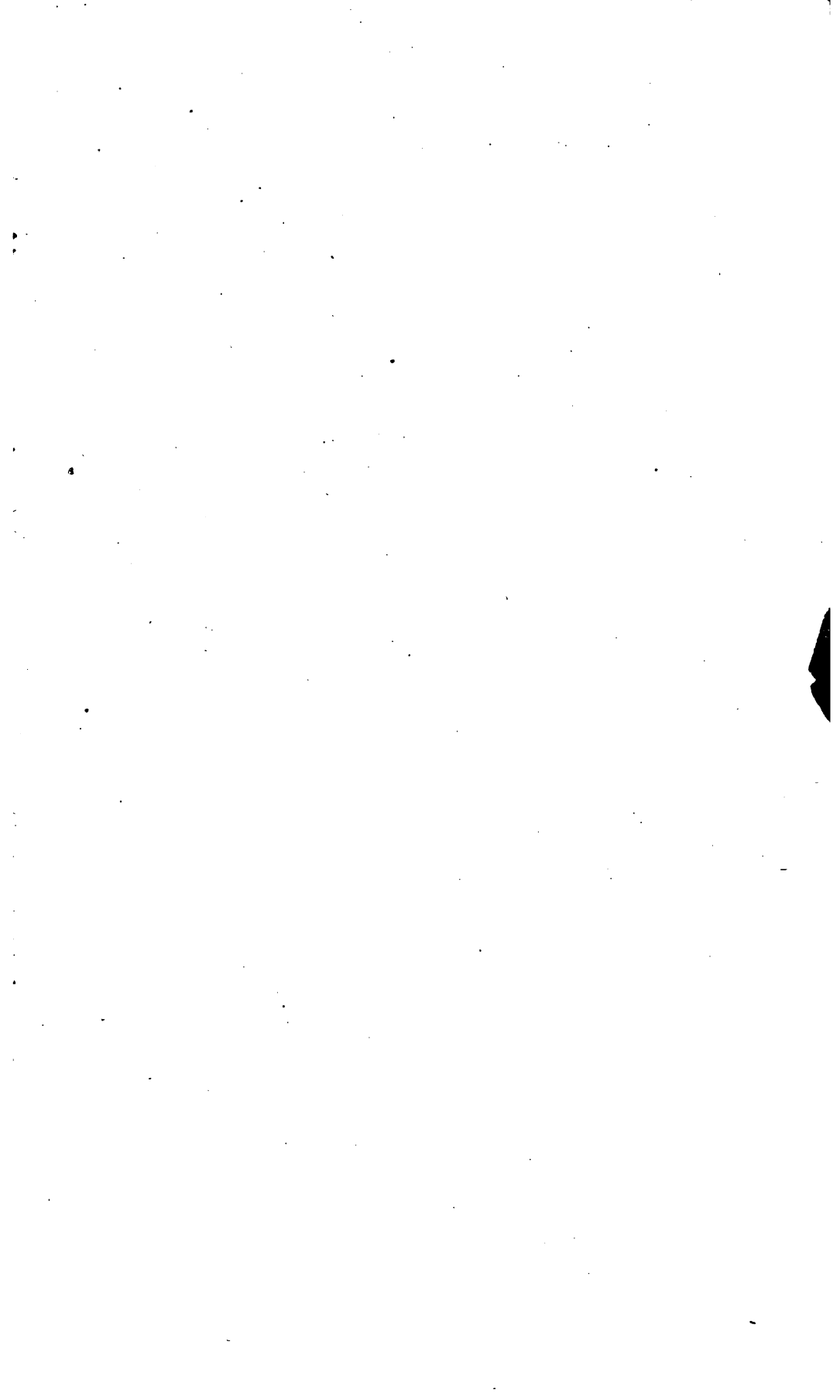

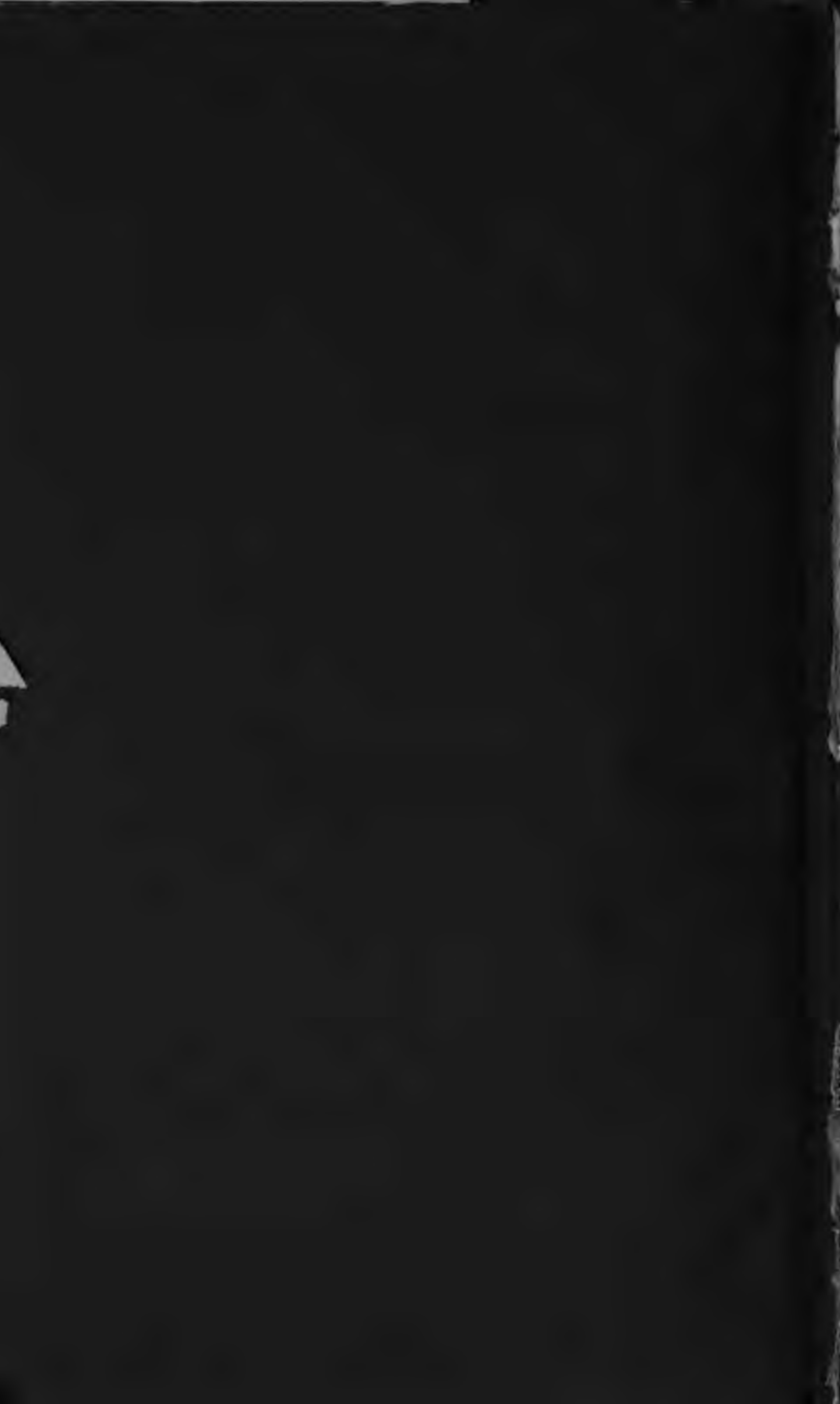



Eng 608.75
Notes on building construction,
Cabot Science

006198494



3 2044 091 847 426